



BENEITO FAURE

passion for led light



BENEITO FAURE







Projects

Our project department carries out personalized lighting solutions following international regulations for lighting comfort and visual performance. We work with enthusiasm and closeness with the customer to make every lighting project a reality. We design a preview of the project with specialized softwares for the generation of light calculations and three-dimensional images, in this way the client can anticipate how his proposal will turn out. We work through a coordinated service throughout the entire process, with a personalized approach to take care of projects down to the smallest detail.































Nuestro departamento de proyectos realiza estudios de iluminación personalizados siguiendo las normativas internacionales de confort lumínico y prestaciones visuales. Trabajamos con ilusión y cercanía con el cliente para hacer realidad cada uno de los proyectos lumínicos. Diseñamos una previsualización del proyecto con programas especializados para la generación de cálculos lumínicos e imágenes tridimensionales, de esta forma el cliente puede prever como resultará su propuesta. Trabajamos a través de un servicio coordinado a lo largo de todo el proceso, con un enfoque personalizado para cuidar hasta el mínimo detalle del resultado final.

































Private Residence, Rubí (Spain). Design: Prêt-à-porter casas.



Symbology

| | | | |
|---|---|---|---|
|  | Installation. Instalación. |  | Casambi protocol. Protocolo Casambi. |
|  | Tuya protocol. Protocolo Tuya. |  | Need Tuya Smart App to work. Necesita aplicación Tuya Smart para funcionar. |
|  | Dali protocol. Protocolo Dali. |  | Dali 2 protocol. Protocolo Dali 2. |
|  | Push. Pulsador. |  | Radio frequency. Radio frecuencia. |
|  | TRIAC Dimmable. Regulable por TRIAC. |  | 3 light intensities. 3 intensidades luminosas. |
|  | Made to measure strip LED cutting. Corte de tiras LED a medida. |  | Customized cutting and handling. Corte y manipulación personalizado. |
|  | Saline-alkali resistance. Resistencia a los álcalis salinos. |  | Anti-UV. Anti-UV. |
|  | Corrosion resisting. Resistencia a la corrosión. |  | Available colors in stock. Colores disponibles en stock. |
|  | Customizable color. Color personalizable. |  | Type of aluminium. Tipo de aluminio. |
|  | Maximum Power. Potencia Máxima. |  | Compatibility table Box-Fine. Tabla de compatibilidad Box-Fine. |
|  | Supported weight. Peso soportado. |  | Glare rating. Índice de deslumbramiento. |
|  | Color temperature selector. Selector de temperatura de color. |  | Power selector. Selector de potencia. |
|  | Color rendering index. Índice de reproducción cromática. |  | Water and dust protection. Resistencia al agua y al polvo. |
|  | Beam Angle. Ángulo de apertura. |  | Light 360°. Luz 360°. |
|  | Power Factor. Factor de Potencia. |  | Voltage. Tensión de entrada. |

| | | | |
|---|--|---|---|
|  30.000 HOURS | Lifetime. Horas de vida. |  5 YEARS WARRANTY | Warranty. Años de garantía. |
|  50/60 Hz | Hertz. Hercios. |  Class I. | Class I. Clase I. |
|  Class II. | Class II. Clase II. |  Class III. | Class III. Clase III. |
|  Do not cover. | Do not cover. No cubrir. |  2.000Kg | Supported weight. Peso soportado. |
|  CABLE 24CM | Cable length. Longitud del cable. |  +45°C -25°C | Operating Temperature. Temperatura de trabajo. |
|  >1KV | Surge protection. Protección contra sobretensiones. |  Ground slope. | Ground slope. Inclinación del suelo. |
|  IK10 | Impact resistance. Resistencia a los impactos. |  AKZO NOBEL | Anti corrosive marine paint. Pintura anticorrosión marina. |
|  Touch control. | Touch control. Control táctil. |  5W | Wireless charging. Carga inalámbrica. |
|  4-150 HOURS | Battery autonomy. Autonomía de la batería. |  2.200 mAh | Battery capacity. Capacidad de la batería. |
|  5-6 HOURS | Charging time with electricity. Tiempo de carga con corriente. |  5-6 HOURS | Charging time with sun. Tiempo de carga con sol. |
|  PIR SENSOR | Motion sensor. Detector de movimiento. |  ON OFF | Crepuscular sensor. Sensor crepuscular. |
|  1m-7m | Distance sensor. Distancia de detección. |  Gravity sensor. | Gravity sensor. Sensor gravitatorio. |
|  ENCLOSED OK | Suitable for closed luminaires. Apta para luminarias cerradas. |  8 sec 8 min | Adjustable operating time. Tiempo de encendido regulable. |
|  1/50 | Units per box (min-max). Unidades por caja. |  EMC | EMC anti-interference certification. Certificación anti interferencias EMC. |
|  Electronic waste. | Electronic waste. Residuos electrónicos. |  RoHS | Restriction of Hazardous Substances. Restricción de sustancias peligrosas. |
|  CE | European conformity. Conformidad Europea. | | |

Tuya Smart Lighting



Manage Beneito Faure luminaires with your smartphone.
Find the Tuya logo on the products with the available function.



Smartphone control

Max. 10m

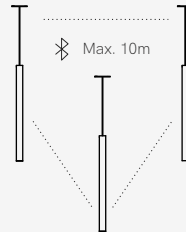

- Max. 120 devices
- Bluetooth-Mesh (Max. 30m)

Discover the multitude of functions for operating the luminaires:



On - Off



Dimmable



CCT

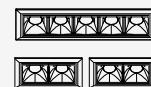

Group

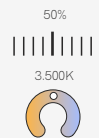

Scenes



Add more additional features with Tuya Smart Gateway.
Find the Wifi icon on the products with the available function.



Voice control or
Smartphone control



Home
Router

Gateway



(60x60x15mm)
Code: 4956

Max. 10m

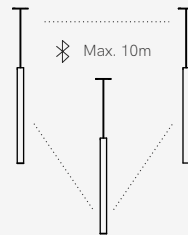

Discover the multitude of **additional functions** for operating the luminaires:



Schedule day
and time



Control from anywhere
via internet



Voice control
with Alexa



Voice control with
Google Home

Sampling & Display Stand

Discover the Beneito Faure exhibitors for our products. The three displays have been designed to appreciate the product, its application and show the lighting effect. Get in touch with our commercial department to order yours.

Descubre los expositores Beneito Faure para nuestros productos. Los tres expositores han sido diseñados para apreciar el producto, su aplicación y mostrar el efecto de iluminación. Ponte en contacto con nuestro departamento comercial para pedir el tuyo.



(113,5x38x200cm)



(42x15x35cm)



(64x40x174cm) / (64x40x213cm) with 2m profiles

Luminaires News



Time track
40



Time wall sensor
41



Forest
43



Urban track
56



Urban wall sensor
57



Urban asymmetric
58



Dau E
68

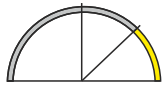

Zero design
72 / 73



Zero in
78



Zero out
80



Tubi
83



Filter
85



Grip
86



Square
87



Flash
89



Triton
90



Triton down
91

Profiles News



Box 53
113



Box 33
119



Box 39
120



Box 28
121



Box 37
122

Led strips News



Fine 51
134



Fine 32 N
142



Fine 56
144



Fine 42
147



Fine 45
155



Fine 25
164

Technical lighting News



Konic dimm
189



Three phase
track recessed
accessories
207



Pulcom trim
wood
220



Pulcom surface
accessory
222



Pulsar switch
225



Pulsar
accessories
226



Mini oxo
236 / 237

Decorative lighting **News**

Volt 48V
269

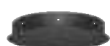

Side base
276



Front base
278



Bora
suspension
281



Bora XL
suspension
282



Zoe
285



Zoe XL
286



Nano alp
290



Alp
291



Lievo
suspension
294



Lievo XL
suspension
295



Atmos
slim 25
307



Atmos
wood
307 / 308



Volt 1
315 / 318

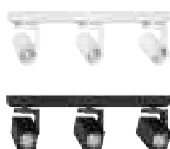

Volt 3
316 / 319



Rubyc dimm
323



Mini rubyc dimm
324



Concord dimm
327



Mini concord dimm
328



Mac wall
335



One wall
339



Zio wall
341



Lao
355



Pun
357



Stem
363



Lievo switch
365

Downlights **News**

Thessis black
375



Thessis 35W
375



Air switch
379



Noi switch
381



Avant surface
519

Rings **News**Outdoor lighting **News**

Comet
switch
415



Mini comet
switch
416



Sunset
435



Lek XL
440



Blis switch
445



Mis switch
461 / 462



Artis
465



Wech
497

Luminaires

24



Time
35



Time E
38



Time track
40



Time wall sensor
41



Forest
43



Kubo
47



Kubo-E
48



Nexus
50



Dual
51



Urban
53



Urban-E
54



Urban track
56



Urban wall sensor
57



Urban asymmetric
58



Market
59



Train
61



Fly
62



Work
63



Dau
67



Dau E
68



Zero direct
71

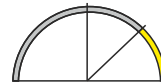

Zero design
72 / 73



Zero dual
76



Zero in
78



Zero out
80



Tubi
83



Filter
85



Grip
86



Square
87



Flash
89



Triton
90



Triton down
91

Profiles

94

Box 18
100Box 17
101Box 16
102Box 15
103Box 19
104Box 10
105Box 35
106Box 38
107Box 12
108Box 11
109Box 13
110Box 14
111Box 23
112Box 53
113Box 21
114Box 27
115Box 22
116Box 29
117Box 30
118Box 33
119Box 39
120Box 28
121Box 37
122

Led strips

124

Fine 84
131Fine 69
133Fine 51
134Fine 49
135Fine 31
136Fine 44
137Fine 41
139Fine 61
141Fine 32 N
142Fine 52
143Fine 56
144Fine 55
145Fine 36
146Fine 42
147Fine 50
148



Fine 46
149



Fine 43
151



Fine 47
152



Fine 66
153



Fine 45
155

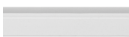

Fine 70
158

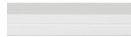

Fine 72
160

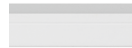

Fine 74
161



Fine 25
164



Controls
166



Xpress Casambi
167



Control Tuya
167



Control Push
/ Triac
168



Control Dali
Push Triac
168



Control Dali
Push
168



Motion Sensor
169



Power supplies 24V
170 / 171

Technical lighting

176



Sono
179



Zoom
183



Lena
185



Aston
187



Konic
189



Kom
191



Tram track
193



Alfa
195



Picolo switch
197



Picolo GU10
198 / 200



Picolo AR111
202



Three phase
track accessories
204 - 207



Three phase
base
205



Nox
209



Bonn
211



Tram recessed
213 / 214



Pulcom
217



Pulcom
asymmetric
218



Pulcom
accessories
220



Pulcom surface
accessory
222



Pulsar
225



Pulsar
accessories
226



Nano pulsar
228



Nano pulsar surface
accessory
230



Oxo
233



Mini oxo
236 / 237



Nano oxo
240



Tao
243

Decorative lighting

244



Tram 48V
249



Line 48V
251



Cookie 48V
253



Dot 48V
257



Bora 48V
259



Alp 48V
261



Zoe 48V
265



Volt 48V
269



Magnet track
accessories
270 / 271



Side base
276



Front base
278



Bora suspension
281



Bora XL suspension
282



Zoe
285



Zoe XL
286



Nano alp
290



Alp
291



Lievo suspension
294



Lievo XL suspension
295



Bora suspension
299



Bora recessed
300



Bora surface
302



Zoe
305



Atmos slim
307



Atmos switch
308



Atmos GU10
310



Ark
313



Volt 1 switch
315

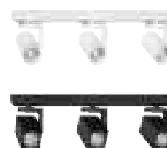

Volt 3 switch
316



Volt 1 GU10
318

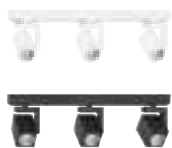

Volt 3 GU10
319



Tot
321

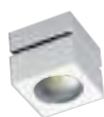

Rubyc
323



Mini rubyc
324



Concord
327



Mini concord
328



Plus
331



Mac wall
335



One wall
339



Zio wall
341



Icon
345



Sweet
347



Beam
351



Pure
353



Lao
355



Pun
357



Ilo, Skin
359



Port, Grow, Steps
360



Stem
363



Lievo
365



Converse
lighting
367

Downlights

368



Kora round
371



Kora square
372



Thessis
375 / 376



Air
379



Noi
381



Compac
383

Industrial lighting

386



Ufo lens
388 / 389



Ufo lens dali
392 / 393



Ufo
399

Outdoor lighting

400



Mac
403



Tura
407



Clos
409



Clos base
410 / 411



Comet
415



Mini comet
416



Cam
419



Neo
421



Neo XL
422



Neo sensor
424



Neo XL
426



Sigma
429



Signal
431



Gadir
433



Sunset
435



Lek
439



Lek XL
440



Blis
445



Selen
449



Zibor
451



Optic, Nix
452



Ina, Dis
453



Polo
457



Luky
459



Mis round
461



Mis square
462



Artis
465



Nik
467



Visor
469



Fix
471



Sair
473



Caddie
475

Fade
477



Zas
479



Sky with spike
481



Sky switch
483 / 484



Sky microwave
sensor
486



Sky
490



Sky 2.200K
491



Polaris
493



Krion
495



Wech
497

Solar lighting

500



Popa
503



Proa
504



Egna
507



Iris
511



Visor
513

Rings

516



Avant
519



One
521



Zio
523



Rok
525



Luk
527



Bathroom
529



Eclipse
531



Basculante
535



Fijo
537

Retrofit

538



Nitro and Dole
540



Lynk
541



Max
542



Power
543



System
544

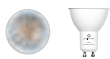

Hook
545



Uniform-line
546



Narrow
547



Tutto
548



Adn
549



Uniform-line G4
550



Uniform-line G9
551



Shop, Prisma
552



PL T40
553



Cala
554



HQI tubular
555



Lineal
556



Lineal
557



Esférica
558



Standard
559 / 560



Standard dimmable
561



Globo
562



Globo
563



Flama
564



R-63 S-line
565



Reflectors
566



Reflectors
567



Par
568



Sil
569



Aria
570



Cup
571



Moon
572



Noa
573



Smile
575



Obo
576 / 577

Luminaires

- 35. Time
- 38. Time E
- 40. Time track
- 41. Time sensor
- 43. Forest
- 47. Kubo
- 48. Kubo E
- 50. Nexus
- 51. Dual
- 53. Urban
- 54. Urban E
- 56. Urban track
- 57. Urban sensor
- 58. Urban asym.
- 59. Market
- 61. Train
- 62. Fly
- 63. Work
- 67. Dau
- 68. Dau E
- 71. Zero direct
- 72. Zero design
- 76. Zero dual
- 78. Zero in
- 80. Zero out
- 83. Tubi
- 85. Filter
- 86. Grip
- 87. Square
- 89. Flash
- 90. Triton
- 91. Triton down

The custom lighting

Beneito Faure has its own production department, an area that offers a personalized service of execution and cutting for our luminaires, led strips and profiles, in order to provide a personalized solution to the requirements of our customer. In this way, we respond to a wide range of light source needs: recessed luminaires, surface-mounted, pendant, wall-mounted, adjustable, dual-source, modular... all of them customizable. We work with a variety of LEDs (white and RGB) to obtain spectacular results, and suitable drivers for each installation. We do all of this in compliance with the strictest guidelines in aspects of certification, efficiency, sustainability and respect for the environment, which is why Beneito Faure products comply with all European standards such as RoHs, CE and EMC.

Beneito Faure cuenta con su propio departamento de producción, un área que ofrece un servicio de ejecución y corte a medida de nuestras luminarias, tiras led y perfilería, para aportar una solución personalizada a los requerimientos de nuestro cliente. De esta forma damos respuesta a una amplia gama de necesidades de fuentes de luz: luminarias para empotrar, de superficie, colgantes, de pared, orientables, de doble fuente, modulares... y todas ellas personalizables. Trabajamos con una versatilidad de leds (blancos y RGB) para obtener resultados espectaculares, y drivers adecuados para cada instalación. Todo ello lo realizamos cumpliendo con las directrices más estrictas en aspectos de certificación, eficiencia, sostenibilidad y respeto con el medio ambiente, por lo que los productos Beneito Faure cumplen con todos los estándares europeos como RoHs, CE y EMC.





Do you want a custom-made luminaire?

Look for the Cutting symbol and consult our sales department!

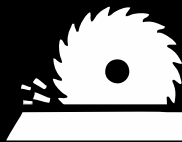

Customisation of the cut and
handling to the requested size.

















Do you want to lacquer **your luminaires**?

Look for the RAL symbol and consult our sales department!



















Customisation of the luminaire
lacquer with the requested RAL.

| Model | Page | Power | CCT | CRI |
|----------------------|------|---------------------------|---|-----------|
| TIME | 35 | 31/46/69W | 2700K 3000K 4000K 5000K | ≥95 CRI |
| TIME E | 38 | 31/46/69W | 2700K 3000K 4000K 5000K | ≥95 CRI |
| New TIME TRACK | 40 | 15/23/31W | 2700K 3000K 4000K 5000K | ≥95 CRI |
| New TIME SENSOR | 41 | 15/23/31W | 2700K 3000K 4000K 5000K | ≥95 CRI |
| New FOREST | 43 | 31/38/46/53W | 2700K 3000K 4000K 5000K CCT | ≥95 CRI |
| KUBO | 47 | 31/38/46/54W | 2700K 3000K 4000K 5000K RGB-W CCT | ≥95 CRI |
| KUBO E | 48 | 31/38/46/54W | 2700K 3000K 4000K 5000K RGB-W CCT | ≥95 CRI |
| NEXUS | 50 | 46/70W | CCT | ≥95 CRI |
| DUAL | 51 | 18-24/28-35/ 46-52W | 2700K 3000K 4000K 5000K | ≥95 CRI |
| URBAN | 53 | 46/57/69/ 80/103W | 2700K 3000K 4000K 5000K CCT | ≥95 CRI |
| URBAN E | 54 | 46/57/69/ 80/103W | 2700K 3000K 4000K 5000K CCT | ≥95 CRI |
| New URBAN TRACK | 56 | 21/32/43W | 2700K 3000K 4000K 5000K | ≥95 CRI |
| New URBAN SENSOR | 57 | 21/32/43W | 2700K 3000K 4000K 5000K | ≥95 CRI |
| New URBAN ASYMMETRIC | 58 | 46/57/69/ 80/103W | 2700K 3000K 4000K 5000K | ≥95 CRI |
| MARKET | 59 | 45/55,5/66/ 76,5/97,5W | 3000K MEAT R HAM MEAT M 4000K FISH FRUIT BREAD | 80/93 CRI |

| Installation | Section Size | IP | Standard finishes |
|---|--------------|-------|--|
|  Surface / Pendant | 39x75 mm | 40 IP | White Black Gray |
|  Recessed | 54x75 mm | 40 IP | White Black Gray |
|  Track | 39x75 mm | 20 IP | White Black |
|  Wall | 39x75 mm | 20 IP | White Black Gray |
|  Pendant | 64x95 mm | 40 IP | Wood |
|  Pendant | 35x35 mm | 20 IP | White Black |
|  Recessed | 50x35 mm | 20 IP | White Black |
|  Pendant | 39x75 mm | 40 IP | White Black Gray |
|  Pendant | 39x125 mm | 40 IP | White Black |
|  Surface / Pendant | 58x68 mm | 40 IP | White Black Gray Gold Corten Copper |
|  Recessed | 75x68 mm | 40 IP | White Black Gray |
|  Track | 58x68 mm | 20 IP | White Black |
|  Wall | 58x68 mm | 20 IP | White Black Gray |
|  Surface / Pendant | 58x68 mm | 40 IP | White |
|  Surface / Pendant | 58x68 mm | 40 IP | White Black |

| | Model | Page | Power | CCT | CRI |
|-----|-------------|------|-----------------------|-----------------------------------|------------|
| | TRAIN | 61 | 46/57/69/80W | 2700K 3000K 4000K 5000K | ≥95 CRI |
| | FLY | 62 | 2x14/3x14W | 3000K 4000K | ≥95 CRI |
| | WORK | 63 | 35/43/51/ 59/97,5W | 2700K 3000K 4000K 5000K | ≥95 CRI |
| | DAU | 67 | 18/23/26/30W | 2700K 3000K 4000K 5000K RGB-W CCT | ≥90 CRI |
| New | DAU E | 68 | 18/23/26/30W | 2700K 3000K 4000K 5000K RGB-W CCT | ≥90 CRI |
| | ZERO DIRECT | 71 | 43/81/162W | 2700K 3000K 4000K CCT | ≥80 CRI |
| | ZERO DUAL | 76 | 107/162/325W | 3000K 4000K | ≥80 CRI |
| New | ZERO IN | 78 | 26/44/63W | 2700K 3000K 4000K RGB-W CCT | ≥90 CRI |
| New | ZERO OUT | 80 | 26/44/63W | 2700K 3000K 4000K RGB-W CCT | ≥90 CRI |
| New | TUBI | 83 | 35/44/53/62W | 2700K 3000K 4000K 5000K RGB-W CCT | ≥90 CRI |
| New | FILTER | 85 | 32/48/64/80W | 2700K 3000K 4000K RGB | ≥90 CRI |
| New | GRIP | 86 | 26/33/39/46W | 2700K 3000K 4000K RGB CCT | ≥90 CRI |
| New | SQUARE | 87 | 43/62W | 2700K 3000K 4000K RGB-W CCT | ≥90 CRI |
| New | FLASH | 89 | 16/27/35/46/55W | 2700K 3000K 4000K 6000K | ≥80 CRI |
| New | TRITON | 90 | 27/54/81W | 2700K 3000K 4000K | ≥80 CRI |
| New | TRITON DOWN | 91 | 46/57/69/80/103W | 2700K 3000K 4000K 6000K | ≥95 CRI |

| Installation | Section Size | IP | Standard finishes |
|---|--------------|-------|-------------------------|
|  Pendant | 58x68 mm | 40 IP | White Black |
|  Pendant | 58x68 mm | 40 IP | White Black |
|  Pendant | 58x68 mm | 40 IP | White Black |
|  Pendant | 25x25 mm | 20 IP | White Black |
|  Recessed | 35x25 mm | 20 IP | White Black |
|  Pendant | 35x35 mm | 20 IP | White Black Gold Silver |
|  Pendant | 50x60 mm | 20 IP | White Black |
|  Pendant | 12x30 mm | 20 IP | White Black Gold Silver |
|  Pendant | 12x30 mm | 20 IP | White Black Gold Silver |
|  Pendant | Ø62 mm | 40 IP | White Black |
|  Pendant | Ø60 mm | 20 IP | White Black |
|  Pendant | Ø28 mm | 40 IP | Black |
|  Pendant | 25x25 mm | 40 IP | White Black Gold Silver |
|  Wall | 17,8x48,6 mm | 20 IP | White Black Alum. |
|  Surface | 47x66 mm | 65 IP | Black |
|  Surface / Pendant | 47x66 mm | 65 IP | White Black |



Time

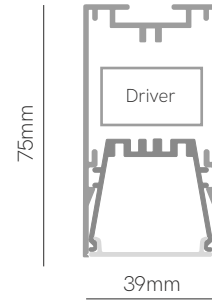

Technical Information

| | |
|--------------|---|
| Version | Time |
| Power | 31W / 46W / 69W |
| Installation | Surface / Pendant |
| Material | Aluminium |
| Finishes | White (9003) / Black (9005) / Gray (9006) |

| Code | Diffuser (Angle) | Power (Size) | CCT (lm/W) | Driver | Colour |
|---------------|----------------------|------------------------|----------------------------|-------------------|------------------|
| Code 8 | UGR (81°) 3 | 31W (1.130mm) 3 | 2.700K (112 lm/W) 2 | On / Off 1 | □ White 1 |
| | Opal (112°) 5 | 46W (1.690mm) 5 | 3.000K (128 lm/W) 3 | Dali 2 | ■ Black 2 |
| | | 69W (2.530mm) 7 | 4.000K (136 lm/W) 4 | Push 3 | ■ Gray 3 |
| | | | 5.000K (136 lm/W) 5 | Casambi 5 | |

Code: **8** ■ ■ ■ ■ ■

*Create your code according to your preferences.

Accessories

| | | | | | | | | |
|---|-----------------------|----------------------|---|---------------------|---|--|-------------------------------|--------------------------------|
| | | | | | | | | |
| End caps □ 40741 ■ 40742 ■ 40743 | Joint 180° ■ 40770 | Joint 90° ■ 40990 | Wall bracket □ 40851 ■ 40852 ■ 40853 | Trimless ■ 40339 | Base 3x0,75 (2,5m) Ø60x28mm □ 40881 ■ 40882 ■ 40883 | Base 5x0,5 (2,5m) Ø60x28mm □ 40991 ■ 40992 ■ 40993 | Ceiling suspension ■ 40780 | Suspension kit ■ 40790 (2m) |

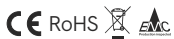



5 YEARS WARRANTY | 50.000 HOURS | IP 40 | UGR <19 (3) | 230 VAC | PF >0,9 | CRI >95 |
 |
 |
 |
 3,37m Max |
 |
 |
 |
 PUSH |



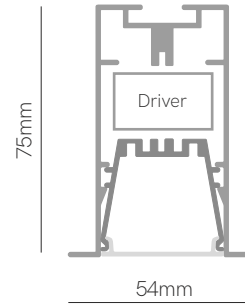

Time E



 43mm x L



*Spring clips included.

Technical Information

| | |
|--------------|---|
| Version | Time E |
| Power | 31W / 46W / 69W |
| Installation | Recessed |
| Material | Aluminium |
| Finishes | White (9003) / Black (9005) / Gray (9006) |

| Code | Diffuser (Angle) | Power (Size) | CCT (lm/W) | Driver | Colour |
|---------------|----------------------|------------------------|-----------------------------------|-------------------|--|
| Code 9 | UGR (81°) 3 | 31W (1.130mm) 3 | 2.700K (112 lm/W) 2 | On / Off 1 | <input type="checkbox"/> White 1 |
| | Opal (112°) 5 | 46W (1.690mm) 5 | 3.000K (128 lm/W) 3 | Dali 2 | <input checked="" type="checkbox"/> Black 2 |
| | | 69W (2.530mm) 7 | 4.000K (136 lm/W) 4 | Push 3 | <input type="checkbox"/> Gray 3 |
| | | | 5.000K (136 lm/W) 5 | Casambi 5 | |

Code: **9**

*Create your code according to your preferences.

Accessories



End caps
 40751
 40752
 40753

Joint 180°
 40770

Joint 90°
 40990



5 YEARS WARRANTY | 50.000 HOURS | IP 40 | UGR <19 (3) | 230 VAC | PF >0,9 | CRI ≥95 |  |  | 3,37m Max |  |  |  | PUSH | 



New

Time track

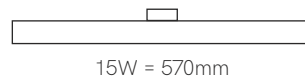
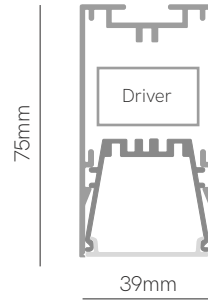

*Finished luminaire. Includes power supply and track adapter.

Technical Information

| | |
|--------------|-----------------------------|
| Version | Time track |
| Power | 15W / 23W / 31W |
| Installation | Three Phase Track |
| Material | Aluminium |
| Finishes | White (9003) / Black (9005) |

| Code | Diffuser (Angle) | Power (Size) | CCT (Lm/W) | Driver | Colour |
|---------------|----------------------|------------------------|----------------------------|-------------------|----------------|
| Code 8 | UGR (81°) 3 | 15W (570mm) 4 | 2.700K (112 lm/W) 2 | On / Off 4 | White 1 |
| | Opal (112°) 5 | 23W (840mm) 6 | 3.000K (128 lm/W) 3 | Casambi 6 | Black 2 |
| | | 31W (1.130mm) 8 | 4.000K (136 lm/W) 4 | | |
| | | | 5.000K (136 lm/W) 5 | | |

Code: **8**

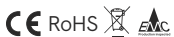

*Create your code according to your preferences.



New

Time wall sensor

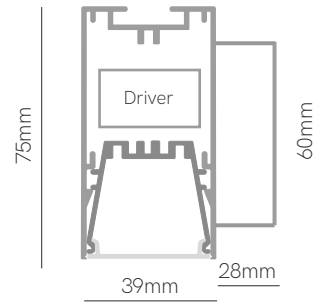

*Finished luminaire. Includes power supply, base and end caps .

Technical Information

| | |
|--------------|---|
| Version | Time wall sensor |
| Power | 15W / 23W / 31W |
| Installation | Wall |
| Material | Aluminium |
| Finishes | White (9003) / Black (9005) / Gray (9006) |

| Code | Diffuser (Angle) | Power (Size) | CCT (Lm/W) | Driver | Colour |
|---------------|----------------------|------------------------|-----------------------------------|--------------|--|
| Code 8 | Opal (112°) 1 | 15W (570mm) 1 | 2.700K (112 lm/W) 2 | PIR 0 | <input type="checkbox"/> White 1 |
| | | 23W (840mm) 2 | 3.000K (128 lm/W) 3 | | <input checked="" type="checkbox"/> Black 2 |
| | | 31W (1.130mm) 3 | 4.000K (136 lm/W) 4 | | <input type="checkbox"/> Gray 3 |
| | | | 5.000K (136 lm/W) 5 | | |

Code: **8** **1** **0**



*Create your code according to your preferences.

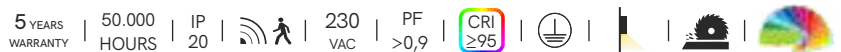



New

Forest

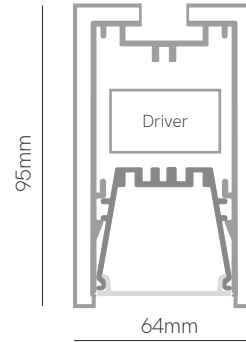

*Finished luminaire. Includes power supply, suspension kit, power cable and end caps.

Technical Information

| | |
|--------------|-----------------------|
| Version | Forest |
| Power | 31W / 38W / 46W / 53W |
| Installation | Pendant |
| Material | Aluminium |
| Finishes | Wood |

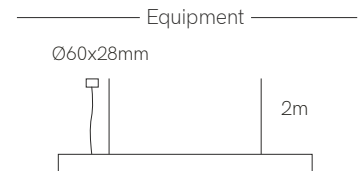

| Code | Diffuser (Angle) | Power (Size) | CCT (Lm/W) | Driver | Colour |
|---------------|----------------------|------------------------|---|-------------------|----------------------|
| Code 4 | UGR (81°) 3 | 31W (1.155mm) 3 | 2.700K (112 lm/W) 2 | On / Off 1 | Wood 8 |
| | Opal (112°) 5 | 38W (1.435mm) 4 | 3.000K (128 lm/W) 3 | Dali 2 | |
| | | 46W (1.715mm) 5 | 4.000K (136 lm/W) 4 | Push 3 | |
| | | 53W (1.995mm) 6 | 5.000K (136 lm/W) 5 | Casambi 5 | |
| | | | 2.700-5.000K (105 lm/W) 9 | Tuya 7 | |

Code: **4** **8**



*Create your code according to your preferences.







Showroom Benito Faure, La Roca del Valles (Spain).



Arce Pharmacy, A Coruña (Spain). Design: Sabina Arquitectos. Lighting Design: Pérez Antolín. Photography: Paco Rocha.

Kubo

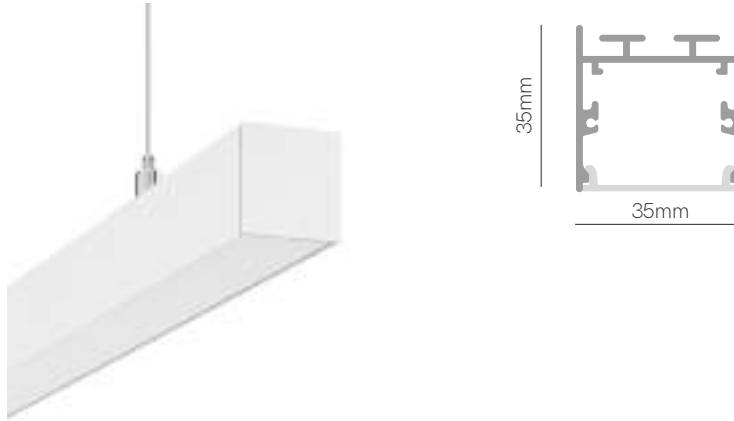

*Finished luminaire. Includes power supply, suspension kit, power cable and end caps.

Technical Information

| | |
|--------------|-----------------------------|
| Version | Kubo |
| Power | 31W / 38W / 46W / 54W |
| Installation | Pendant |
| Material | Aluminium |
| Finishes | White (9003) / Black (9005) |

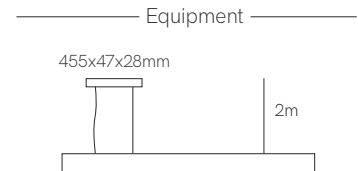

| Code | Diffuser (Angle) | Power (Size) | CCT (Lm/W) | Driver | Colour |
|---------------|----------------------|------------------------|---|-------------------|------------------|
| Code 7 | Opal (100°) 5 | 31W (1.130mm) 3 | 2.700K (112 lm/W) 2 | On / Off 1 | □ White 1 |
| | | 38W (1.410mm) 4 | 3.000K (128 lm/W) 3 | Dali 2 | ■ Black 2 |
| | | 46W (1.690mm) 5 | 4.000K (136 lm/W) 4 | Push 3 | |
| | | 54W (1.970mm) 6 | 5.000K (136 lm/W) 5 | Casambi 5 | |
| | | | RGB-W (172 lm/W) 8 | Tuya 7 | |
| | | | 2.700-5.000K (105 lm/W) 9 | | |

Code: **7** **5** ■ ■ ■ ■ ■



*Create your code according to your preferences. RGB-W and CCT 2.700-5.000K only works with driver Casambi and Tuya.



Kubo E

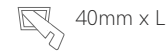
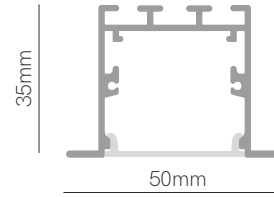

*Finished luminaire. Includes power supply, spring clips, power cable and end caps.

Technical Information

| | |
|--------------|-----------------------------|
| Version | Kubo E |
| Power | 31W / 38W / 46W / 54W |
| Installation | Recessed |
| Material | Aluminium |
| Finishes | White (9003) / Black (9005) |

| Code | Diffuser (Angle) | Power (Size) | CCT (Lm/W) | Driver | Colour | | | | | | |
|------|------------------|---------------|------------|--------------------|----------|-------------------|----------|----------|----------|---------|----------|
| Code | 5 | Opal (100°) | 5 | 31W (1.130mm) | 3 | 2.700K (112 lm/W) | 2 | On / Off | 1 | □ White | 1 |
| | | 38W (1.410mm) | 4 | 3.000K (1128 lm/W) | 3 | Dali | 2 | ■ Black | 2 | | |
| | | 46W (1.690mm) | 5 | 4.000K (136 lm/W) | 4 | Push | 3 | | | | |
| | | 54W (1.970mm) | 6 | 5.000K (136 lm/W) | 5 | Casambi | 5 | | | | |
| | | | | RGB-W (172 lm/W) | 8 | Tuya | 7 | | | | |
| | | | | CCT (105 lm/W) | 9 | | | | | | |

Code: **5** **5**

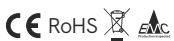

*Create your code according to your preferences. RGB-W and CCT only works with driver 5 and 7.



Dental Clinic Eva Flores, El Prat de Llobregat (Spain). Design: Meumstudio.



Nexus

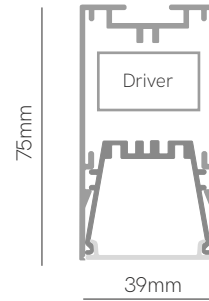

*Finished luminaire. Includes suspension kit, power cable and end caps.

Technical Information

| | |
|--------------|-----------------------------|
| Version | Nexus |
| Power | 46W / 70W |
| Installation | Pendant |
| Material | Aluminium |
| Finishes | White (9003) / Black (9005) |

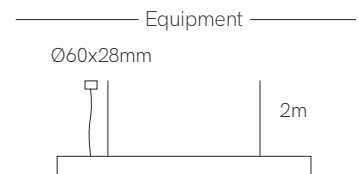

| Code | Diffuser (Angle) | Power (Size) | CCT (Lm/W) | Driver | Colour |
|---------------|--------------------|------------------------|----------------------------------|---------------------|----------------|
| Code 4 | UGR (81°) 4 | 46W (1.130mm) 3 | 2.700-5.000K (105 lm/W) 9 | Casambi 5 | White 1 |
| | | 70W (1.690mm) 5 | | Tuya 7 | Black 2 |
| | | | | RF Control 9 | Gray 3 |

Code: 4 4 9

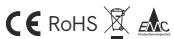

*Create your code according to your preferences. RF included on Driver RF Control.

5 YEARS WARRANTY | 50.000 HOURS | IP 40 | UGR <19 | 230 VAC | PF >0,9 | CRI ≥95 | | | 3,37m Max | | | | RF

Dual

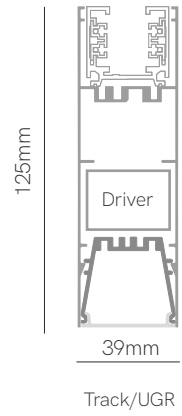
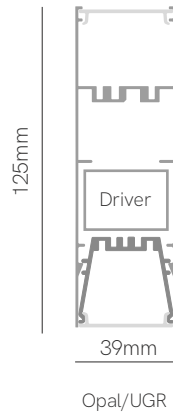

*Finished luminaire. Includes suspension kit, power cable and end caps.

Technical Information

| | |
|--------------|-----------------------------|
| Version | Dual |
| Power | 18-24W / 28-35W / 46-52W |
| Installation | Pendant |
| Material | Aluminium |
| Finishes | White (9003) / Black (9005) |

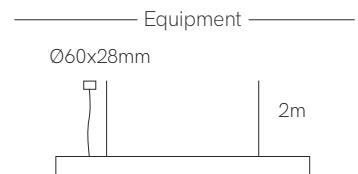

| Code | Diffuser | Power Up-Down (Size) | CCT (Lm/W) | Driver | Colour |
|---------------|--------------------|---------------------------|----------------------------|-------------------|------------------|
| Code 5 | Opal/UGR 6 | 18-24W (1.130mm) 3 | 2.700K (112 lm/W) 2 | On / Off 1 | □ White 1 |
| | Track/UGR 9 | 28-35W (1.690mm) 5 | 3.000K (128 lm/W) 3 | Dali 2 | ■ Black 2 |
| | | 46-52W (2.530mm) 7 | 4.000K (136 lm/W) 4 | Push 3 | |
| | | | 5.000K (136 lm/W) 5 | Casambi 5 | |

Code: **5** ■ ■ ■ ■ ■

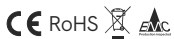

*Create your code according to your preferences.

5 YEARS WARRANTY | 50.000 HOURS | IP 40 | UGR <19 | 230 VAC | PF >0,9 | CRI ≥95 | [Grounding symbol] | [Light fixture symbol] | 3,37m Max | [Saw blade symbol] | [Fire symbol] | [PUSH button symbol] | [DALI 2 logo]

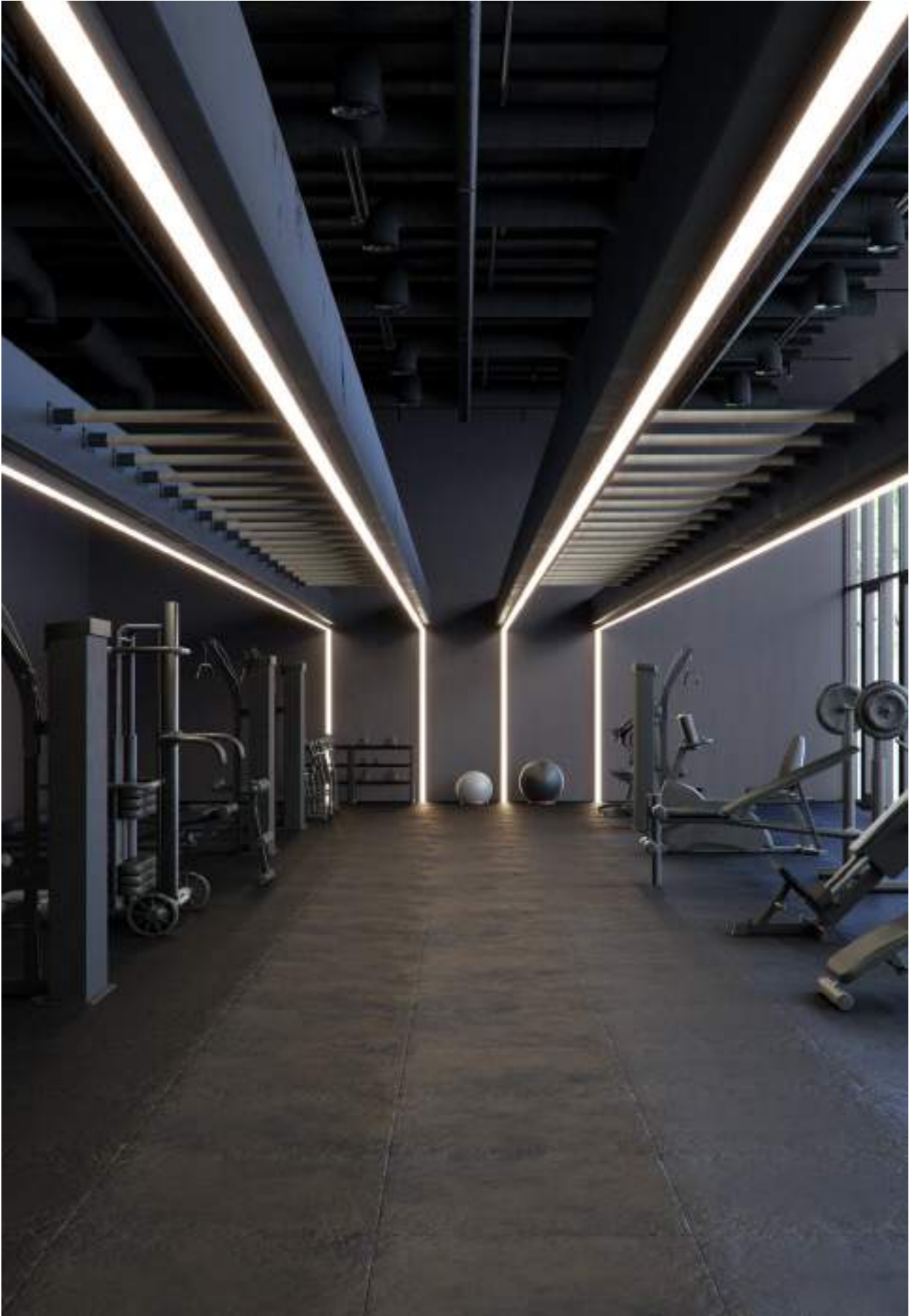

Urban

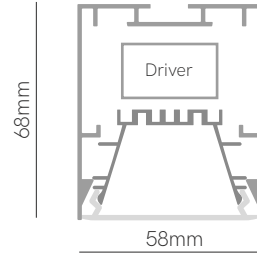

Technical Information

| | |
|--------------|---|
| Version | Urban |
| Power | 46W / 57W / 69W / 80W / 103W |
| Installation | Surface / Pendant |
| Material | Aluminium |
| Finishes | White (9003) / Black (9005) / Gray (9006) |

| Code | Diffuser (Angle) | Power (Size) | CCT (Lm/W) | Driver | Colour |
|------|----------------------|-------------------------|----------------------------------|----------------------------|--------------------|
| Code | 6 | UGR (78°) 4 | 46W (1.130mm) 3 | 2.700K (112 lm/W) 2 | On / Off 1 |
| | Opal (112°) 5 | 57W (1.410mm) 4 | 3.000K (128 lm/W) 3 | Dali 2 | White 1 |
| | | 69W (1.690mm) 5 | 4.000K (136 lm/W) 4 | Push 3 | Black 2 |
| | | 80W (1.970mm) 6 | 5.000K (136 lm/W) 5 | Casambi 5 | Gray 3 |
| | | 103W (2.530mm) 7 | 2.700-5.000K (105 lm/W) 9 | Tuya 7 | Matt Gold 4 |
| | | | | | Corten 6 |
| | | | | | Copper 7 |

Code: **6** ■ ■ ■ ■ ■

ⓘ On demand.

*Create your code according to your preferences. CCT 2.700-5.000K only works with driver Casambi and Tuya.

Accessories

| | | | | | | | | |
|---|-----------------------|----------------------|---|---------------------|---|--|-------------------------------|--------------------------------|
| | | | | | | | | |
| End caps □ 40721 ■ 40722 ■ 40723 | Joint 180° ■ 40220 | Joint 90° ■ 40550 | Wall bracket □ 40851 ■ 40852 ■ 40853 | Trimless ■ 40669 | Base 3x0,75 (2,5m) Ø60x28mm □ 40881 ■ 40882 ■ 40883 | Base 5x0,5 (2,5m) Ø60x28mm □ 40991 ■ 40992 ■ 40993 | Ceiling suspension ■ 40780 | Suspension Kit ■ 40790 (2m) |



Urban E

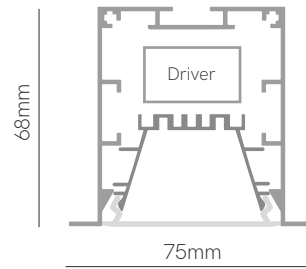

*Spring clips included.

Technical Information

| | |
|--------------|---|
| Version | Urban E |
| Power | 46W / 57W / 69W / 80W / 103W |
| Installation | Recessed |
| Material | Aluminium |
| Finishes | White (9003) / Black (9005) / Gray (9006) |

| Code | Diffuser (Angle) | Power (Size) | CCT (Lm/W) | Driver | Colour |
|---------------|----------------------|-------------------------|----------------------------------|-------------------|----------------|
| Code 3 | UGR (78°) 4 | 46W (1.130mm) 3 | 2.700K (112 lm/W) 2 | On / Off 1 | White 1 |
| | Opal (112°) 5 | 57W (1.410mm) 4 | 3.000K (128 lm/W) 3 | Dali 2 | Black 2 |
| | | 69W (1.690mm) 5 | 4.000K (136 lm/W) 4 | Push 3 | Gray 3 |
| | | 80W (1.970mm) 6 | 5.000K (136 lm/W) 5 | Casambi 5 | |
| | | 103W (2.530mm) 7 | 2.700-5.000K (105 lm/W) 9 | Tuya 7 | |

Code: **3** ■ ■ ■ ■ ■

*Create your code according to your preferences. CCT 2.700-5.000K only works with driver Casambi and Tuya.

Accessories



End caps
 □ 40731
 ■ 40732
 □ 40733

Joint 180°
 ■ 40220

Joint 90°
 ■ 40550

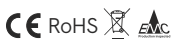



New

Urban track

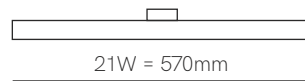
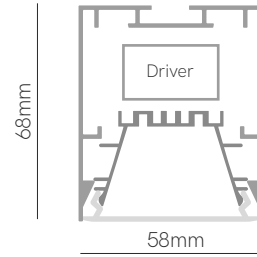

*Finished luminaire. Includes power supply and track adapter.

Technical Information

| | |
|--------------|-----------------------------|
| Version | Urban track |
| Power | 21W / 32W / 43W |
| Installation | Three Phase Track |
| Material | Aluminium |
| Finishes | White (9003) / Black (9005) |

| Code | Diffuser (Angle) | Power (Size) | CCT (lm/W) | Driver | Colour |
|---------------|----------------------|------------------------|---|-------------------|------------------|
| Code 6 | UGR (78°) 4 | 21W (570mm) 4 | 2.700K (112 lm/W) 2 | On / Off 4 | □ White 1 |
| | Opal (112°) 5 | 32W (840mm) 6 | 3.000K (128 lm/W) 3 | Casambi 6 | ■ Black 2 |
| | | 43W (1.130mm) 8 | 4.000K (136 lm/W) 4 | | |
| | | | 5.000K (136 lm/W) 5 | | |
| | | | 2.700-5.000K (105 lm/W) 9 | | |

Code: **6** ■ ■ ■ ■ ■

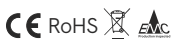

*Create your code according to your preferences.



New

Urban wall sensor

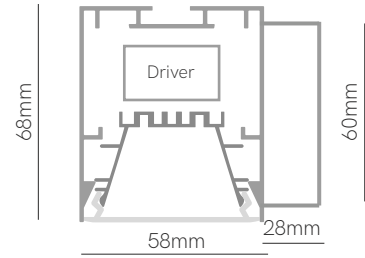

*Finished luminaire. Includes power supply, base and end caps.

Technical Information

| | |
|--------------|---|
| Version | Urban wall sensor |
| Power | 21W / 32W / 43W |
| Installation | Wall |
| Material | Aluminium |
| Finishes | White (9003) / Black (9005) / Gray (9006) |

| Code | Diffuser (Angle) | Power (Size) | CCT (Lm/W) | Driver | Colour |
|---------------|----------------------|------------------------|-----------------------------------|--------------|--|
| Code 6 | Opal (112°) 1 | 21W (570mm) 1 | 2.700K (112 lm/W) 2 | PIR 0 | <input type="checkbox"/> White 1 |
| | | 32W (840mm) 2 | 3.000K (128 lm/W) 3 | | <input checked="" type="checkbox"/> Black 2 |
| | | 43W (1.130mm) 3 | 4.000K (136 lm/W) 4 | | <input type="checkbox"/> Gray 3 |
| | | | 5.000K (136 lm/W) 5 | | |

Code: **6** **1** **0**



*Create your code according to your preferences.

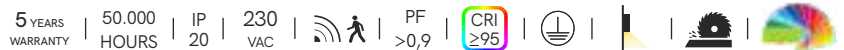

New

Urban asymmetric

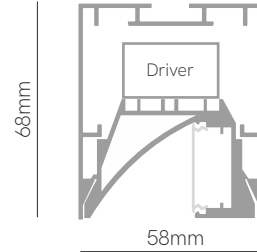

Technical Information

| | |
|--------------|---|
| Version | Urban asymmetric |
| Power | 46W / 57W / 69W / 80W / 103W |
| Installation | Surface / Pendant |
| Material | Aluminium |
| Finishes | White (9003) / Black (9005) / Gray (9006) |

| Code | Diffuser (Angle) | Power (Size) | CCT (Lm/W) | Driver | Colour |
|---------------|---------------------|-------------------------|----------------------------|-------------------|---|
| Code 6 | Opal asym. 8 | 46W (1.130mm) 3 | 2.700K (112 lm/W) 2 | On / Off 1 | <input type="checkbox"/> White 1 |
| | | 57W (1.410mm) 4 | 3.000K (128 lm/W) 3 | Dali 2 | |
| | | 69W (1.690mm) 5 | 4.000K (136 lm/W) 4 | Push 3 | |
| | | 80W (1.970mm) 6 | 5.000K (136 lm/W) 5 | Casambi 5 | |
| | | 103W (2.530mm) 7 | | | |

Code: **6** **8** **1**

*Create your code according to your preferences.

Accessories

| | | | | | | |
|--|--|---|--|---|--|---|
| | | | | | | |
| End caps <input type="checkbox"/> 40721 <input type="checkbox"/> 40722 <input type="checkbox"/> 40723 | Joint 180° <input type="checkbox"/> 40220 | Joint 90° <input type="checkbox"/> 40550 | Base 3x0,75 (2,5m) Ø60x28mm <input type="checkbox"/> 40881 | Base 5x0,5 (2,5m) Ø60x28mm <input type="checkbox"/> 40991 | Ceiling suspension <input type="checkbox"/> 40780 | Suspension Kit <input type="checkbox"/> 40790 (2m) |

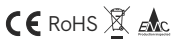

5 YEARS WARRANTY | 50.000 HOURS | IP 40 | UGR <19 | 230 VAC | PF >0,9 | CRI ≥95 | | | | 3,37m Max | | | | PUSH |

Market

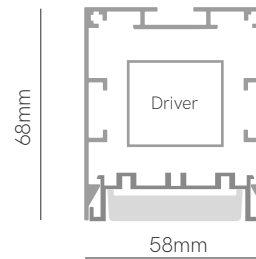

Technical Information







| | |
|--------------|-----------------------------------|
| Version | Market |
| Power | 45W / 55,5W / 66W / 76,5W / 97,5W |
| Installation | Surface / Pendant |
| Material | Aluminium |
| Finishes | White (9003) / Black (9005) |

| Code | Diffuser (Angle) | Power (Size) | CCT (Lm/W) | Driver | Colour |
|---------------|------------------------|--------------------------|------------------------------------|-------------------|--|
| Code 2 | Asymmetric 1 | 45W (1.130mm) 3 | 3.000K (112 lm/W) 3 | On / Off 1 | <input type="checkbox"/> White 1 |
| | Double asym. 2 | 55,5W (1.410mm) 4 | 4.000K (118 lm/W) 4 | Dali 2 | <input checked="" type="checkbox"/> Black 2 |
| | Optical (30°) 3 | 66W (1.690mm) 5 | MEAT R - 3.200K (86 lm/W) R | | |
| | Optical (60°) 6 | 76,5W (1.970mm) 6 | HAM - 3.200K (85 lm/W) X | | |
| | Optical (90°) 9 | 97,5W (2.530mm) 7 | MEAT M - 3.500K (84 lm/W) M | | |
| | | | FISH - 6.500K (139 lm/W) F | | |
| | | | FRUIT - 4.200K (123 lm/W) V | | |
| | | | BREAD - 2.700K (131 lm/W) P | | |

Code: **2**

*Create your code according to your preferences.

Accessories

- 
 End caps
 40721
 40722
- 
 Joint 180°
 40220
- 
 Joint 90°
 40550
- 
 Base 3x0,75 (2,5m)
 Ø60x28mm
 40881
 40882
- 
 Base 5x0,5 (2,5m)
 Ø60x28mm
 40991
 40992
- 
 Ceiling suspension
 40780
- 
 Suspension Kit
 40790 (2m)

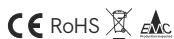

5 YEARS WARRANTY | 50.000 HOURS | IP 40 | 230 VAC | PF >0,9 | CRI 80/93 |  |  |  | 3,37m Max   

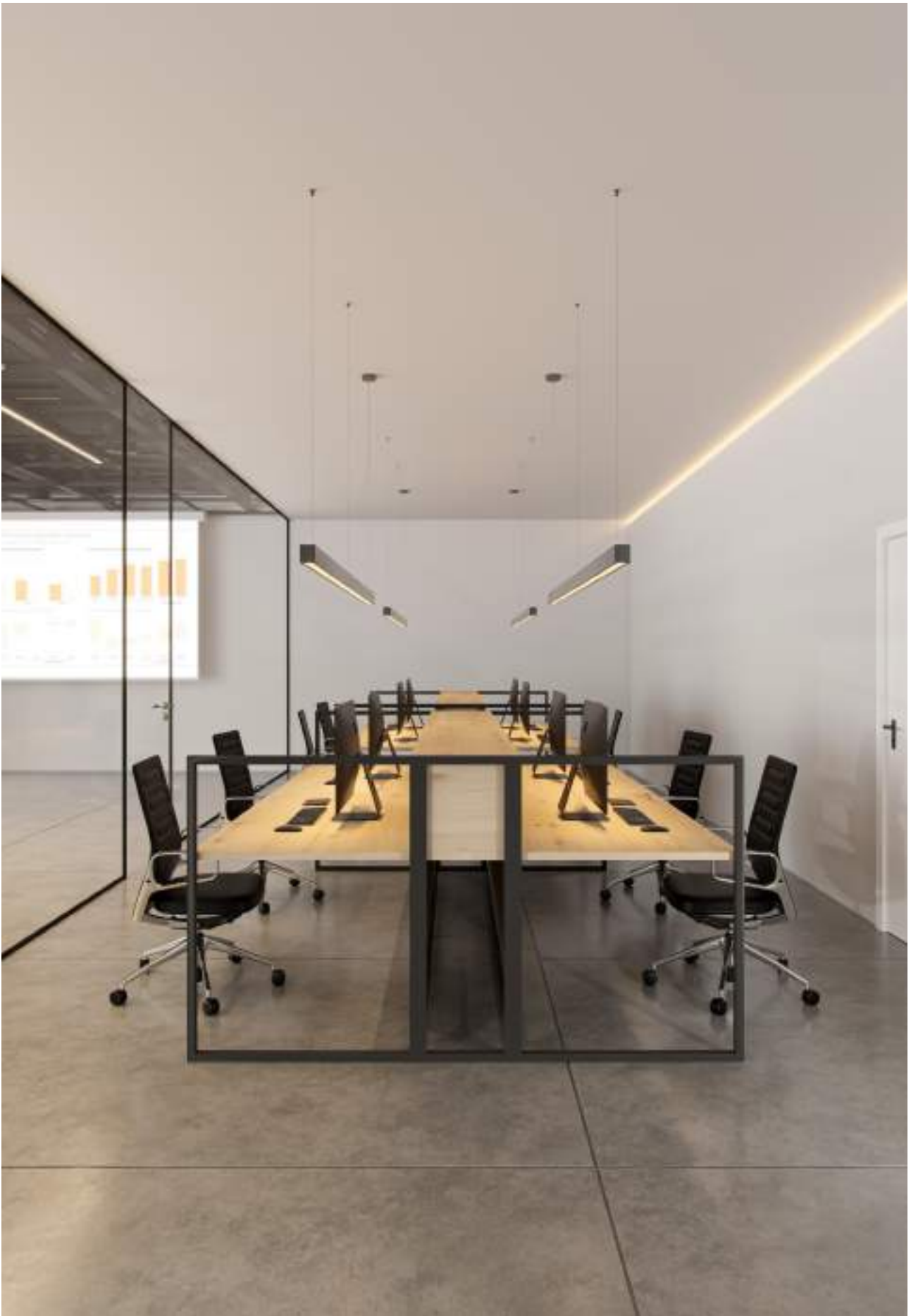

Train

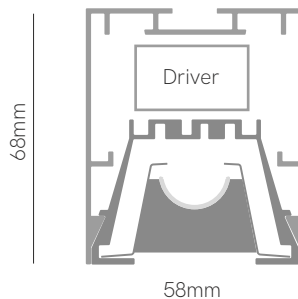

*Finished luminaire. Includes suspension kit, power cable and end caps.

Technical Information

| | |
|--------------|-----------------------------|
| Version | Train |
| Power | 46W / 57W / 69W / 80W |
| Installation | Pendant |
| Material | Aluminium |
| Finishes | White (9003) / Black (9005) |

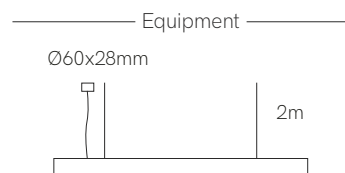

| Code | Diffuser (Angle) | Power (Size) | CCT (Lm/W) | Driver | Colour |
|---------------|----------------------------|------------------------|-----------------------------------|-------------------|------------------|
| Code 6 | Black Slats (62°) 2 | 46W (1.130mm) 3 | 2.700K (112 lm/W) 2 | On / Off 1 | □ White 1 |
| | Alum. Slats (84°) 7 | 57W (1.410mm) 4 | 3.000K (128 lm/W) 3 | Dali 2 | ■ Black 2 |
| | | 69W (1.690mm) 5 | 4.000K (136 lm/W) 4 | Push 3 | |
| | | 80W (1.970mm) 6 | 5.000K (136 lm/W) 5 | Casambi 5 | |

Code: **6** ■ ■ ■ ■ ■

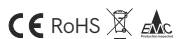

*Create your code according to your preferences.

5 YEARS WARRANTY | 50.000 HOURS | IP 40 | UGR <19 | 230 VAC | PF >0,9 | CRI ≥95 | [Grounding symbol] | [Hanging luminaire symbol] | 3,37m Max | [Saw blade symbol] | [Color wheel symbol] | [DALI symbol] | [A symbol] | [PUSH button symbol] | [DALI 2 symbol]

Fly

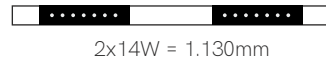
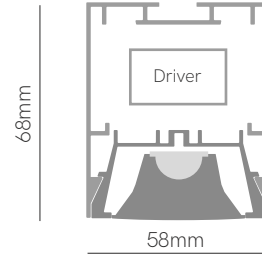

*Finished luminaire. Includes suspension kit, power cable and end caps.

Technical Information

| | |
|--------------|-----------------------------|
| Version | Fly |
| Power | 2x14W / 3x14W |
| Installation | Pendant |
| Material | Aluminium |
| Finishes | White (9003) / Black (9005) |

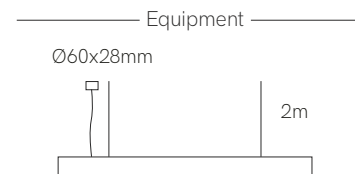

| Code | Diffuser (Angle) | Power (Size) | CCT (Lm/W) | Driver | Colour |
|---------------|------------------------|--------------------------|-----------------------------------|-------------------|------------------|
| Code 6 | Optical (50°) 9 | 2x14W (1.130mm) 4 | 3.000K (130 lm/W) 3 | On / Off 1 | □ White 1 |
| | | 3x14W (1.690mm) 5 | 4.000K (136 lm/W) 4 | Dali 2 | ■ Black 2 |
| | | | | Push 3 | |
| | | | | Casambi 5 | |

Code: **6 9** ■ ■ ■ ■ ■

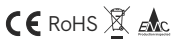

*Create your code according to your preferences.



Work

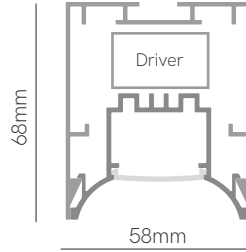

*Finished luminaire. Includes suspension kit, power cable and end caps.

Technical Information

| | |
|--------------|-------------------------------|
| Version | Work |
| Power | 35W / 43W / 51W / 59W / 97,5W |
| Installation | Pendant |
| Material | Aluminium |
| Finishes | White (9003) / Black (9005) |

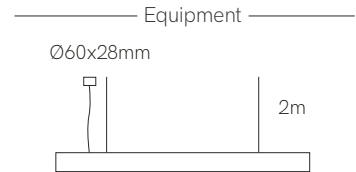

| Code | Diffuser (Angle) | Power (Size) | CCT (Lm/W) | Driver | Colour |
|---------------|---------------------------|--------------------------|-----------------------------------|-------------------|------------------|
| Code 6 | Retracted (102°) 3 | 35W (1.130mm) 3 | 2.700K (105 lm/W) 2 | On / Off 1 | □ White 1 |
| | | 43W (1.410mm) 4 | 3.000K (112 lm/W) 3 | Dali 2 | ■ Black 2 |
| | | 51W (1.690mm) 5 | 4.000K (118 lm/W) 4 | Push 3 | |
| | | 59W (1.970mm) 6 | 5.000K (118 lm/W) 5 | Casambi 5 | |
| | | 97,5W (2.530mm) 7 | | | |

Code: **6** **3** ■ ■ ■ ■ ■



*Create your code according to your preferences.









Dau

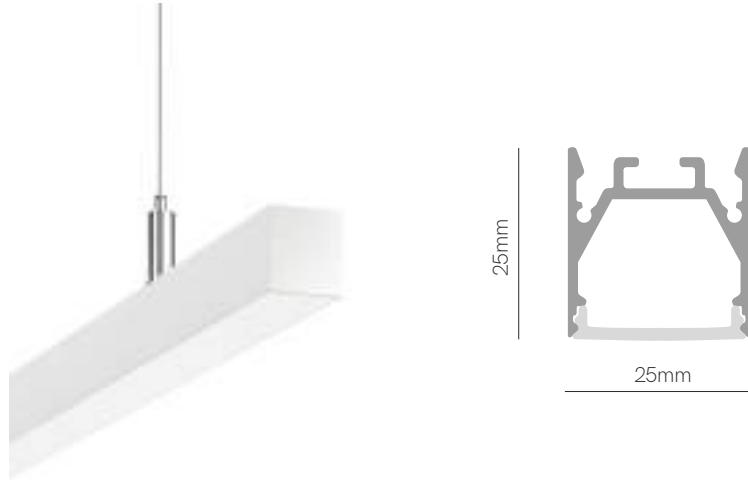

*Finished luminaire. Includes suspension kit, power cable and end caps.

Technical Information

| | |
|--------------|-----------------------------|
| Version | Dau |
| Power | 18W / 23W / 26W / 30W |
| Installation | Pendant |
| Material | Aluminium |
| Finishes | White (9003) / Black (9005) |

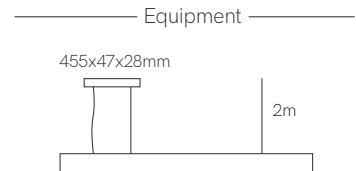

| Code | Diffuser (Angle) | Power (Size) | CCT (Lm/W) | Driver | Colour |
|---------------|----------------------|------------------------|----------------------------|-------------------|----------------|
| Code 1 | Opal (110°) 5 | 18W (1.170mm) 3 | 2.700K (100 lm/W) 2 | On / Off 1 | White 1 |
| | | 23W (1.420mm) 4 | 3.000K (105 lm/W) 3 | Dali 2 | Black 2 |
| | | 26W (1.720mm) 5 | 4.000K (111 lm/W) 4 | Push 3 | |
| | | 30W (1.970mm) 6 | 5.000K (114 lm/W) 5 | Casambi 5 | |
| | | | RGB-W (172 lm/W) 8 | Tuya 7 | |
| | | | CCT (100 lm/W) 9 | | |

Code: **1** **5** [] [] [] [] []



*Create your code according to your preferences. RGB-W and CCT only works with driver 5 and 7.



New

Dau E

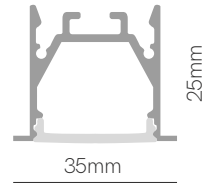
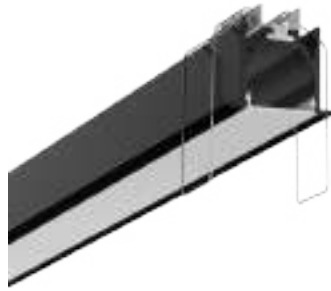

22mm x L



*Finished luminaire. Includes power supply, spring clips, power cable and end caps.

Technical Information

| | |
|--------------|-----------------------------|
| Version | Dau E |
| Power | 18W / 23W / 26W / 30W |
| Installation | Pendant |
| Material | Aluminium |
| Finishes | White (9003) / Black (9005) |

| Code | Diffuser (Angle) | Power (Size) | CCT (lm/W) | Driver | Colour |
|---------------|----------------------|------------------------|----------------------------|-------------------|----------------|
| Code 1 | Opal (110°) 6 | 18W (1.170mm) 3 | 2.700K (100 lm/W) 2 | On / Off 1 | White 1 |
| | | 23W (1.420mm) 4 | 3.000K (105 lm/W) 3 | Dali 2 | Black 2 |
| | | 26W (1.720mm) 5 | 4.000K (111 lm/W) 4 | Push 3 | |
| | | 30W (1.970mm) 6 | 5.000K (114 lm/W) 5 | Casambi 5 | |
| | | | RGB-W (172 lm/W) 8 | Tuya 7 | |
| | | | CCT (100 lm/W) 9 | | |

Code: **1** **6** [] [] [] [] []



*Create your code according to your preferences. RGB-W and CCT only works with driver 5 and 7.



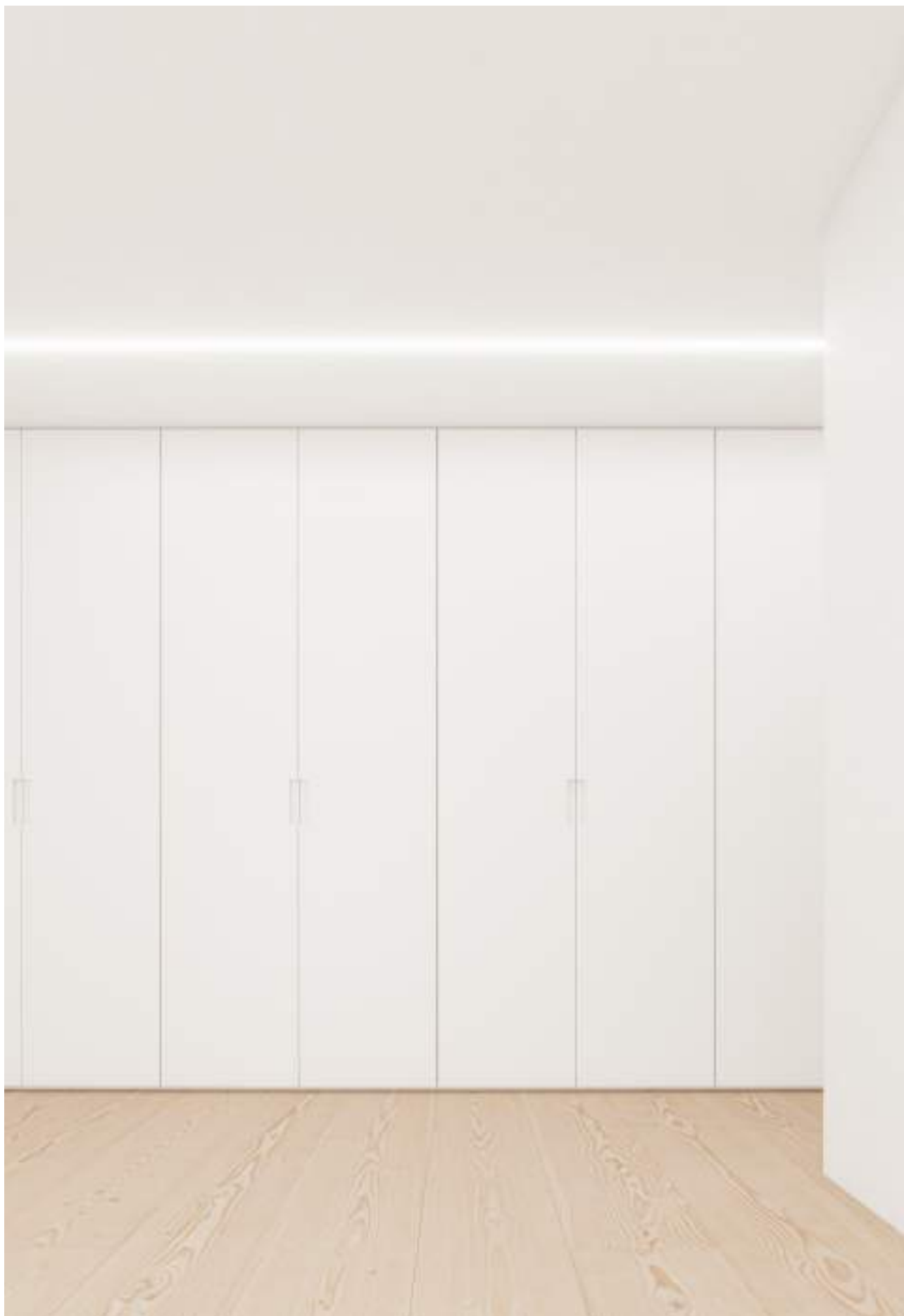



Zero direct

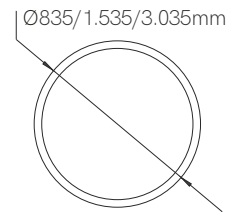
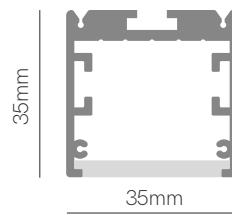

*Finished luminaire. Includes power supply, suspension kit, power cable and end caps.

Technical Information

| | |
|--------------|-----------------------------|
| Version | Zero direct |
| Power | 43W / 81W / 162W |
| Installation | Pendant |
| Material | Aluminium |
| Finishes | White (9003) / Black (9005) |

Equipment

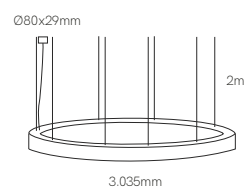
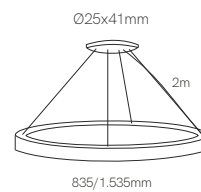

| Code | Diffuser | Power (Size) | CCT (lm/W) | Driver | Colour |
|---------------|---------------|-------------------------|---------------------------|-------------------|-----------------|
| Code 1 | Opal 7 | 43W (835mm) 2 | 2.700K (51 lm/W) 2 | On / Off 1 | White 1 |
| | | 81W (1535mm) 8 | 3.000K (51 lm/W) 3 | Dali 2 | Black 2 |
| | | 162W (3.035mm) 9 | 4.000K (53 lm/W) 4 | Push 3 | Gold 4 |
| | | | CCT (70 lm/W) 9 | Casambi 5 | Silver 5 |
| | | | | Tuya 7 | |

Code: **1** **7** ■ ■ ■ ■ ■

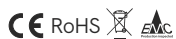

ⓘ On demand.

*Create your code according to your preferences. CCT only works with driver 5 and 7.



Zero Design

Zero 45°

| Code | Diffuser | Power (Size) | CCT (Lm/W) | Voltage | Colour |
|---------------|---------------|------------------------|----------------------------|----------------|---|
| Code Z | Opal 1 | 7W (800mm) 1 | 2.700K (155 Lm/w) 2 | 24VDC 0 | <input type="checkbox"/> White 1 |
| | | 12W (1.500mm) 4 | 3.000K (160 Lm/w) 3 | | <input type="checkbox"/> Black 2 |
| | | 24W (3.000mm) 7 | 4.000K (170 Lm/w) 4 | | <input checked="" type="radio"/> <input type="checkbox"/> Gold 4 |
| | | | CCT (130 Lm/w) 9 | | <input checked="" type="radio"/> <input type="checkbox"/> Silver 5 |

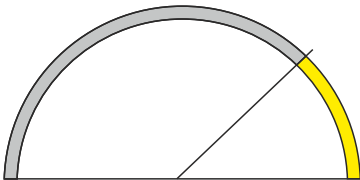

800 - 1.500 - 3.000mm

Code: **Z 1** **0**

Zero 90°

| Code | Diffuser | Power (Size) | CCT (Lm/W) | Voltage | Colour |
|---------------|---------------|------------------------|----------------------------|----------------|---|
| Code Z | Opal 1 | 14W (800mm) 2 | 2.700K (155 Lm/w) 2 | 24VDC 0 | <input type="checkbox"/> White 1 |
| | | 24W (1.500mm) 5 | 3.000K (160 Lm/w) 3 | | <input type="checkbox"/> Black 2 |
| | | | 4.000K (170 Lm/w) 4 | | <input checked="" type="radio"/> <input type="checkbox"/> Gold 4 |
| | | | CCT (130 Lm/w) 9 | | <input checked="" type="radio"/> <input type="checkbox"/> Silver 5 |

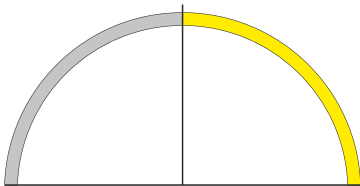

800 - 1.500mm

Code: **Z 1** **0**

Zero 90°

| Code | Diffuser | Power (Size) | CCT (Lm/W) | Voltage | Colour |
|---------------|---------------|-------------------------------|----------------------------|----------------|---|
| Code Z | Opal 1 | 24W-Extern (1.500mm) 3 | 2.700K (155 Lm/w) 2 | 24VDC 0 | <input type="checkbox"/> White 1 |
| | | 22W-Intern (1.500mm) 6 | 3.000K (160 Lm/w) 3 | | <input type="checkbox"/> Black 2 |
| | | | 4.000K (170 Lm/w) 4 | | <input checked="" type="radio"/> <input type="checkbox"/> Gold 4 |
| | | | CCT (130 Lm/w) 9 | | <input checked="" type="radio"/> <input type="checkbox"/> Silver 5 |

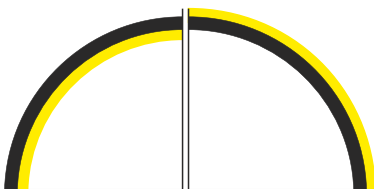

1.500mm

Code: **Z 1** **0**

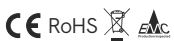

On demand.

*Create your luminaire according to your preferences.



Zero 180°

| Code | Diffuser | Power (Size) | CCT (Lm/W) | Voltage | Colour |
|---------------|---------------|------------------------|----------------------------|----------------|---|
| Code Z | Opal 1 | 24W (800mm) 8 | 2.700K (155 Lm/w) 2 | 24VDC 0 | <input type="checkbox"/> White 1 |
| | | 48W (1.500mm) 9 | 3.000K (160 Lm/w) 3 | | <input type="checkbox"/> Black 2 |
| | | | 4.000K (170 Lm/w) 4 | | <input checked="" type="radio"/> <input type="checkbox"/> Gold 4 |
| | | | CCT (130 Lm/w) 9 | | <input checked="" type="radio"/> <input type="checkbox"/> Silver 5 |

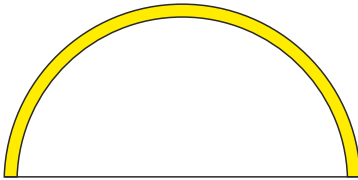

800 - 1.500mm

Code: **Z 1** **0**

Zero line

| Code | Diffuser | Power (Size) | CCT (Lm/W) | Voltage | Colour |
|---------------|---------------|------------------------|----------------------------|----------------|---|
| Code Z | Opal 1 | 50W (2.500mm) 0 | 2.700K (155 Lm/w) 2 | 24VDC 0 | <input type="checkbox"/> White 1 |
| | | | 3.000K (160 Lm/w) 3 | | <input type="checkbox"/> Black 2 |
| | | | 4.000K (170 Lm/w) 4 | | <input checked="" type="radio"/> <input type="checkbox"/> Gold 4 |
| | | | CCT (130 Lm/w) 9 | | <input checked="" type="radio"/> <input type="checkbox"/> Silver 5 |



2.500mm



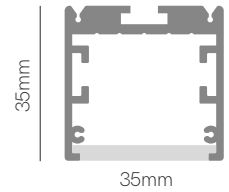

Code: **Z 1** **0**



On demand.

*Create your luminaire according to your preferences. Accessories on page 166-171.

Accessories

- 
End Cap
 40631
 40632
 40634
 40635
- 
Suspension Kit
Metallic
 40420 (2m)
- 
Ceiling suspension
 40430
- 
Kit Joint
Metallic
 40495

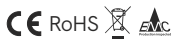

5 YEARS WARRANTY |
 50.000 HOURS |
 IP 20 |
 CRI ≥80 |
 160 LED/m |
  |
 24 VDC |
  |
  |
 





Zero dual

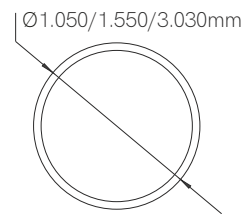
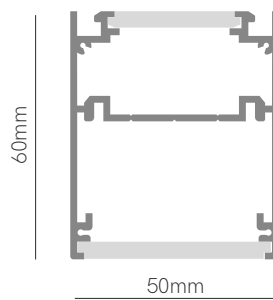

*Finished luminaire. Includes power supply, suspension kit, power cable and end caps.

Technical Information

| | |
|--------------|-----------------------------|
| Version | Zero dual |
| Power | 107W / 162W / 325W |
| Installation | Pendant |
| Material | Aluminium |
| Finishes | White (9003) / Black (9005) |

Equipment

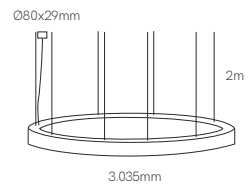
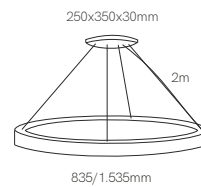

| Code | Diffuser | Power (Size) | CCT (lm/W) | Driver | Colour |
|---------------|---------------|-------------------------|----------------------------------|-------------------|----------------|
| Code 1 | Opal 8 | 107W (1.050mm) 3 | 3.000K (51 lm/W) 3 | On / Off 1 | White 1 |
| | | 162W (1.550mm) 8 | 4.000K (53 lm/W) 4 | Dali 2 | Black 2 |
| | | 325W (3.050mm) 9 | | Push 3 | |
| | | | | Casambi 5 | |
| | | | | Tuya 7 | |

Code: **1 8** ■ ■ ■ ■ ■

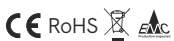

*Create your code according to your preferences.





New

Zero in

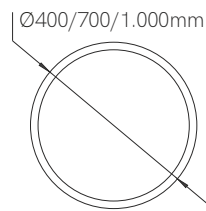
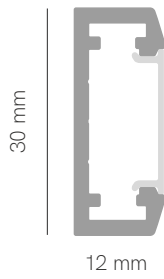

*Finished luminaire. Includes power supply, suspension kit, power cable and end caps.

Technical Information

| | |
|--------------|-----------------------------|
| Version | Zero in |
| Power | 26W / 44W / 63W |
| Installation | Pendant |
| Material | Aluminium |
| Finishes | White (9003) / Black (9005) |

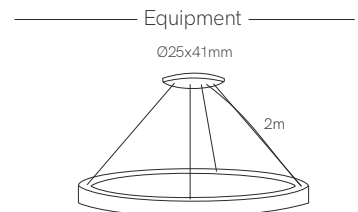

| Code | Diffuser | Power (Size) | CCT (Lm/W) | Driver | Colour |
|------|---------------|------------------------|----------------------------|-------------------|-----------------|
| Code | 1 Opal | 2 26W (400mm) | 2 2.700K (100 lm/W) | On / Off 1 | White 1 |
| | | 4 44W (700mm) | 3 3.000K (105 lm/W) | Dali 2 | Black 2 |
| | | 6 63W (1.000mm) | 4 4.000K (111 lm/W) | Push 3 | Gold 4 |
| | | | 8 RGB-W (172 lm/W) | Casambi 5 | Silver 5 |
| | | | 9 CCT (100 lm/W) | Tuya 7 | |

Code: **1** **2** [] [] [] [] []

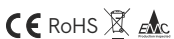

Ⓢ On demand.

*Create your code according to your preferences. RGB-W and CCT only works with driver 5 and 7.





New

Zero out

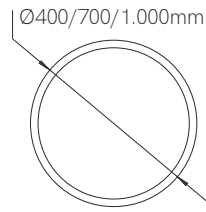
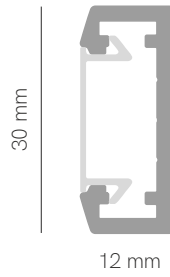

*Finished luminaire. Includes power supply, suspension kit, power cable and end caps.

Technical Information

| | |
|--------------|-----------------------------|
| Version | Zero out |
| Power | 26W / 44W / 63W |
| Installation | Pendant |
| Material | Aluminium |
| Finishes | White (9003) / Black (9005) |

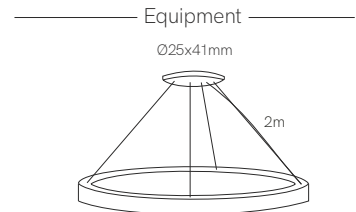

| Code | Diffuser | Power (Size) | CCT (Lm/W) | Driver | Colour | | | | | | |
|------|----------|---------------|------------|-------------------|----------|-------------------|----------|----------|----------|---------|----------|
| Code | 1 | Opal | 4 | 26W (400mm) | 2 | 2.700K (100 lm/W) | 2 | On / Off | 1 | □ White | 1 |
| | | 44W (700mm) | 4 | 3.000K (105 lm/W) | 3 | Dali | 2 | ■ Black | 2 | | |
| | | 63W (1.000mm) | 6 | 4.000K (111 lm/W) | 4 | Push | 3 | ⊙ Gold | 4 | | |
| | | | | RGB-W (172 lm/W) | 8 | Casambi | 5 | ⊙ Silver | 5 | | |
| | | | | CCT (100 lm/W) | 9 | Tuya | 7 | | | | |

Code: **1** **4** [] [] [] [] []



⊙ On demand.

*Create your code according to your preferences. RGB-W and CCT only works with driver 5 and 7.







New

Tubi

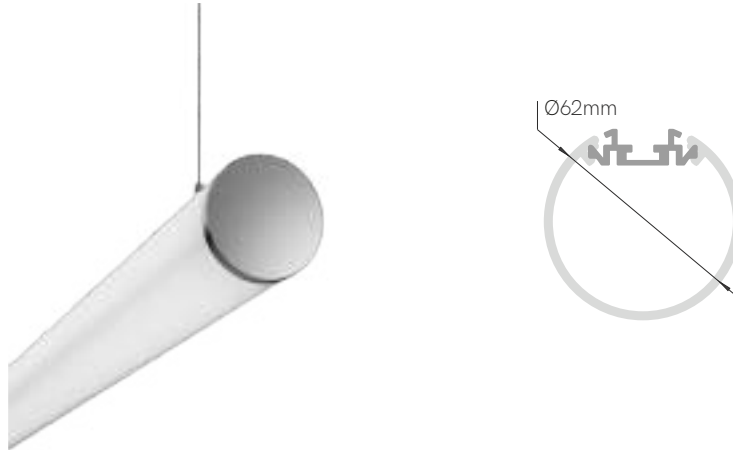

*Finished luminaire. Includes suspension kit, power cable and end caps (aluminium).

Technical Information

| | |
|--------------|-----------------------------|
| Version | Tubi |
| Power | 35W / 44W / 53W / 62W |
| Installation | Pendant |
| Material | Aluminium |
| Finishes | White (9003) / Black (9005) |

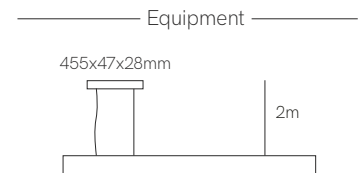

| Code | Diffuser (Angle) | Power (Size) | CCT (lm/W) | Driver | Colour |
|---------------|----------------------|------------------------|----------------------------|-------------------|----------------|
| Code 7 | Opal (270°) 1 | 35W (1.130mm) 3 | 2.700K (100 lm/W) 2 | On / Off 1 | White 1 |
| | | 44W (1.410mm) 4 | 3.000K (105 lm/W) 3 | Dali 2 | Black 2 |
| | | 53W (1.690mm) 5 | 4.000K (111 lm/W) 4 | Push 3 | |
| | | 62W (1.970mm) 6 | 5.000K (114 lm/W) 5 | Casambi 5 | |
| | | | RGB-W (172 lm/W) 8 | Tuya 7 | |
| | | | CCT (100 lm/W) 9 | | |

Code: **7** **1** [] [] [] [] []



*Create your code according to your preferences. RGB-W and CCT only works with driver 5 and 7.





New

Filter

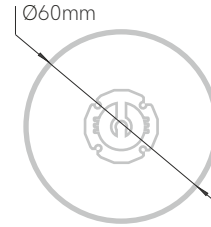

*Finished luminaire. Includes suspension kit, power cable and end caps.

Technical Information

| | |
|--------------|-----------------------------|
| Version | Filter |
| Power | 32W / 48W / 64W / 80W |
| Installation | Pendant |
| Material | Aluminium |
| Finishes | White (9003) / Black (9005) |

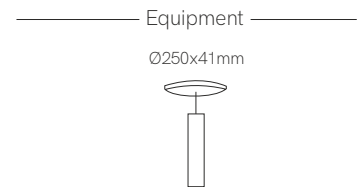

| Code | Diffuser (Angle) | Power (Size) | CCT (Lm/W) | Driver | Colour |
|---------------|----------------------|------------------------|----------------------------|-------------------|----------------|
| Code 3 | Opal (360°) 7 | 32W (800mm) 3 | 2.700K (100 lm/W) 2 | On / Off 1 | White 1 |
| | | 48W (1.200mm) 5 | 3.000K (105 lm/W) 3 | Dali 2 | Black 2 |
| | | 64W (1.600mm) 7 | 4.000K (111 lm/W) 4 | Push 3 | |
| | | 80W (2.000mm) 9 | RGB (58 lm/W) 7 | Casambi 5 | |
| | | | | Tuya 7 | |

Code: **3** **7** [] [] [] [] []

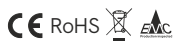

*Create your code according to your preferences. RGB only works with driver 5 and 7.



New

Grip

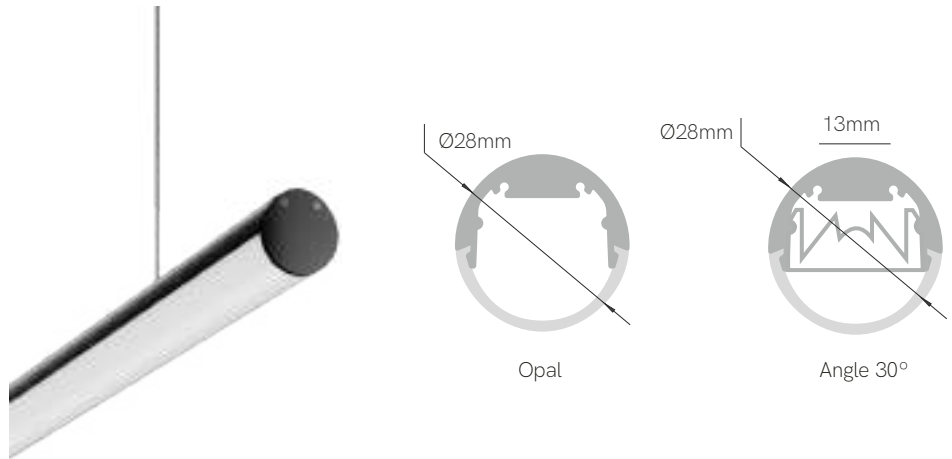

*Finished luminaire. Includes suspension kit, power cable and end caps.

Technical Information

| | |
|--------------|-----------------------|
| Version | Grip |
| Power | 26W / 33W / 39W / 46W |
| Installation | Pendant |
| Material | Aluminium |
| Finishes | Black (9005) |

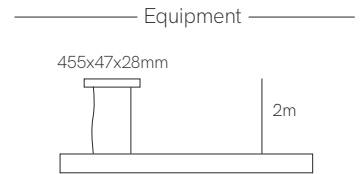

| Code | Diffuser (Angle) | Power (Size) | CCT (Lm/W) | Driver | Colour |
|---------------|------------------|------------------------|---------------------------------|-------------------|----------------|
| Code 2 | Opal 4 | 26W (1.130mm) 3 | 2.700K (97 lm/W) 2 | On / Off 1 | Black 2 |
| | 30° 8 | 33W (1.410mm) 4 | 3.000K (103 lm/W) 3 | Dali 2 | |
| | | 39W (1.690mm) 5 | 4.000K (108 lm/W) 4 | Push 3 | |
| | | 46W (1.970mm) 6 | RGB (172 lm/W) 8 | Casambi 5 | |
| | | | 2.700-6.000K (90 lm/W) 9 | Tuya 7 | |

Code: 2 ■ ■ ■ ■ ■ 2

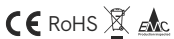

*Create your code according to your preferences.

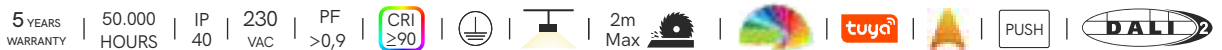

New

Square

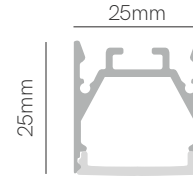

*Finished luminaire. Includes suspension kit, power cable and end caps.

Technical Information

| | |
|--------------|-----------------------------|
| Version | Square |
| Power | 43W / 62W |
| Installation | Pendant |
| Material | Aluminium |
| Finishes | White (9003) / Black (9005) |

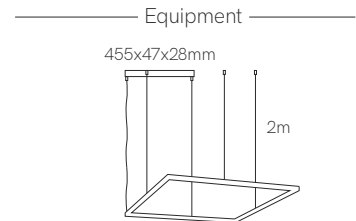

| Code | Diffuser (Angle) | Power (Size) | CCT (Lm/W) | Driver | Colour |
|---------------|----------------------|----------------------------|----------------------------|-------------------|-----------------|
| Code 3 | Opal (110°) 3 | 43W (530x530mm) 4 | 2.700K (100 lm/W) 2 | On / Off 1 | White 1 |
| | | 62W (1.030x530mm) 8 | 3.000K (105 lm/W) 3 | Push 3 | Black 2 |
| | | | 4.000K (111 lm/W) 4 | Casambi 5 | Gold 4 |
| | | | RGB-W (172 lm/W) 8 | Tuya 7 | Silver 5 |
| | | | CCT (100 lm/W) 9 | | |

Code: **3 3** [] [] [] [] []

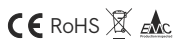

ⓘ On demand.

*Create your code according to your preferences. RGB-W and CCT only works with driver 5 and 7.





Dental Clinic Eva Flores, El Prat de Llobregat (Spain). Design: Meumstudio.

New

Flash



*Finished luminaire. Includes spring clips and end caps.

Technical Information

| | |
|--------------|---|
| Version | Flash |
| Power | 16W / 27W / 35W / 46W / 55W |
| Installation | Wall |
| Material | Aluminium |
| Finishes | White (9003) / Black (9005) / Aluminium |

| Code | Diffuser | Power (Size) | CCT (lm/W) | Driver | Colour |
|---------------|---------------|------------------------|-----------------------------------|-------------------|--|
| Code 3 | Opal 9 | 16W (520mm) 1 | 2.700K (100 lm/W) 2 | On / Off 1 | <input type="checkbox"/> White 1 |
| | | 27W (895mm) 2 | 3.000K (105 lm/W) 3 | | <input checked="" type="checkbox"/> Black 2 |
| | | 35W (1.145mm) 3 | 4.000K (110 lm/W) 4 | | <input type="checkbox"/> Aluminium 9 |
| | | 46W (1.520mm) 5 | 6.000K (110 lm/W) 6 | | |
| | | 55W (1.825mm) 6 | | | |

Code: **3** **9** **1**

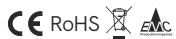

*Create your code according to your preferences.



New

Triton

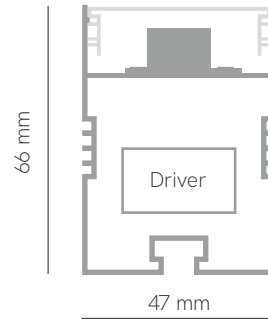

*Finished luminaire. Includes power supply, clip rotable, 2mts power cable and end caps.

Technical Information

| | |
|--------------|-----------------|
| Version | Triton |
| Power | 27W / 54W / 81W |
| Installation | Surface |
| Material | Aluminium |
| Finishes | Black (9005) |



| Code | Diffuser | Power (Size) | CCT (lm/W) | Driver | Colour |
|---------------|-------------------------------|------------------------|----------------------------|-------------------|----------------|
| Code 4 | Asymmetric (15°/35°) 9 | 27W (420mm) 1 | 2.700K (130 lm/W) 2 | On / Off 1 | Black 2 |
| | | 54W (820mm) 2 | 3.000K (130 lm/W) 3 | Dali 2 | |
| | | 81W (1.220mm) 3 | 4.000K (130 lm/W) 4 | | |

Code: **4 9** **2**

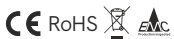

*Create your code according to your preferences.



New

Triton down

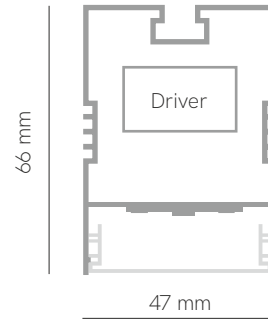

*Finished luminaire. Includes power supply, clip rotatable, 2mts power cable and end caps.

Technical Information

| | |
|--------------|------------------------------|
| Version | Triton down |
| Power | 46W / 57W / 69W / 80W / 103W |
| Installation | Surface / Pendant |
| Material | Aluminium |
| Finishes | White (9003) / Black (9005) |

| Code | Diffuser | Power (Size) | CCT (lm/W) | Driver | Colour | | | | | | |
|------|----------|--------------|------------|----------------|----------|-------------------|----------|----------|----------|-------|----------|
| Code | 4 | Opal | 6 | 46W (1.130mm) | 3 | 2.700K (112 lm/W) | 2 | On / Off | 1 | White | 1 |
| | | | | 57W (1.410mm) | 4 | 3.000K (128 lm/W) | 3 | Dali | 2 | Black | 2 |
| | | | | 69W (1.690mm) | 5 | 4.000K (136 lm/W) | 4 | | | | |
| | | | | 80W (1.970mm) | 6 | 5.500K (136 lm/W) | 5 | | | | |
| | | | | 103W (2.530mm) | 7 | | | | | | |

Code: **4** **6**

*Create your code according to your preferences.

Accessories

- 
 Wall bracket
 40531
 40532
- 
 Ceiling suspension
 40510
- 
 Suspension Kit
 40520 (2m)

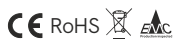

5 YEARS WARRANTY |
 50.000 HOURS |
 IP 65 |
 230 VAC |
 PF >0,9 |
 CRI ≥95 |
  |
  |
  |
  |
  |
 



















Profiles

| | |
|-------------|-------------|
| 100. Box 18 | 112. Box 23 |
| 101. Box 17 | 113. Box 53 |
| 102. Box 16 | 114. Box 21 |
| 103. Box 15 | 115. Box 27 |
| 104. Box 19 | 116. Box 22 |
| 105. Box 10 | 117. Box 29 |
| 106. Box 35 | 118. Box 30 |
| 107. Box 38 | 119. Box 33 |
| 108. Box 12 | 120. Box 39 |
| 109. Box 11 | 121. Box 28 |
| 110. Box 13 | 122. Box 37 |
| 111. Box 14 | |

| Model | Page | Section Size | Max Power | IP |
|------------|------|--------------|------------|----------|
| BOX 18 | 100 | 17,3x14,5mm | 20W MAX | 20 IP |
| BOX 17 | 101 | 25x14,5mm | 20W MAX | 20 IP |
| BOX 16 | 102 | 17,3x7mm | 20W MAX | 20 IP |
| BOX 15 | 103 | 25x7mm | 20W MAX | 20 IP |
| BOX 19 | 104 | 25x25mm | 25W MAX | 20 IP |
| BOX 10 | 105 | 35x25mm | 25W MAX | 20 IP |
| BOX 35 | 106 | 35x35mm | 40W MAX | 20 IP |
| BOX 38 | 107 | 50x35mm | 40W MAX | 20 IP |
| BOX 12 | 108 | 10x15mm | 15W MAX | 20 IP |
| BOX 11 | 109 | 16x15mm | 15W MAX | 20 IP |
| BOX 13 | 110 | 17,9x5,7mm | 15W MAX | 20 IP |
| BOX 14 | 111 | 16x16mm | 15W MAX | 20 IP |
| BOX 23 | 112 | 23x10,8 mm | 25W MAX | 20 IP |
| New BOX 53 | 113 | 30,5x10,8mm | 25W MAX | 20 IP |
| BOX 21 | 114 | 26,7x76,2mm | 15W MAX | 20 IP |

| Installation | Standard finishes | Standard Size |
|--|-------------------|---------------|
|  Surface | Alum. Black White | 2m |
|  Recessed | Alum. Black White | 2m |
|  Surface | Alum. Black White | 2m |
|  Recessed | Alum. Black White | 2m |
|  Surface | Alum. Black White | 2m |
|  Recessed | Alum. Black White | 2m |
|  Surface | Alum. Black White | 2m |
|  Recessed | Alum. Black White | 2m |
|  Surface | Alum. | 2m |
|  Recessed | Alum. | 2m |
|  Surface | Alum. | 2m |
|  Surface | Alum. | 2m |
|  Surface | Alum. Black White | 2m |
|  Recessed | Alum. Black White | 2m |
|  Recessed | Alum. White | 2m |

| Model | Page | Section Size | Max Power | IP |
|---------------|------|--------------|------------|----------|
| BOX 27 | 115 | 17,7x43,5mm | 15W MAX | 20 IP |
| BOX 22 | 116 | 17,8x48,6mm | 15W MAX | 20 IP |
| BOX 29 | 117 | 21x26mm | 20W MAX | 55 IP |
| BOX 30 | 118 | 12/20x2mm | 20W MAX | 20 IP |
| New BOX 33 | 119 | 29,4x50mm | 20W MAX | 20 IP |
| New BOX 39 | 120 | Ø28mm | 25W MAX | 20 IP |
| New BOX 28 | 121 | 18x22,2mm | 40W MAX | 20 IP |
| New BOX 37 | 122 | 79x32mm | 40W MAX | 40 IP |

| Installation | Standard finishes | Standard Size |
|--|---|---------------|
|  Surface |    | 2m |
|  Surface |   | 2m |
|  Surface |  | 2m |
|  Surface |  | 2m |
|  Surface |    | 2m |
|  Surface |  | 2m |
|  Surface |  | 2m |
|  Trimless |  | 2m |



Surface

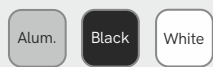

Black

White

2m



Surface



Black

2m



Surface



2m



Surface



2m



Surface

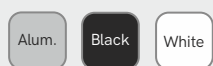

Black

White

2m



Surface



2m



Surface



2m



Trimless



2m

Box 18

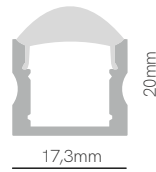
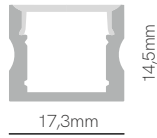

*Useful area: 12x10mm.

Technical Information

| | |
|--------------|---|
| Version | Box 18 |
| Max. power | 20W |
| Installation | Surface |
| Material | Aluminium |
| Finishes | White / Black / Aluminium |
| Code | 18121 <input type="checkbox"/> |
| | 18122 <input checked="" type="checkbox"/> |
| | 18119 <input type="checkbox"/> |

Accessories

| | | | | | | | | | | | |
|--|---|---|---|--|--|---|--|--|--|---|--|
| | | | | | | | | | | | |
| Diffuser PC Transp. 90% <input type="checkbox"/> 20450 | Diffuser PC Opal 70% <input type="checkbox"/> 20440 | Diffuser PC Black 50% <input checked="" type="checkbox"/> 20472 | Diffuser Silicone Opal 60% <input type="checkbox"/> 20469 <input type="checkbox"/> 20469-15 | End Cap <input type="checkbox"/> 18631 <input checked="" type="checkbox"/> 18632 <input type="checkbox"/> 18633 | End Cap <input type="checkbox"/> 18621 <input checked="" type="checkbox"/> 18622 <input type="checkbox"/> 18623 | Diffuser PC Optic 60° Transp. 90% <input type="checkbox"/> 20430 | End Cap 60° <input type="checkbox"/> 18651 <input checked="" type="checkbox"/> 18652 <input type="checkbox"/> 18653 | End Cap 60° <input type="checkbox"/> 18661 <input checked="" type="checkbox"/> 18662 <input type="checkbox"/> 18663 | Clip Metallic <input type="checkbox"/> 20330 | Clip Rotable Metallic <input type="checkbox"/> 20350 | Clip PC <input type="checkbox"/> 20380 <input checked="" type="checkbox"/> 20382 |



3 YEARS WARRANTY | IP 20 | 2m Max | | AL 6063 | p.172

Box 17

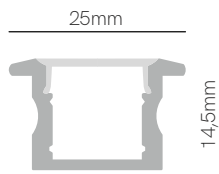

18mm x L



*Useful area: 12x10mm.

Technical Information

| | |
|--------------|---|
| Version | Box 17 |
| Max. power | 20W |
| Installation | Recessed |
| Material | Aluminium |
| Finishes | White / Black / Aluminium |
| Code | 17121 <input type="checkbox"/> |
| | 17122 <input checked="" type="checkbox"/> |
| | 17119 <input type="checkbox"/> |

Accessories

| | | | | | |
|--------------------------------|--------------------------------|---|---|---|---|
| | | | | | |
| Diffuser PC Transp. 90% | Diffuser PC Opal 70% | Diffuser PC Black 50% | Diffuser Silicone Opal 60% | End Cap | End Cap |
| <input type="checkbox"/> 20450 | <input type="checkbox"/> 20440 | <input checked="" type="checkbox"/> 20472 | <input type="checkbox"/> 20469 <input type="checkbox"/> 20469-15 | <input type="checkbox"/> 17631 <input checked="" type="checkbox"/> 17632 <input type="checkbox"/> 17633 | <input type="checkbox"/> 17621 <input checked="" type="checkbox"/> 17622 <input type="checkbox"/> 17623 |



Box 16

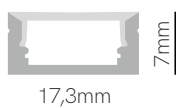

*Useful area: 12x5mm.

Technical Information

| | |
|--------------|---|
| Version | Box 16 |
| Max. power | 20W |
| Installation | Surface |
| Material | Aluminium |
| Finishes | White / Black / Aluminium |
| Code | 16121 <input type="checkbox"/> 16122 <input checked="" type="checkbox"/> 16119 <input type="checkbox"/> |

Accessories



Diffuser PC
Transp. 90%
 20450



Diffuser PC
Opal 70%
 20440



Diffuser PC
Black 50%
 20472



Diffuser
Silicone
Opal 60%
 20469
 20469-15



End Cap
 16631
 16632
 16633



End Cap
 16621
 16622
 16623



Clip
Metallic
 20330



Clip
Rotable
Metallic
 20350



Clip PC
 20380
 20382



Box 15

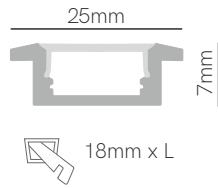

*Useful area: 12x5mm.

Technical Information

| | |
|--------------|---|
| Version | Box 15 |
| Max. power | 20W |
| Installation | Recessed |
| Material | Aluminium |
| Finishes | White / Black / Aluminium |
| Code | 15121 <input type="checkbox"/> |
| | 15122 <input checked="" type="checkbox"/> |
| | 15119 <input type="checkbox"/> |

Accessories

| | | | | | |
|--------------------------------|--------------------------------|---|---|---|---|
| | | | | | |
| Diffuser PC Transp. 90% | Diffuser PC Opal 70% | Diffuser PC Black 50% | Diffuser Silicone Opal 60% | End Cap | End Cap |
| <input type="checkbox"/> 20450 | <input type="checkbox"/> 20440 | <input checked="" type="checkbox"/> 20472 | <input type="checkbox"/> 20469 <input type="checkbox"/> 20469-15 | <input type="checkbox"/> 15631 <input checked="" type="checkbox"/> 15632 <input type="checkbox"/> 15633 | <input type="checkbox"/> 15621 <input checked="" type="checkbox"/> 15622 <input type="checkbox"/> 15623 |

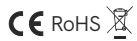

Box 19

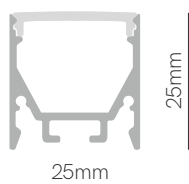

*Useful area: 12x17,7mm.

Technical Information

| | |
|--------------|---|
| Version | Box 19 |
| Max. power | 25W |
| Installation | Surface |
| Material | Aluminium |
| Finishes | White / Black / Aluminium |
| Code | 19121 <input type="checkbox"/> 19122 <input checked="" type="checkbox"/> 19119 <input type="checkbox"/> |

Accessories



| | | | | | | | | | | | |
|---|---|--|--|--|---|---|--|--|---|--|--|
| Diffuser PC Opal 70% <input type="checkbox"/> 20490 | Diffuser PC Black 50% <input checked="" type="checkbox"/> 20502 | Diffuser Continuous <input type="checkbox"/> 20997 | End Cap <input type="checkbox"/> 19621 <input checked="" type="checkbox"/> 19622 <input type="checkbox"/> 19623 | Clip Metallic <input type="checkbox"/> 19330 | Joint 90° Metallic <input type="checkbox"/> 20510 | Joint 90° Metallic <input type="checkbox"/> 20540 | Joint 120° Metallic <input type="checkbox"/> 20530 | Joint 180° Metallic <input type="checkbox"/> 20520 | Suspension Kit Metallic <input type="checkbox"/> 20720 (2m) | Base 455x47x28mm <input type="checkbox"/> 35331 <input type="checkbox"/> 35361 <input type="checkbox"/> 35311 | <input checked="" type="checkbox"/> 35332 (30W/24V) <input checked="" type="checkbox"/> 35362 (60W/24V) <input checked="" type="checkbox"/> 35312 (100W/24V) |
|---|---|--|--|--|---|---|--|--|---|--|--|

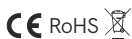

Box 10

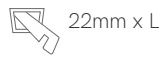
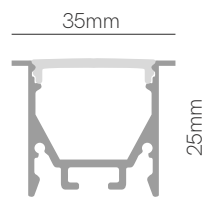

*Useful area: 12x17,7mm.

Technical Information

| | |
|--------------|---|
| Version | Box 10 |
| Max. power | 25W |
| Installation | Recessed |
| Material | Aluminium |
| Finishes | White / Black / Aluminium |
| Code | 10121 <input type="checkbox"/> 10122 <input checked="" type="checkbox"/> 10119 <input type="checkbox"/> |

Accessories

| | | | | | | | | |
|---|---|--|--|--|--|---|---|---|
| | | | | | | | | |
| Diffuser PC Opal 70% <input type="checkbox"/> 20490 | Diffuser PC Black 50% <input checked="" type="checkbox"/> 20502 | Diffuser Continuous <input type="checkbox"/> 20997 | End Cap <input type="checkbox"/> 10621 <input checked="" type="checkbox"/> 10622 <input type="checkbox"/> 10623 | Joint 90° Metallic <input checked="" type="checkbox"/> 20510 | Joint 90° Metallic <input checked="" type="checkbox"/> 20540 | Joint 120° Metallic <input checked="" type="checkbox"/> 20530 | Joint 180° Metallic <input checked="" type="checkbox"/> 20520 | Clip Metallic <input checked="" type="checkbox"/> 20710 |



Box 35

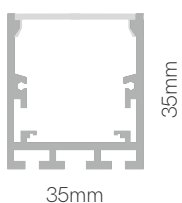

*Useful area: 23x20mm.

Technical Information

| | |
|--------------|---|
| Version | Box 35 |
| Max. power | 40W |
| Installation | Surface |
| Material | Aluminium |
| Finishes | White / Black / Aluminium |
| Code | 35121 <input type="checkbox"/> 35122 <input checked="" type="checkbox"/> 35119 <input type="checkbox"/> |

Accessories

| | | | | | | | | | |
|---|---|--|---|--|--|---|---|--|---|
| | | | | | | | | | |
| Diffuser PC Opal 70% <input type="checkbox"/> 20700 | Diffuser PC Black 50% <input checked="" type="checkbox"/> 20772 | End Cap <input type="checkbox"/> 35621 <input checked="" type="checkbox"/> 35622 <input type="checkbox"/> 35623 | Clip Metallic <input checked="" type="checkbox"/> 35330 | Joint 90° Metallic <input checked="" type="checkbox"/> 20510 | Joint 90° Metallic <input checked="" type="checkbox"/> 20540 | Joint 120° Metallic <input checked="" type="checkbox"/> 20530 | Joint 180° Metallic <input checked="" type="checkbox"/> 20520 | Suspension Kit Metallic <input checked="" type="checkbox"/> 20720 (2m) | Base 455x47x28mm <input type="checkbox"/> 35331 <input checked="" type="checkbox"/> 35332 (30W/24V) <input type="checkbox"/> 35361 <input checked="" type="checkbox"/> 35362 (60W/24V) <input type="checkbox"/> 35311 <input checked="" type="checkbox"/> 35312 (100W/24V) |

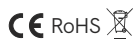

3 YEARS WARRANTY | IP 20 | | | 2m Max | | AL 6063 | p.172

Box 38

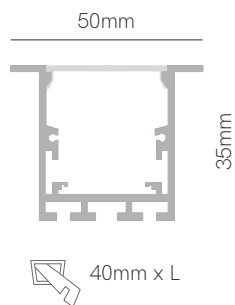

*Useful area: 23x20mm.

Technical Information

| | |
|--------------|---|
| Version | Box 38 |
| Max. power | 40W |
| Installation | Recessed |
| Material | Aluminium |
| Finishes | White / Black / Aluminium |
| Code | 38121 <input type="checkbox"/> |
| | 38122 <input checked="" type="checkbox"/> |
| | 38119 <input type="checkbox"/> |

Accessories

| | | | | | | | |
|---|---|--|---|---|--|--|--|
| | | | | | | | |
| Diffuser PC Opal 70% <input type="checkbox"/> 20700 | Diffuser PC Black 50% <input checked="" type="checkbox"/> 20772 | End Cap <input type="checkbox"/> 38621 <input checked="" type="checkbox"/> 38622 <input type="checkbox"/> 38623 | Joint 90° Metallic <input type="checkbox"/> 20510 | Joint 90° Metallic <input type="checkbox"/> 20540 | Joint 120° Metallic <input type="checkbox"/> 20530 | Joint 180° Metallic <input type="checkbox"/> 20520 | Clip Metallic <input type="checkbox"/> 20710 |

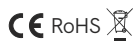

Box 12



*Useful area: 5x10mm.

Technical Information

| | |
|--------------|-----------|
| Version | Box 12 |
| Max. power | 15W |
| Installation | Surface |
| Material | Aluminium |
| Finishes | Aluminium |
| Code | 12119 |

Accessories



Diffuser PC
Opal 70%
 20480



End Cap
 12633



End Cap
 12623



Clip
Metallic
 20730

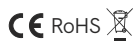

3 YEARS WARRANTY |
 IP 20 |
 2m Max |
 AL 6063 |
 p.172

Box 11

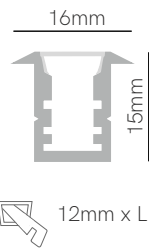

*Useful area: 5x10mm.

Technical Information

| | |
|--------------|--------------------------------|
| Version | Box 11 |
| Max. power | 15W |
| Installation | Recessed |
| Material | Aluminium |
| Finishes | Aluminium |
| Code | 11119 <input type="checkbox"/> |

Accessories



Diffuser PC
Opal 70%
 20480



End Cap
 11633



End Cap
 11623

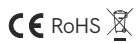

3 YEARS WARRANTY | IP 20 | | 2m Max | | AL 6063 | p.172

Box 13

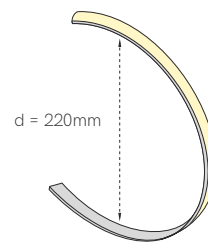
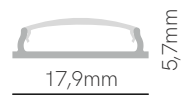

*Useful area: 12x3mm.

Technical Information

| | |
|--------------|-----------|
| Version | Box 13 |
| Max. power | 15W |
| Installation | Surface |
| Material | Aluminium |
| Finishes | Aluminium |
| Code | 13113 |

Accessories



Diffuser PC
Opal 70%
 13480



End Cap
 13633



End Cap
 13623



Clip
Metallic
 13330

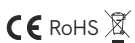

3 YEARS WARRANTY |
 IP 20 |
 2m Max |
 AL 6063 |
 p.172

Box 14

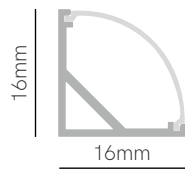

*Useful area: 10x5mm.

Technical Information

| | |
|--------------|--------------------------------|
| Version | Box 14 |
| Max. power | 15W |
| Installation | Surface |
| Material | Aluminium |
| Finishes | Aluminium |
| Code | 14119 <input type="checkbox"/> |

Accessories



Diffuser PC
Opal 70%
 14480



End Cap
 14633



End Cap
 14623



Clip
Metallic
 14330



Box 23

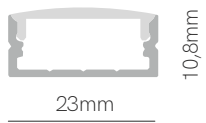

*Useful area: 20x6mm.

Technical Information

| | |
|--------------|---|
| Version | Box 23 |
| Max. power | 25W |
| Installation | Surface |
| Material | Aluminium |
| Finishes | White / Black / Aluminium |
| Code | 23121 <input type="checkbox"/> |
| | 23122 <input checked="" type="checkbox"/> |
| | 23119 <input type="checkbox"/> |

Accessories



Diffuser PC
Opal 70%
 23480



End Cap
 23631
 23632
 23633



End Cap
 23621
 23622
 23623



Clip PC
 23380

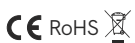

3 YEARS WARRANTY | IP 20 | | 2m Max | | AL 6063 | p.172

New

Box 53

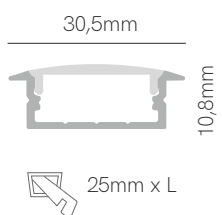

*Useful area: 20x6mm.

Technical Information

| | |
|--------------|---------------------------|
| Version | Box 53 |
| Max. power | 25W |
| Installation | Recessed |
| Material | Aluminium |
| Finishes | White / Black / Aluminium |

| | |
|------|---|
| Code | 53121 <input type="checkbox"/> |
| | 53122 <input checked="" type="checkbox"/> |
| | 53119 <input type="checkbox"/> |

Accessories



Diffuser PC
Opal 70%
 23480



End Cap
 53631
 53632
 53633



End Cap
 53621
 53622
 53623



3 YEARS WARRANTY | IP 20 | | 2m Max | | AL 6063 | p.172

Box 21

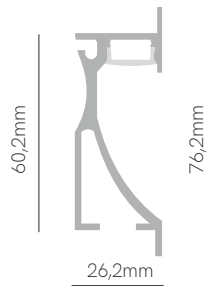

*Useful area: 12x3mm.

Technical Information

| | |
|--------------|--------------------------------|
| Version | Box 21 |
| Max. power | 15W |
| Installation | Recessed |
| Material | Aluminium |
| Finishes | White / Aluminium |
| Code | 21121 <input type="checkbox"/> |
| | 21119 <input type="checkbox"/> |

Accessories



Diffuser PC
Opal 70%
 20497



Diffuser
Silicone Opal 60%
 20469
 20469-15



End Cap
 21631
 21633



End Cap
 21621
 21623



3 YEARS WARRANTY | IP 20 | | 2m Max | | AL 6063 | p.172

Box 27



*Useful area: 12x3mm.

Technical Information

| | |
|--------------|---------------------------|
| Version | Box 27 |
| Max. power | 15W |
| Installation | Surface |
| Material | Aluminium |
| Finishes | White / Black / Aluminium |

| | |
|------|---|
| Code | 27121 <input type="checkbox"/> |
| | 27122 <input checked="" type="checkbox"/> |
| | 27119 <input type="checkbox"/> |

Accessories



Diffuser PC
Opal 70%
 20497



Diffuser
Silicone Opal 60%
 20469
 20469-15



End Cap
 27631
 27632
 27633



End Cap
 27621
 27622
 27623

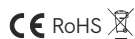

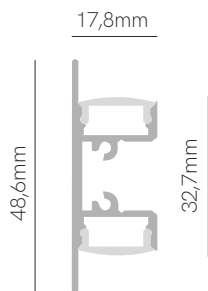

Box 22



*Useful area: 12x3mm.

Technical Information



| | |
|--------------|---|
| Version | Box 22 |
| Max. power | 15W |
| Installation | Surface |
| Material | Aluminium |
| Finishes | Black / Aluminium |
| Code | 22122  |
| | 22119  |

Accessories



Diffuser PC
Opal 70%
 20497



Diffuser
Silicone Opal 60%
 20469
 20469-15



End Cap
 22622
 22623



End Cap
 22632
 22633



Clip
Metallic
 22330

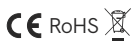

3 YEARS WARRANTY | IP 20 |  | 2m Max  |  | AL 6063 |  p.172

Box 29

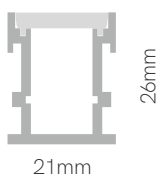

*Useful area: 12x18mm.

Technical Information

| | |
|--------------|---|
| Version | Box 29 |
| Max. power | 25W |
| Installation | Surface |
| Material | Aluminium |
| Finishes | Aluminium |
| Code | 29119  |

Accessories



Diffuser PC
Opal 70%
 29480

End Cap
 29623

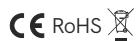

 3 YEARS WARRANTY |
  IP 55 |
  |
  IK10 |
  100kg |
  2m Max |
  |
  AL 6063 |
  p.172

Box 30 12mm

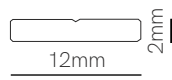

Box 30 20mm

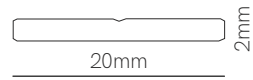

Technical Information

| | | |
|--------------|--------------------------------|--------------------------------|
| Version | Box 30 12mm | Box 30 20mm |
| Max. power | 20W | 40W |
| Installation | Surface | Surface |
| Material | Aluminium | Aluminium |
| Finishes | Aluminium | Aluminium |
| Code | 30129 <input type="checkbox"/> | 30209 <input type="checkbox"/> |



3 YEARS WARRANTY | IP 20 | | 2m Max | | AL 6063 | p.172

New

Box 33

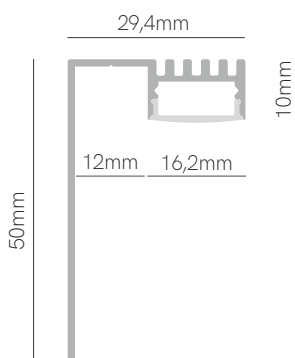

*Useful area: 12,6x6,3mm.

Technical Information

| | |
|--------------|---------------------------|
| Version | Box 33 |
| Max. power | 20W |
| Installation | Surface |
| Material | Aluminium |
| Finishes | White / Black / Aluminium |

| | |
|------|---|
| Code | 33121 <input type="checkbox"/> |
| | 33122 <input checked="" type="checkbox"/> |
| | 33119 <input type="checkbox"/> |

Accessories



Diffuser PC
Opal 70%
 33440

Diffuser
Silicone
Opal 60%
 20469
 20469-15

End Cap
 33621
 33622
 33623



New

Box 39

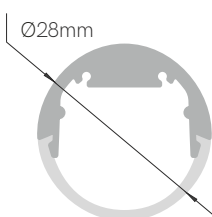

Opal

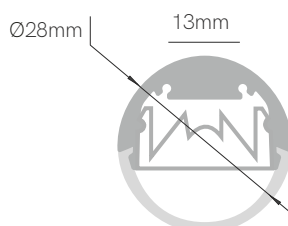

Angle 30°



*Useful area: 12x8mm.

Technical Information

| | |
|--------------|-----------|
| Version | Box 39 |
| Max. power | 25W |
| Installation | Surface |
| Material | Aluminium |
| Finishes | Black |
| Code | 39122 ■ |

Accessories



Diffuser PC
Opal 70%
■ 39440



Diffuser PC
Transp. 90%
■ 39450



Diffuser PC
Optic 30%
■ 39430



End Cap
■ 39622



Clip
Plastic
■ 25530



Suspension Kit
■ 25887 (2m)



Base 455x47x28mm
 ■ 35331 (30W/24V) ■ 35332 (30W/24V)
 ■ 35361 (60W/24V) ■ 35362 (60W/24V)
 ■ 35311 (100W/24V) ■ 35312 (100W/24V)



3 YEARS WARRANTY | IP 20 | | 2m Max | | AL 6063 | p.172

New

Box 28



*Useful area: 12x8mm.

Technical Information

| | |
|--------------|--------------------------------|
| Version | Box 28 |
| Max. power | 40W |
| Installation | Surface |
| Material | Aluminium |
| Finishes | Aluminium |
| Code | 28119 <input type="checkbox"/> |

Accessories



Diffuser PC
Optic 30%
 28430



End Cap
 28633



End Cap
 28623



Clip
Metallic
 28330



3 YEARS WARRANTY | IP 20 |  | 2m Max  |  | AL 6063 |  p.172

New

Box 37

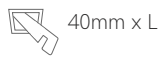
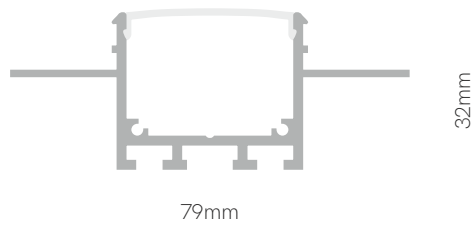

*Useful area: 23x20mm.

Technical Information

| | |
|--------------|--------------------------------|
| Version | Box 37 |
| Max. power | 40W |
| Installation | Trimless |
| Material | Aluminium |
| Finishes | White |
| Code | 37121 <input type="checkbox"/> |

Accessories



Diffuser PC
Opal 70%
 37480



End Cap
 37621



3 YEARS WARRANTY | IP 40 | | 2m Max | | AL 6063 | p.172























































Private Residence, Guadalajara (Spain). Design: Carlos Lozano.









LED Strips

| | |
|----------------|--------------|
| 131. Fine 84 | 146. Fine 36 |
| 133. Fine 69 | 147. Fine 42 |
| 134. Fine 51 | 148. Fine 50 |
| 135. Fine 49 | 149. Fine 46 |
| 136. Fine 31 | 151. Fine 43 |
| 137. Fine 44 | 152. Fine 47 |
| 139. Fine 41 | 153. Fine 66 |
| 141. Fine 61 | 155. Fine 45 |
| 142. Fine 32 N | 158. Fine 70 |
| 143. Fine 52 | 160. Fine 72 |
| 144. Fine 56 | 161. Fine 74 |
| 145. Fine 55 | 164. Fine 25 |

| Model | Page | Power | CCT | CRI |
|---------------|------|----------|-------------------------|-----------|
| FINE 84 | 131 | 4,8 W/m | 2700K 3000K 4000K 6000K | ≥90 CRI |
| FINE 69 | 133 | 9,6 W/m | 2700K 3000K 4000K 6000K | ≥90 CRI |
| New FINE 51 | 134 | 9,6 W/m | 2700K 3000K 4000K 6000K | ≥90 CRI |
| FINE 49 | 135 | 10 W/m | 2700K 3000K 4000K 6000K | ≥90 CRI |
| FINE 31 | 136 | 12 W/m | 2700K 3000K 4000K | ≥90 CRI |
| FINE 44 | 137 | 14,4 W/m | MEAT FISH FRUIT BREAD | 75/97 CRI |
| FINE 41 | 139 | 14,4 W/m | 2700K 3000K 4000K 6000K | ≥90 CRI |
| FINE 61 | 141 | 15 W/m | 2700K 3000K 4000K 6000K | ≥90 CRI |
| New FINE 32 N | 142 | 15 W/m | 2700K 3000K 4000K 6000K | ≥80 CRI |
| FINE 52 | 143 | 22 W/m | 2700K 3000K 4000K 6000K | ≥90 CRI |
| New FINE 56 | 144 | 22 W/m | 2700K 3000K 4000K CCT | ≥80 CRI |
| FINE 55 | 145 | 24 W/m | 2700K 3000K 4000K | ≥90 CRI |
| FINE 36 | 146 | 12 W/m | CCT | ≥90 CRI |
| New FINE 42 | 147 | 19,2 W/m | CCT | ≥90 CRI |
| FINE 50 | 148 | 9,6 W/m | RGB | — |

| Lumens | Density | Width | Voltage | IP20 | IP65 | IP67 |
|--------------|-----------|---------|-------------|---|---|---|
| 95-102 Lm/W | 70 LED/m | 10mm | 24 VDC |  |  | - |
| 95-102 Lm/W | 140 LED/m | 10mm | 24 VDC |  |  | - |
| 100 Lm/W | 120 LED/m | 10mm | 24 VDC |  | - |  |
| 71-77 Lm/W | 204 LED/m | 4mm | 24 VDC |  | - | - |
| 95-100 Lm/W | 512 LED/m | 10/14mm | 24 VDC |  | - |  |
| 80-95 Lm/W | 140 LED/m | 10mm | 24 VDC |  | - | - |
| 95-102 Lm/W | 140 LED/m | 10mm | 24 VDC |  |  | - |
| 110-125 Lm/W | 160 LED/m | 10mm | 24 VDC |  |  | - |
| 100-110 Lm/W | 112 LED/m | 14mm | 220/240 VDC | - |  | - |
| 97-112 Lm/W | 238 LED/m | 10/14mm | 24 VDC |  | - |  |
| 130-170 Lm/W | 160 LED/m | 15mm | 24 VDC |  | - | - |
| 80-86 Lm/W | 120 LED/m | 20mm | 24 VDC |  | - | - |
| 100 Lm/W | 140 LED/m | 10mm | 24 VDC |  | - | - |
| 90 Lm/W | 168 LED/m | 10mm | 24 VDC |  |  | - |
| 58 Lm/W | 120 LED/m | 5mm | 24 VDC |  | - | - |

| Model | Page | Power | CCT | CRI |
|--------------------|------|----------|--|---|
| FINE 46 | 149 | 14,4 W/m |  | – |
| FINE 43 | 151 | 19,2 W/m |  | – |
| FINE 47 | 152 | 14,4 W/m |  | – |
| FINE 66 | 153 | 20 W/m |  | – |
| New FINE 45 | 155 | 10 W/m |    | – |
| FINE 70 | 158 | 5 W/m |     |  |
| FINE 72 | 160 | 10 W/m |     |  |
| FINE 74 | 161 | 10 W/m |     |  |
| New FINE 25 | 164 | 20 W/m |       |  |

| Lumens | Density | Width | Voltage | IP20 | IP65 | IP67 |
|--------------|------------------|--------|-----------|---|---|---|
| 38-41 Lm/W | 60 LED/m | 10mm | 24 VDC |  |  | — |
| — | 240 LED/m | 12mm | 24 VDC |  | — | — |
| — | 60 LED/m | 12mm | 24 VDC |  | — | — |
| 172 Lm/W | 840 LED/m | 12mm | 24 VDC |  | — |  |
| — | 480 LED/m | 10mm | 24 VDC |  | — | — |
| 73-186 Lm/m | 140/96 LED/m | 12,8mm | 24 VDC | — | — |  |
| 263-679 Lm/m | 140/96 LED/m | 16mm | 24 VDC | — | — |  |
| 124-320 Lm/m | 140/96 LED/m | 24mm | 24 VDC | — | — |  |
| 41-73 Lm/m | 240-480 LED/m | 25mm | 24 VDC | — | — |  |



Fine 84

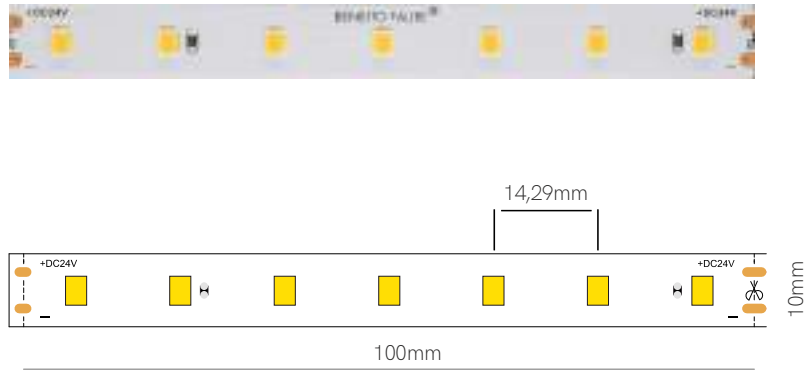

*High: IP20 = 1,5mm / IP65 = 3mm.

Technical Information

| | |
|--------------------|-----------------------------------|
| Version | Fine 84 |
| Power | 4,8 W/m |
| Color Temperature | 2.700K / 3.000K / 4.000K / 6.000K |
| Lumens | From 95 Lm/w to 102 Lm/w |
| Ingress Protection | IP20 / IP65 |

| Code | Code | Lumens | CCT | IP |
|------|-------|----------|-------|------|
| | 84270 | 95 Lm/w | 2700K | IP20 |
| | 84300 | 98 Lm/w | 3000K | IP20 |
| | 84400 | 100 Lm/w | 4000K | IP20 |
| | 84600 | 102 Lm/w | 6000K | IP20 |
| | 84275 | 90 Lm/w | 2700K | IP65 |
| | 84305 | 92 Lm/w | 3000K | IP65 |
| | 84405 | 95 Lm/w | 4000K | IP65 |
| | 84605 | 97 Lm/w | 6000K | IP65 |

Accessories

| | | | | | | | |
|---------|---------|------------------|-------------------|-----------------|-----------------|-----------------|-----------------|
| | | | | | | | |
| End Cap | End Cap | Joint | Joint | Joint | Joint | Joint | Joint |
| 20635 | 20625 | 13,8x11,55x3,9mm | 13,55x11,67x4,7mm | 24,3x14,6x7,7mm | 24,3x14,6x7,7mm | 15,4x11,5x5,7mm | 21,6x11,5x5,7mm |
| | | 20220 | 20120 | 20225 | 20125 | 20991 | 20999 |



*Available in reel of 5 or 25 meters.

5 YEARS WARRANTY | 70 LED/m | CRI ≥90 | 24 VDC | 100mm | 2835 | p.172

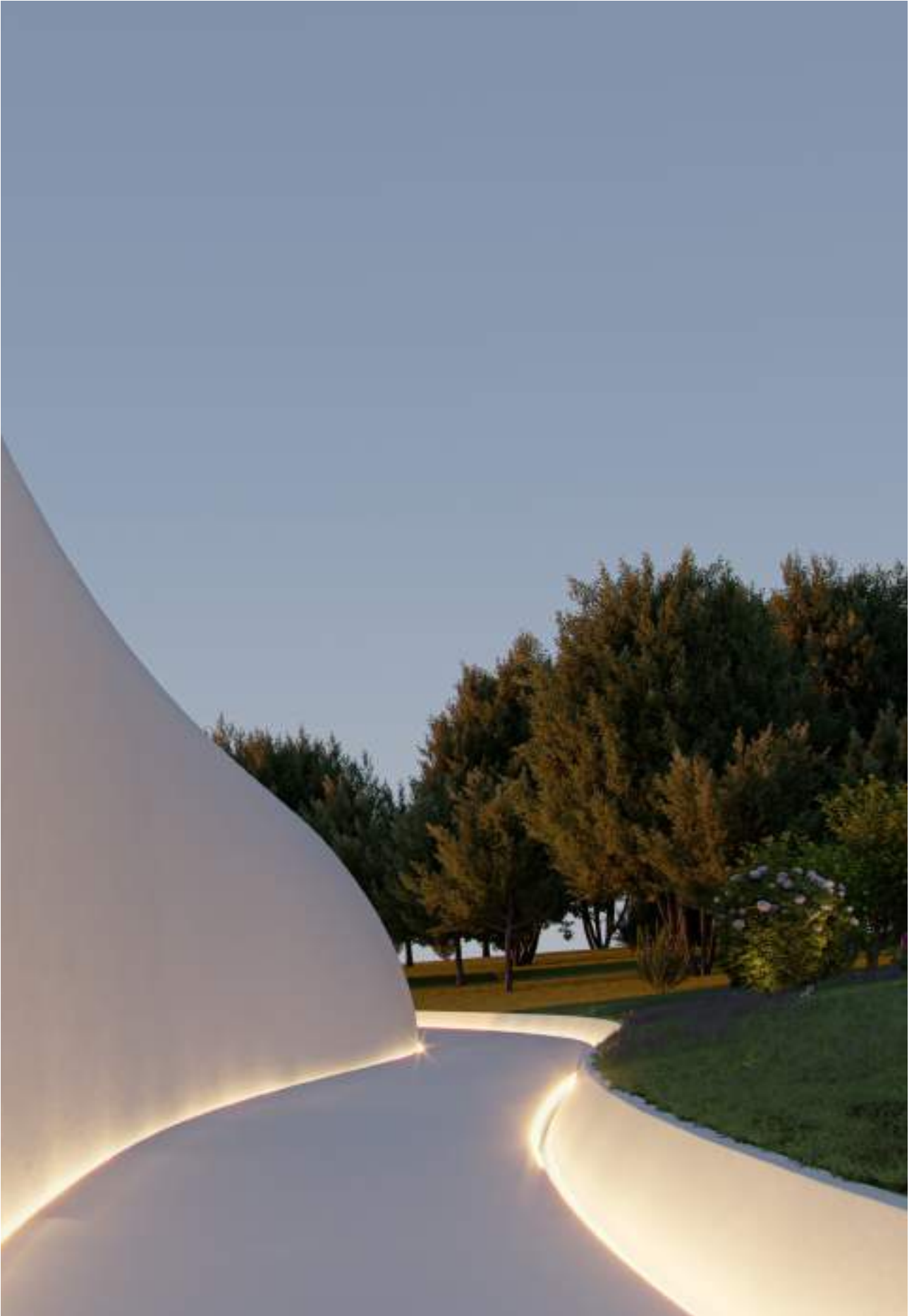

Fine 69

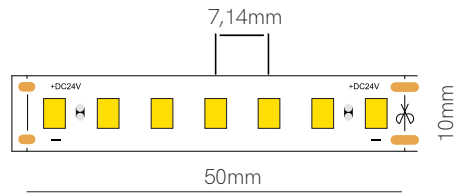

*High: IP20 = 1,5mm / IP65 = 3mm.

Technical Information

| | |
|--------------------|-----------------------------------|
| Version | Fine 69 |
| Power | 9,6 W/m |
| Color Temperature | 2.700K / 3.000K / 4.000K / 6.000K |
| Lumens | From 95 Lm/w to 102 Lm/w |
| Ingress Protection | IP20 / IP65 |

| Code | Code | Lumens | CCT | IP |
|------|-------|----------|-------|------|
| | 69270 | 95 Lm/w | 2700K | IP20 |
| | 69300 | 98 Lm/w | 3000K | IP20 |
| | 69400 | 100 Lm/w | 4000K | IP20 |
| | 69600 | 102 Lm/w | 6000K | IP20 |
| | 69275 | 90 Lm/w | 2700K | IP65 |
| | 69305 | 92 Lm/w | 3000K | IP65 |
| | 69405 | 95 Lm/w | 4000K | IP65 |
| | 69605 | 97 Lm/w | 6000K | IP65 |

Accessories

| | | | | | | | |
|------------------|------------------|------------------------------------|-------------------------------------|-----------------------------------|-----------------------------------|-----------------------------------|-----------------------------------|
| | | | | | | | |
| End Cap 20635 | End Cap 20625 | Joint 13,8x11,55x3,9mm 20220 | Joint 13,55x11,67x4,7mm 20120 | Joint 24,3x14,6x7,7mm 20225 | Joint 24,3x14,6x7,7mm 20125 | Joint 15,4x11,5x5,7mm 20991 | Joint 21,6x11,5x5,7mm 20999 |



*Available in reel of 5 or 25 meters.

5 YEARS WARRANTY | 140 LED/m | CRI ≥90 | 24 VDC | 50mm | 2835 | p.172

New

Fine 51

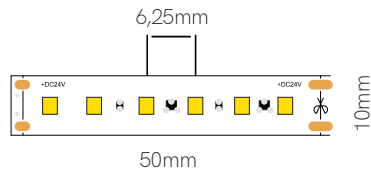
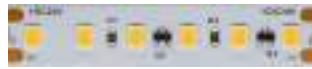

*High: P20 = 1,5mm / IP65 = 3mm.

Technical Information

| | |
|--------------------|--------------------------|
| Version | Fine 51 |
| Power | 9,6 W/m |
| Color Temperature | 2.700/3.000/4.000/6.000K |
| Lumens | 100 Lm/W |
| Ingress Protection | IP20 / IP67 |

| Code | Code | Lumens | CCT | IP |
|------|-------|----------|-------|------|
| | 51270 | 100 Lm/w | 2700K | IP20 |
| | 51300 | 100 Lm/w | 3000K | IP20 |
| | 51400 | 100 Lm/w | 4000K | IP20 |
| | 51600 | 100 Lm/w | 6000K | IP20 |
| | 51277 | 100Lm/w | 2700K | IP67 |
| | 51307 | 100 Lm/w | 3000K | IP67 |
| | 51407 | 100 Lm/w | 4000K | IP67 |
| | 51607 | 100 Lm/w | 6000K | IP67 |

Accessories

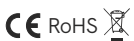
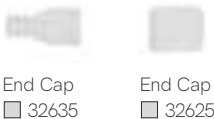

*Available in reel of 20 meters.

5 YEARS WARRANTY | 120 LED/m | CRI ≥90 | 24 VDC | ULTRALONG | 50mm | 2835 | p.172

Fine 49

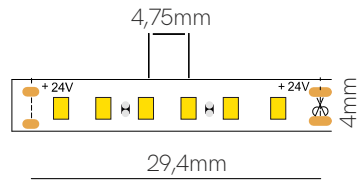

*High: IP20 = 2,2mm.

Technical Information

| | |
|--------------------|-----------------------------------|
| Version | Fine 49 |
| Power | 10 W/m |
| Color Temperature | 2.700K / 3.000K / 4.000K / 6.000K |
| Lumens | From 71 Lm/w to 77 Lm/w |
| Ingress Protection | IP20 |

| | Code | Lumens | CCT | IP |
|------|-------|---------|-------|------|
| Code | 49270 | 71 Lm/w | 2700K | IP20 |
| | 49300 | 74 Lm/w | 3000K | IP20 |
| | 49400 | 77 Lm/w | 4000K | IP20 |
| | 49600 | 74 Lm/w | 6000K | IP20 |

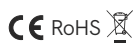

*Available in reel of 5 meters.

5 YEARS WARRANTY | 204 LED/m | CRI ≥90 | III | 24 VDC | 29,4mm | 2216 | p.172

Fine 31

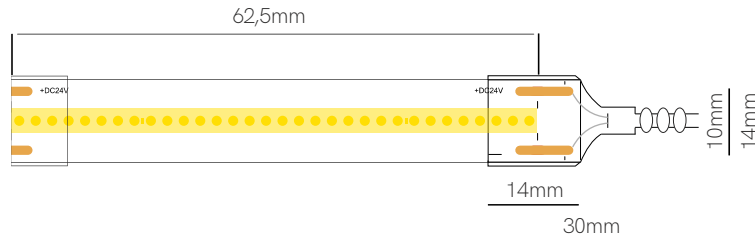

*High: IP20 = 1,5mm / IP67 = 5,8mm.

Technical Information

| | |
|--------------------|--------------------------|
| Version | Fine 31 |
| Power | 12 W/m |
| Color Temperature | 2.700K / 3.000K / 4.000K |
| Lumens | From 95 Lm/w to 100 Lm/w |
| Ingress Protection | IP20 / IP67 |

| Code | Lumens | CCT | IP |
|-------|----------|-------|------|
| 31270 | 95 Lm/w | 2700K | IP20 |
| 31300 | 98 Lm/w | 3000K | IP20 |
| 31400 | 100 Lm/w | 4000K | IP20 |
| 31277 | 95 Lm/w | 2700K | IP67 |
| 31307 | 98 Lm/w | 3000K | IP67 |
| 31407 | 100 Lm/w | 4000K | IP67 |

Accessories

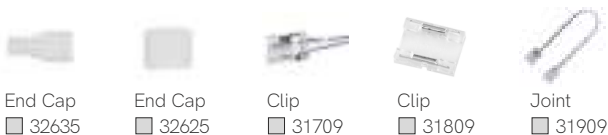

*Available in reel of 5 meters.

5 YEARS WARRANTY | 512 LED/m | CRI ≥90 | III | 24 VDC | 62,5mm | COB | p.172

Fine 44

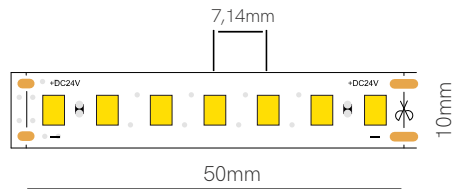

*High: IP20 = 1,5mm.

Technical Information

| | |
|--------------------|------------------------------------|
| Version | Fine 44 |
| Power | 14,4 W/m |
| Color Temperature | 2.700K / 3.700K / 5.000K / 11.600K |
| Lumens | From 80 Lm/w to 95 Lm/w |
| Ingress Protection | IP20 |

| Code | Lumens | CCT | IP |
|-------|---------|----------------|------|
| 44370 | 85 Lm/w | MEAT (3.700K) | IP20 |
| 44110 | 95 Lm/w | FISH (11.600K) | IP20 |
| 44500 | 90 Lm/w | FRUIT (5.000K) | IP20 |
| 44270 | 80 Lm/w | BREAD (2.700K) | IP20 |



Accessories



Joint
13,8x11,55x3,9mm
20220



Joint
13,55x11,67x4,7mm
20120



Joint
15,4x11,5x5,7mm
20991



Joint
21,6x11,5x5,7mm
20999



*Available in reel of 5 meters.

5 YEARS WARRANTY | 140 LED/m | CRI 75/97 | III | 24 VDC | 50mm | 2835 | p.172



Núria Riba Drawing Studio, Iguatada (Spain). Design: Carmina Orgué. Photography: Anna Batalla.

Fine 41

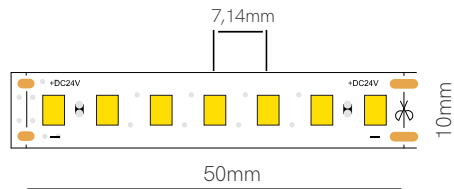

*High: IP20 = 1,5mm / IP65 = 3mm.

Technical Information

| | |
|--------------------|-----------------------------------|
| Version | Fine 41 |
| Power | 14,4 W/m |
| Color Temperature | 2.700K / 3.000K / 4.000K / 6.000K |
| Lumens | From 95 Lm/w to 102 Lm/w |
| Ingress Protection | IP20 / IP65 |

| Code | Code | Lumens | CCT | IP |
|------|-------|----------|-------|------|
| | 41270 | 95 Lm/w | 2700K | IP20 |
| | 41300 | 98 Lm/w | 3000K | IP20 |
| | 41400 | 100 Lm/w | 4000K | IP20 |
| | 41600 | 102 Lm/w | 6000K | IP20 |
| | 41275 | 90 Lm/w | 2700K | IP65 |
| | 41305 | 92 Lm/w | 3000K | IP65 |
| | 41405 | 95 Lm/w | 4000K | IP65 |
| | 41605 | 97 Lm/w | 6000K | IP65 |

Accessories

| | | | | | | | |
|---------|---------|------------------|-------------------|-----------------|-----------------|-----------------|-----------------|
| | | | | | | | |
| End Cap | End Cap | Joint | Joint | Joint | Joint | Joint | Joint |
| 20635 | 20625 | 13,8x11,55x3,9mm | 13,55x11,67x4,7mm | 24,3x14,6x7,7mm | 24,3x14,6x7,7mm | 15,4x11,5x5,7mm | 21,6x11,5x5,7mm |
| | | 20220 | 20120 | 20225 | 20125 | 20991 | 20999 |



*Available in reel of 5 or 25 meters.

5 YEARS WARRANTY | 140 LED/m | CRI ≥90 | 24 VDC | 50mm | 2835 | p.172



Fine 61

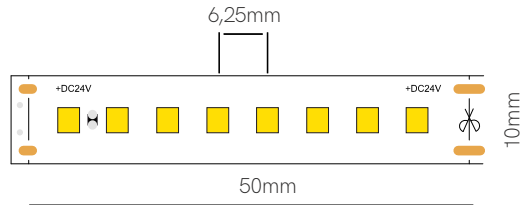

*High: IP20 = 1,5mm / IP65 = 3,5mm.

Technical Information

| | |
|--------------------|-----------------------------------|
| Version | Fine 61 |
| Power | 15 W/m |
| Color Temperature | 2.700K / 3.000K / 4.000K / 6.000K |
| Lumens | From 100 Lm/w to 125 Lm/w |
| Ingress Protection | IP20 / IP65 |

| Code | Code | Lumens | CCT | IP |
|------|------------------|----------|-------|------|
| | 61270 | 110 Lm/w | 2700K | IP20 |
| | 61300 | 115 Lm/w | 3000K | IP20 |
| | 61400 | 120 Lm/w | 4000K | IP20 |
| | 61600 | 125 Lm/w | 6000K | IP20 |
| | 61275 <i>New</i> | 110 Lm/w | 2700K | IP65 |
| | 61305 <i>New</i> | 115 Lm/w | 3000K | IP65 |
| | 61405 <i>New</i> | 120 Lm/w | 4000K | IP65 |
| | 61605 <i>New</i> | 125 Lm/w | 6000K | IP65 |

Accessories

| | | | | | | | |
|---------|---------|------------------|-------------------|-----------------|-----------------|-----------------|-----------------|
| | | | | | | | |
| End Cap | End Cap | Joint | Joint | Joint | Joint | Joint | Joint |
| 20635 | 20625 | 13,8x11,55x3,9mm | 13,55x11,67x4,7mm | 24,3x14,6x7,7mm | 24,3x14,6x7,7mm | 15,4x11,5x5,7mm | 21,6x11,5x5,7mm |



*Available in reel of 5 or 25 meters.

5 YEARS WARRANTY | 160 LED/m | CRI ≥90 | 24 VDC | 50mm | 2835 | p.172

New

Fine 32 N

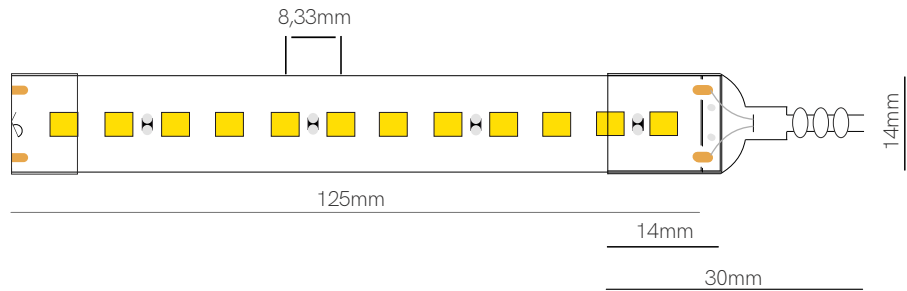

*High: IP65 = 5,25mm.

Technical Information

| | |
|--------------------|-----------------------------------|
| Version | Fine 32-N |
| Power | 15 W/m |
| Color Temperature | 2.700K / 3.000K / 4.000K / 6.000K |
| Lumens | From 100 Lm/w to 110 Lm/w |
| Ingress Protection | IP65 |

| | Code | Lumens | CCT | IP |
|------|---------|----------|-------|------|
| Code | 32275-N | 100 Lm/w | 2700K | IP65 |
| | 32305-N | 105 Lm/w | 3000K | IP65 |
| | 32405-N | 110 Lm/w | 4000K | IP65 |
| | 32605-N | 110 Lm/w | 6000K | IP65 |

Accessories

| | | | | | | |
|--------------------|--------------------|----------------|----------------------|---------------------|-----------------|------------------|
| | | | | | | |
| End Cap ■ 32635 | End Cap ■ 32625 | Kit ■ 32699 | Join 180° ■ 32899 | Join 90° ■ 32499 | Clip ■ 32900 | Joint ■ 32299 |

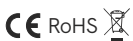

*Available in reel of 5 or 50 meters.

3 YEARS WARRANTY | 112 LED/m | | CRI ≥80 | 220/240 VAC | 125mm | TRIAC DIMM | 2835 | p.172

Fine 52

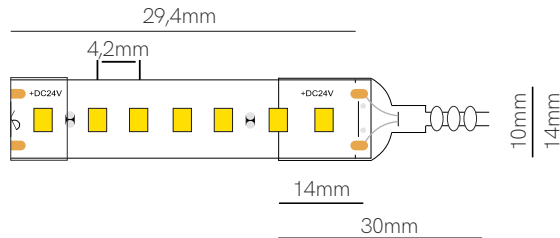

*High: IP20 = 1,5mm / IP67 = 5,8mm.

Technical Information

| | |
|--------------------|-----------------------------------|
| Version | Fine 52 |
| Power | 22 W/m |
| Color Temperature | 2.700K / 3.000K / 4.000K / 6.000K |
| Lumens | From 97 Lm/w to 112 Lm/w |
| Ingress Protection | IP20 / IP67 |

| Code | Code | Lumens | CCT | IP |
|------|-------|----------|-------|------|
| | 52270 | 97 Lm/w | 2700K | IP20 |
| | 52300 | 103 Lm/w | 3000K | IP20 |
| | 52400 | 108 Lm/w | 4000K | IP20 |
| | 52600 | 112 Lm/w | 6000K | IP20 |
| | 52277 | 97 Lm/w | 2700K | IP67 |
| | 52307 | 103 Lm/w | 3000K | IP67 |
| | 52407 | 108 Lm/w | 4000K | IP67 |
| | 52607 | 112 Lm/w | 6000K | IP67 |

Accessories

| | | | |
|--------------------|--------------------|--------------------------------------|---------------------------------------|
| | | | |
| End Cap ■ 32635 | End Cap ■ 32625 | Joint 13,8x11,55x3,9mm ■ 20220 | Joint 13,55x11,67x4,7mm ■ 20120 |



*Available in reel of 5 meters.

5 YEARS WARRANTY | 238 LED/m | CRI ≥90 | 24 VDC | 29,4mm | 2835 | p.172

New

Fine 56

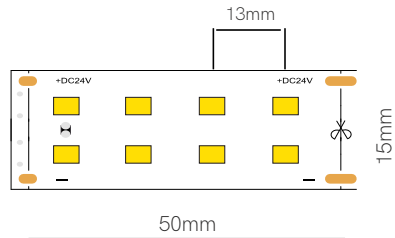
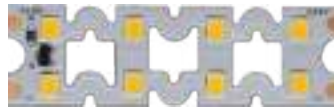

*High: IP20 = 1,5mm.

Technical Information

| | |
|--------------------|---|
| Version | Fine 56 |
| Power | 22 W/m |
| Color Temperature | 2.700K / 3.000K / 4.000K / 2.700-6.000K |
| Lumens | From 130 Lm/w to 170 Lm/w |
| Ingress Protection | IP20 |

| Code | Lumens | CCT | IP |
|-------|----------|-------|------|
| 56270 | 155 Lm/w | 2700K | IP20 |
| 56300 | 160 Lm/w | 3000K | IP20 |
| 56400 | 170 Lm/w | 4000K | IP20 |
| 56360 | 130 Lm/w | CCT | IP20 |



*Available in reel of 5 meters.

5 YEARS WARRANTY | 160 LED/m | CRI ≥80 | III | 24 VDC | 50 mm | | 2835 | p.172

Fine 55

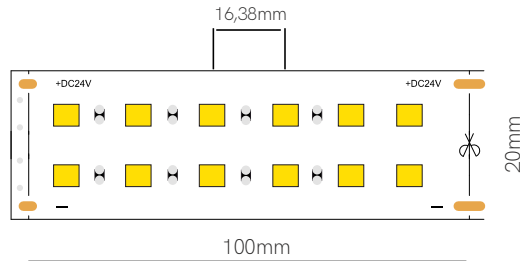

*High: IP20 = 1,5mm.

Technical Information

| | |
|--------------------|--------------------------|
| Version | Fine 55 |
| Power | 24 W/m |
| Color Temperature | 2.700K / 3.000K / 4.000K |
| Lumens | From 80 Lm/w to 86 Lm/w |
| Ingress Protection | IP20 |

| Code | Lumens | CCT | IP |
|-------|---------|-------|------|
| 55270 | 80 Lm/w | 2700K | IP20 |
| 55300 | 83 Lm/w | 3000K | IP20 |
| 55400 | 86 Lm/w | 4000K | IP20 |



*Available in reel of 5 meters.

5 YEARS WARRANTY | 120 LED/m | CRI >90 | III | 24 VDC | 100mm | | 5050 | p.172

Fine 36

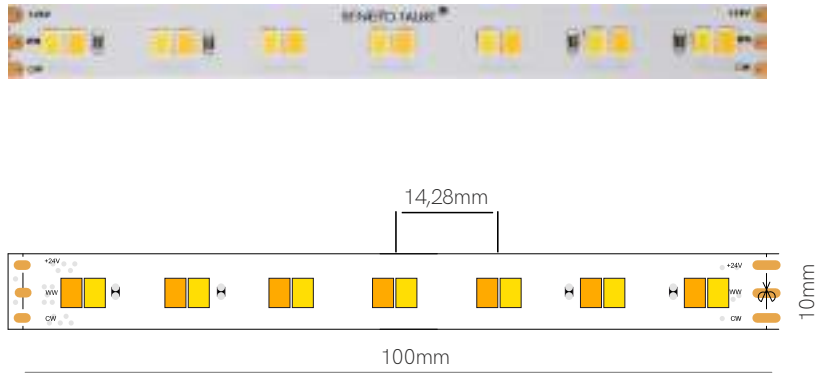

*High: IP20 = 2,2mm.

Technical Information

| | |
|--------------------|--------------|
| Version | Fine 36 |
| Power | 12 W/m |
| Color Temperature | 2.700-5.000K |
| Lumens | 100 Lm/w |
| Ingress Protection | IP20 |

| | Code | Lumens | CCT | IP |
|------|-------|----------|--------------|------|
| Code | 36360 | 100 Lm/w | 2.700-5.000K | IP20 |

Accessories

- 
 End Cap
 20635
- 
 End Cap
 20625
- 
 Joint
 13,57x11,63x3,5mm
 20230
- 
 Joint
 13,57x11,63x4,7mm
 20130



*Available in reel of 5 meters.

5 YEARS WARRANTY | 140 LED/m | CRI ≥90 | III | 24 VDC | 100mm |  |  2835 |  p.172

New

Fine 42

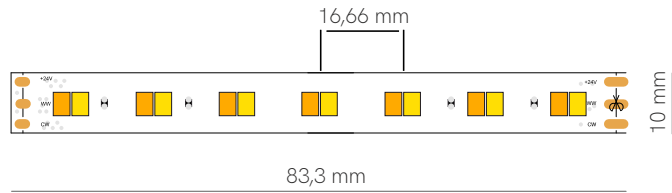

*High: IP20 = 1,5mm / IP65 = 3mm.

Technical Information

| | |
|--------------------|--------------|
| Version | Fine 42 |
| Power | 19,2 W/m |
| Color Temperature | 1.800-4.000K |
| Lumens | 90 Lm/W |
| Ingress Protection | IP20 / IP65 |

| Code | Code | Lumens | CCT | IP |
|-------|---------|--------------|------|----|
| 42360 | 90 Lm/W | 1.800-4.000K | IP20 | |
| 42365 | 90 Lm/W | 1.800-4.000K | IP65 | |

Accessories

- 
 End Cap
 20635
- 
 End Cap
 20625
- 
 Joint
 13,57x11,63x3,5mm
 20230
- 
 Joint
 13,57x11,63x4,7mm
 20130
- 
 Joint
 24,3x14,6x7,7mm
 20235
- 
 Joint
 24,3x14,6x7,7mm
 20135

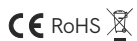

*Available in reel of 5 or 25 meters.

5 YEARS WARRANTY | 168 LED/m | CRI ≥90 | III | 24 VDC | 83,3mm |  |  2835 |  p.172

Fine 50

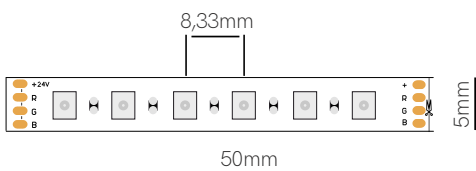

*High: IP20 = 2,2mm.

Technical Information

| | |
|--------------------|---------|
| Version | Fine 50 |
| Power | 9,6 W/m |
| Color Temperature | RGB |
| Lumens | 58 Lm/w |
| Ingress Protection | IP20 |

| | Code | Lumens | CCT | IP |
|------|-------|---------|-----|------|
| Code | 50460 | 58 Lm/w | RGB | IP20 |

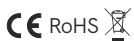

*Available in reel of 5 meters.

3 YEARS WARRANTY | 120 LED/m | 24 VDC | | 50mm | 2835 | p.172

Fine 46

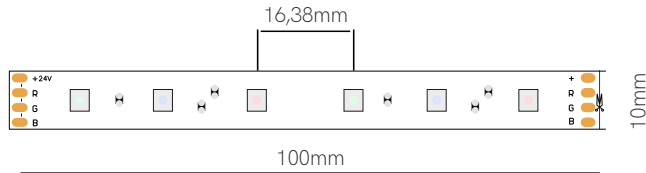

*High: IP20 = 2,2mm / IP65 = 3,5mm.

Technical Information

| | |
|--------------------|-------------------------|
| Version | Fine 46 |
| Power | 14,4 W/m |
| Color Temperature | RGB |
| Lumens | From 38 Lm/w to 41 Lm/w |
| Ingress Protection | IP20 / IP65 |

| | Code | Lumens | CCT | IP |
|------|-------|---------|-----|------|
| Code | 46460 | 38 Lm/w | RGB | IP20 |
| | 46465 | 41 Lm/w | RGB | IP65 |

Accessories



End Cap
20635



End Cap
20625



Joint
13,54x11,7x4,1mm
20240



Joint
13,56x13,46x4,7mm
20140



Joint
24,3x14,6x7,68mm
20245



Joint
24,3x14,6x7,68mm
20145

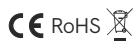

*Available in reel of 5 or 25 meters.

5 YEARS WARRANTY | 60 LED/m | 24 VDC | III | 50mm | 5050 | p.172



Fine 43

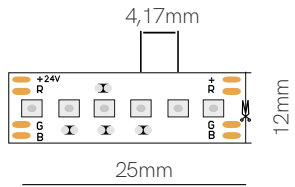

*High: IP20 = 1,5mm.

Technical Information

| | |
|--------------------|----------|
| Version | Fine 43 |
| Power | 19,2 W/m |
| Color Temperature | RGB |
| Lumens | - |
| Ingress Protection | IP20 |

| | Code | Lumens | CCT | IP |
|------|-------|--------|-----|------|
| Code | 43430 | - | RGB | IP20 |



*Available in reel of 5 meters.

3 YEARS WARRANTY | 240 LED/m | 24 VDC | III | 25mm | 3535 | p.172

Fine 47

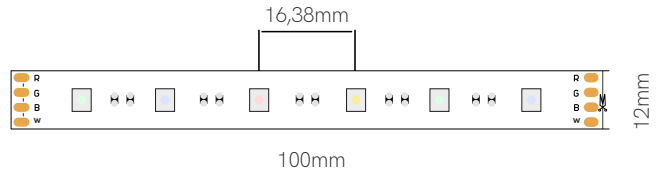
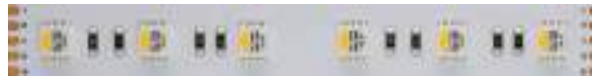

*High: IP20 = 2,2mm.

Technical Information

| | |
|--------------------|----------------|
| Version | Fine 47 |
| Power | 14,4 W/m |
| Color Temperature | RGB-W (3.000K) |
| Lumens | - |
| Ingress Protection | IP20 |

| | Code | Lumens | CCT | IP |
|------|-------|--------|-------|------|
| Code | 47430 | - | RGB-W | IP20 |

Accessories



Joint
13,5x13,73x4,2mm
□ 20150



Joint
13,5x13,55x4,8mm
□ 20250

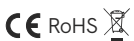

*Available in reel of 5 meters.

5 YEARS WARRANTY | 60 LED/m | 24 VDC | III | 100mm ✂ | 5050 | p.172

Fine 66

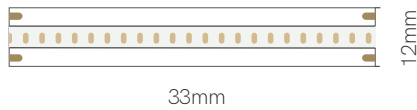
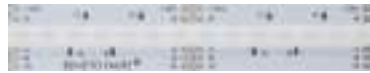

*High: IP20 = 2,2mm / IP67 = 3,5mm.

Technical Information

| | |
|--------------------|----------------|
| Version | Fine 66 |
| Power | 20 W/m |
| Color Temperature | RGB-W (2.700K) |
| Lumens | 172 Lm/w |
| Ingress Protection | IP20 / IP67 |

| | Code | Lumens | CCT | IP |
|------|-------|----------|-------|------|
| Code | 66470 | 172 Lm/w | RGB-W | IP20 |
| | 66477 | 172 Lm/w | RGB-W | IP67 |

Accessories



End Cap
32635

End Cap
32625



*Available in reel of 5 meters.

5 YEARS WARRANTY | 840 LED/m | 24 VDC | III | 33mm | | CSP | p.172



New

Fine 45

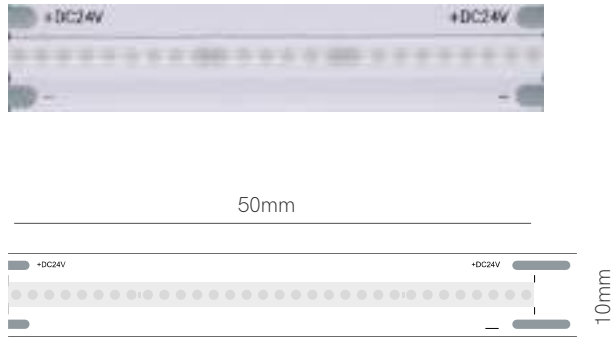

*High: IP20 = 2,2mm.

Technical Information

| | |
|--------------------|--------------------|
| Version | Fine 45 |
| Power | 10W |
| Color Temperature | Red / Green / Blue |
| Lumens | - |
| Ingress Protection | IP20 |

| Code | Code | Lumens | CCT | IP |
|------|-------|--------|-------|------|
| | 45220 | - | RED | IP20 |
| | 45310 | - | GREEN | IP20 |
| | 45520 | - | BLUE | IP20 |

Accessories



Clip
31709



Clip
31809



Joint
31909

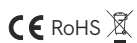

*Available in reel of 10 meters.

5 YEARS WARRANTY | 480 LED/m | 24 VDC | III | 50 mm | CSP | p.172

New

NEON^{IP}₆₇

LED Strips

Beneito Faure's new 24V flexible neon strips allow you to choose between different light powers, protections, densities and lengths, while maintaining the safety and durability of low voltage installations.

The lighting needs for the nautical industry require a customized and high-performance solution.

All Beneito Faure neon strips have a certificate of resistance to corrosion, resistance to saline alkalis and anti-UV resistance, in addition to an ingress protection of IP67.



Las nuevas tiras flexibles neón de Beneito Faure de 24V permiten elegir entre diferentes rendimientos lumínicos, protecciones, densidades y longitudes, manteniendo la seguridad y la vida útil de las instalaciones de baja tensión.

Las necesidades de iluminación para el sector náutico requieren una solución personalizada y de alto rendimiento.

Todas las tiras neón de Beneito Faure tienen el certificado de resistencia a la corrosión, resistencia a los álcalis salinos y resistencia anti UV, además de un índice de protección lumínico de IP67.



Fine 70

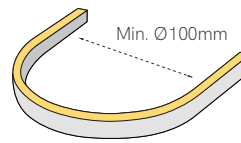
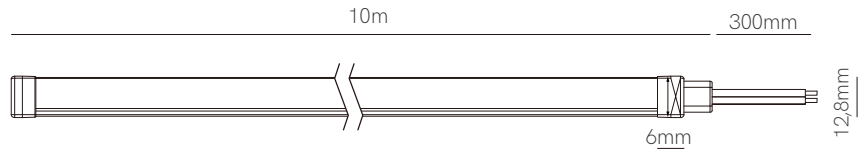

- 2.700K
- 3.000K
- 4.000K
- RGB



Technical Information

| | |
|--------------------|--------------------------------|
| Version | Fine 70 |
| Power | 5 W/m |
| Color Temperature | 2.700K / 3.000K / 4.000K / RGB |
| Lumens | From 73 Lm/m to 186 Lm/m |
| Ingress Protection | IP67 |

| Code | Lumens | CCT | IP |
|-------|----------|-------|------|
| 70277 | 178 Lm/m | 2700K | IP67 |
| 70307 | 154 Lm/m | 3000K | IP67 |
| 70407 | 186 Lm/m | 4000K | IP67 |
| 70437 | 73 Lm/m | RGB | IP67 |

*Available in reel of 10 meters.

Accessories

| | | | | | |
|------------------|------------------|------------------|------------------------------|------------------------------|----------------------------------|
| | | | | | |
| End Cap 70627 | End Cap 70967 | End Cap 70637 | Clip 19,7x8x13mm 70330 | Clip 1000x8x13mm 70119 | Clip 1000x8,5x12,5mm 70350 |

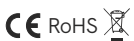

5 YEARS WARRANTY | 24 VDC | 50mm | | 140 LED/m | 96 LED/m (RGB) | 2835 | 4040 (RGB) | CRI >= 90 | | | |



Fine 72

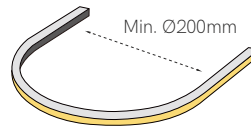
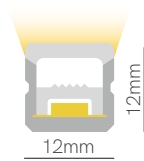

- 2.700K
- 3.000K
- 4.000K
- RGB



Technical Information

| | |
|--------------------|--------------------------------|
| Version | Fine 72 |
| Power | 10 W/m |
| Color Temperature | 2.700K / 3.000K / 4.000K / RGB |
| Lumens | From 263 Lm/m to 679 Lm/m |
| Ingress Protection | IP67 |

| Code | Code | Lumens | CCT | IP |
|------|-------|----------|-------|------|
| | 72277 | 484 Lm/m | 2700K | IP67 |
| | 72307 | 561 Lm/m | 3000K | IP67 |
| | 72407 | 679 Lm/m | 4000K | IP67 |
| | 72437 | 263 Lm/m | RGB | IP67 |

*Available in reel of 10 meters.

Accessories

| | | | | | | | |
|----------|---------|---------|---------|------------------|------------------|----------------|-----------------|
| | | | | | | | |
| End Cap | End Cap | End Cap | End Cap | Clip | Clip | Clip | Extension cable |
| 72967-L2 | 72967-2 | 72627-2 | 72637 | 20,2x16,8x12,5mm | 1000x19,2x17,8mm | 1000x26,4x18mm | 77946 (Mono) |
| 72967-L4 | 72967-4 | 72627-4 | | 77530 | 77519 | 77350 | 77920 (RGB) |

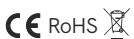

5 YEARS WARRANTY | 24 VDC | 50mm / 62,5mm (RGB) | 140 LED/m | 96 LED/m (RGB) | 2835 | 4040 (RGB) | CRI >90 | III | Sun, Lightbulb, Plug icons

Fine 74

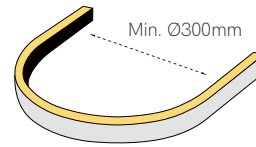
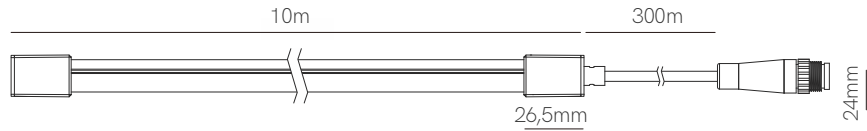

- 2.700K
- 3.000K
- 4.000K
- RGB



Technical Information

| | |
|--------------------|--------------------------------|
| Version | Fine 74 |
| Power | 10 W/m |
| Color Temperature | 2.700K / 3.000K / 4.000K / RGB |
| Lumens | From 124 Lm/m to 320 Lm/m |
| Ingress Protection | IP67 |

| Code | Code | Lumens | CCT | IP |
|------|-------|----------|-------|------|
| | 74277 | 271 Lm/m | 2700K | IP67 |
| | 74307 | 269 Lm/m | 3000K | IP67 |
| | 74407 | 320 Lm/m | 4000K | IP67 |
| | 74437 | 124 Lm/m | RGB | IP67 |

*Available in reel of 10 meters.

Accessories

| | | | | | | | |
|----------|---------|---------|---------|------------------|------------------|----------------|-----------------|
| | | | | | | | |
| End Cap | End Cap | End Cap | End Cap | Clip | Clip | Clip | Extension cable |
| 74967-L2 | 74967-2 | 74627-2 | 74637 | 20,2x16,8x12,5mm | 1000x19,2x17,8mm | 1000x26,4x18mm | 77946 (Mono) |
| 74967-L4 | 74967-4 | 74627-4 | | 77330 | 77119 | 77350 | 77920 (RGB) |



5 YEARS WARRANTY | 24 VDC | 50mm / 55,5mm (RGB) | 140 LED/m | 96 LED/m (RGB) | | CRI >90 | | | |



Neon LED Strips



New

Fine 25

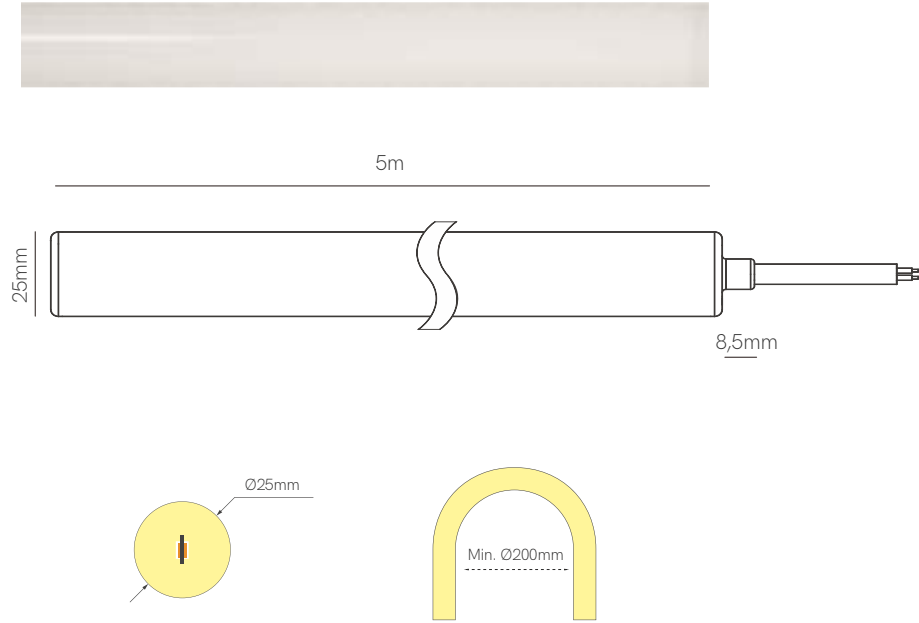

Technical Information

| | |
|--------------------|--|
| Version | Fine 25 |
| Power | 20 W/m |
| Color Temperature | 2.400K / 2.700K / 3.000K / 4.000K / 2.700-6.500K / RGB |
| Lumens | From 41 Lm/m to 73 Lm/m |
| Ingress Protection | IP67 |

| Code | Lumens | CCT | IP |
|-------|---------|-------------|------|
| 25247 | 60 Lm/m | 2400K | IP67 |
| 25277 | 65 Lm/m | 2700K | IP67 |
| 25307 | 69 Lm/m | 3000K | IP67 |
| 25407 | 73 Lm/m | 4000K | IP67 |
| 25367 | 70 Lm/m | 2700K-6500K | IP67 |
| 25467 | 41 Lm/m | RGB | IP67 |

*Available in reel of 5 meters.

Accessories

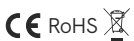

5 YEARS WARRANTY | 24 VDC | 320 LED/m | 480 LED/m (CCT) | 240 LED/m (RGB) | 10mm / 50mm (CCT-RGB) |
 |
 2835 |
 4040 (RGB) |
 CRI ≥90 |
 |
 |



LED Strips accessories



Control Basic

| Code | Version | VDC IN | Ampers | Size |
|-------|--|---------------|--------|-------------|
| 90990 | <input type="checkbox"/> RF Mono Remote Basic | 5 VDC (3xAAA) | - | 120x46x18mm |
| 89260 | <input type="checkbox"/> RF CCT Remote Basic | 5 VDC (3xAAA) | - | 120x46x18mm |
| 88460 | <input type="checkbox"/> RF RGB Remote Basic | 5 VDC (3xAAA) | - | 120x46x18mm |
| 91430 | <input type="checkbox"/> RF RGB-W Remote Basic | 5 VDC (3xAAA) | - | 120x46x18mm |
| 86019 | <input type="checkbox"/> Controller Mono/CCT/RGB Basic | 12-24 VDC | 5Ax3C | 145x46x18mm |
| 87029 | <input type="checkbox"/> Controller RGB-W Basic | 12-24 VDC | 5Ax3C | 145x46x18mm |

(((•))) RF |



Control Top

| Code | Version | VDC IN | Ampers | Size |
|-------|---|-------------------|--------|-------------|
| 81990 | <input checked="" type="checkbox"/> RF Mono Remote Top | 4,5 VDC (3xAAA) | - | 120x55x17mm |
| 80260 | <input checked="" type="checkbox"/> RF CCT Remote Top | 4,5 VDC (3xAAA) | - | 120x55x17mm |
| 79430 | <input checked="" type="checkbox"/> RF RGB-W Remote Top | 4,5 VDC (3xAAA) | - | 120x55x17mm |
| 77019 | <input type="checkbox"/> Controller Mono/CCT/RGB/RGB-W Top | 12-23 VDC / 5Ax4C | 5Ax4C | 178x46x18mm |
| 82995 | <input type="checkbox"/> RF Mono Button Panel Top | 24 VDC | - | 86x86x41mm |
| 83475 | <input checked="" type="checkbox"/> RF RGB-W Button Panel Top | 24 VDC | - | 86x86x41mm |

(((•))) RF |



3 YEARS WARRANTY | IP 20



Control Casambi

| Code | Version | Power Max | VDC IN | Size |
|-------|--|---------------|-------------|------------------|
| 57241 | <input type="checkbox"/> Xpress Casambi White | - | - | 90x90x12mm |
| 57242 | <input checked="" type="checkbox"/> Xpress Casambi Black | - | - | 90x90x12mm |
| 59249 | <input type="checkbox"/> Control CBU-PWM4 | 4x1,5A (144W) | 12/24 VDC | 72,6x30x18mm |
| 59739 | <input type="checkbox"/> Relay Casambi | 230W | 200/240 VAC | 32x32x20mm |
| 59769 | <input type="checkbox"/> Controller End of phase | 50W | 85/240 VAC | 40,4x36x2x14mm |
| 59789 | <input type="checkbox"/> Interface 0-10/1-10 Dali | - | 220/240 VAC | 56,5x35,8x22,3mm |
| 57588 | <input type="checkbox"/> New Controller PWM4+Push | 4x5A4C | 12/24 VDC | 88x54x25mm |



Control Tuya

| Code | Version | Power Max | VDC IN | Size |
|-------|--|-------------|----------------|-------------|
| 85360 | <input checked="" type="checkbox"/> RF CCT | - | 3VDC (CD20302) | 139x36x11mm |
| 85460 | <input checked="" type="checkbox"/> RF RGB | - | 3VDC (CR20302) | 139x36x11mm |
| 85470 | <input checked="" type="checkbox"/> RF RGB-W | - | 3VDC (CR20302) | 139x36x11mm |
| 85890 | <input checked="" type="checkbox"/> RF Dimming | - | 3VDC (CR20302) | 139x36x11mm |
| 22856 | <input type="checkbox"/> Controller Tuya 5C | 5x3A (360W) | 12/24 VDC | 114x38x20mm |
| 22821 | <input type="checkbox"/> New Controller Tuya 2C | 2x5A (240W) | 12/36W | 114x38x20mm |

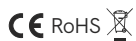

3 YEARS WARRANTY | IP 20



Control Push / Triac

| Code | Version | Power Max | VDC IN | Size |
|-------|---|--------------|----------------|-------------|
| 85890 | <input checked="" type="checkbox"/> RF Dimming | - | 3 VDC (CD2032) | 139x36x11mm |
| 85894 | <input checked="" type="checkbox"/> New RF Dimming 4 Zones | - | 3 VDC (CD2032) | 138x50x22mm |
| 84431 | <input checked="" type="checkbox"/> New RF Dimming Panel | - | 3 VDC (CD2032) | 86x86x23mm |
| 22726 | <input type="checkbox"/> Control Push - Dim | 8A (40-288W) | 5-36 VDC | 97x33x18mm |
| 85876 | <input type="checkbox"/> Controller Wifi RF Push Triac Tuya | 1,5A | 100-240 VAC | 52x52x26mm |
| 85884 | <input type="checkbox"/> Controller RF Push Triac | 2A | 100-240 VAC | 110x48x67mm |



Control Dali Push Triac

| Code | Version | Power Max | VDC IN | Size |
|-------|---|-----------|-------------|-------------|
| 22948 | <input type="checkbox"/> Controller Dali+Push/Triac | 1,5A | 100/240 VAC | 187x46x22mm |



Control Dali Push

| Code | Version | VDC IN / Amperes | Size |
|-------|--|--------------------------------|-------------|
| 22490 | <input checked="" type="checkbox"/> Controller PWM Dali Push 1-10V | 12-24 VDC / 12A (Max 144-288W) | 155x51x26mm |
| 22499 | <input checked="" type="checkbox"/> Controller PWM Dali Push 1-10V | 12-24 VDC / 5A (Max 60-120W) | 132x22x20mm |



3 YEARS WARRANTY | IP 20



Motion Sensor

| Code | Version | Power Max | VDC IN | Size |
|-------|--|--------------|-----------|---------|
| 85993 | ■ Mini Sensor Mono PWM | 6A (72-144W) | 12/24 VDC | 55x10mm |
| 85263 | ■ Mini Sensor CCT PWM | 4Ax2C | 12/24 VDC | 55x10mm |
| 85183 | ■ New Motion Sensor Pir | 8A (96-192W) | 12/24 VDC | 55x10mm |
| 85332 | □ New Motion Sensor Surface Pir | 4A (48-96W) | 12/24 VDC | 45x62mm |



Motion Sensor

| Code | Version | Power Max | VDC IN | Size |
|-------|---|-------------|-----------|---------|
| 85220 | □ New Sensor Pir Double Surface | 4A (48-96W) | 12/24 VDC | 12x12mm |
| 85120 | □ New Sensor Simple Surface | 4A (48-96W) | 12/24 VDC | 12x12mm |
| 85626 | □ New Sensor Pir Double Recessed | 4A (48-96W) | 12/24 VDC | 14x18mm |
| 85336 | □ New Sensor Simple Recessed | 4A (48-96W) | 12/24 VDC | 14x18mm |



3 YEARS WARRANTY | IP 20

Power Supplies 24V



Power Supplies Standard

| Code | Power | IP | VAC IN | VDC OUT | Size |
|--------------------------------|-------|------|-------------|---------|---------------|
| 62430 <input type="checkbox"/> | 30W | IP20 | 198/264 VAC | 24 VDC | 162x42x30mm |
| 62460 <input type="checkbox"/> | 60W | IP20 | 198/264 VAC | 24 VDC | 187x45x30mm |
| 62475 <input type="checkbox"/> | 75W | IP20 | 198/264 VAC | 24 VDC | 187x45x30,5mm |
| 62412 <input type="checkbox"/> | 120W | IP20 | 198/264 VAC | 24 VDC | 268x45x30,5mm |
| 62415 <input type="checkbox"/> | 150W | IP20 | 198/264 VAC | 24 VDC | 268x45x30,5mm |



Power Supplies Basic

| Code | Power | IP | VAC IN | VDC OUT | Size |
|--------------------------------|-------|------|------------|---------|-----------------|
| 22420 <input type="checkbox"/> | 20W | IP67 | 90/264 VAC | 24 VDC | 118x35x26mm |
| 22435 <input type="checkbox"/> | 36W | IP67 | 90/264 VAC | 24 VDC | 148x40x30mm |
| 22460 <input type="checkbox"/> | 60W | IP67 | 90/264 VAC | 24 VDC | 162,5x45,5x32mm |
| 22410 <input type="checkbox"/> | 100W | IP67 | 90/264 VAC | 24 VDC | 190x52x37mm |
| 22415 <input type="checkbox"/> | 150W | IP67 | 90/264 VAC | 24 VDC | 191x63x37,5mm |



Power Supplies Top

| Code | Power | IP | VAC IN | VDC OUT | Size |
|--------------------------------|-------|------|------------|---------|-----------------|
| 22424 <input type="checkbox"/> | 240W | IP67 | 90/305 VAC | 24 VDC | 244,2x68x38,8mm |
| 22430 <input type="checkbox"/> | 300W | IP67 | 90/305 VAC | 24 VDC | 246x77x39,5mm |
| 22432 <input type="checkbox"/> | 320W | IP67 | 90/305 VAC | 24 VDC | 252x90x43,8mm |



CE RoHS 

PF >0,9 | 3 YEARS WARRANTY



Power Supplies Slim

| Code | | Power | IP | VAC IN | VDC OUT | Size |
|---------|------------------------------|-------|------|-------------|---------|-------------|
| TR3024 | <input type="checkbox"/> New | 30W | IP20 | 176/264 VAC | 24 VDC | 261x30x17mm |
| TR6024 | <input type="checkbox"/> New | 60W | IP20 | 176/264 VAC | 24 VDC | 329x30x17mm |
| TR10024 | <input type="checkbox"/> New | 100W | IP20 | 176/264 VAC | 24 VDC | 365X30X18mm |



Power Supplies Triac

| Code | | Power | IP | VAC IN | VDC OUT | Size |
|-------|---|-------|------|-------------|---------|-------------|
| 24609 | <input type="checkbox"/> New | 60W | IP20 | 200/240 VAC | 24 VDC | 178x61x24mm |
| 24109 | <input checked="" type="checkbox"/> New | 100W | IP66 | 200/240 VAC | 24 VDC | 230x70x43mm |
| 24159 | <input checked="" type="checkbox"/> New | 150W | IP66 | 200/240 VAC | 24 VDC | 256x78x47mm |



Power Supplies Dali

| Code | | Power | IP | VAC IN | VDC OUT | Size |
|-------|---|-------|------|-------------|---------|---------------|
| 24758 | <input checked="" type="checkbox"/> New | 75W | IP67 | 100/305 VAC | 24 VDC | 180x63x35,5mm |
| 24108 | <input checked="" type="checkbox"/> New | 100W | IP67 | 100/305 VAC | 24 VDC | 199x63x35,5mm |
| 24208 | <input checked="" type="checkbox"/> New | 150W | IP67 | 100/305 VAC | 24 VDC | 219x63x35,5mm |



PF >0,9 | 3 YEARS WARRANTY

Compatibility Table

| FINE | 84 | 69 | 51 | 49 | 31 | 44 | 41 | 61 | 32 N | |
|--------|-----------------------|-----------------------|----|-----------------------|-----------------------|-----------------------|-----------------------|-----------------------|-----------------------|-----------------------|
| BOX-18 | ✓ | ✓ | ✓ | ✓ | IP20 ✓ IP67 — | ✓ | ✓ | ✓ | ✓ | |
| BOX-17 | ✓ | ✓ | ✓ | ✓ | IP20 ✓ IP67 — | ✓ | ✓ | ✓ | ✓ | |
| BOX-16 | ✓ | ✓ | ✓ | ✓ | ✓ | ✓ | ✓ | ✓ | — | |
| BOX-15 | ✓ | ✓ | ✓ | ✓ | ✓ | ✓ | ✓ | ✓ | — | |
| BOX-19 | ✓ | ✓ | ✓ | ✓ | IP20 ✓ IP67 — | ✓ | ✓ | ✓ | ✓ | |
| BOX-10 | ✓ | ✓ | ✓ | ✓ | IP20 ✓ IP67 — | ✓ | ✓ | ✓ | ✓ | |
| BOX-35 | ✓ | ✓ | ✓ | ✓ | ✓ | — | ✓ | ✓ | ✓ | |
| BOX-38 | ✓ | ✓ | ✓ | ✓ | ✓ | — | ✓ | ✓ | ✓ | |
| BOX-12 | — | — | — | ✓ | — | — | — | — | — | |
| BOX-11 | — | — | — | ✓ | — | — | — | — | — | |
| BOX-13 | IP20 ✓ IP65 — | IP20 ✓ IP65 — | ✓ | ✓ | ✓ | — | IP20 ✓ IP65 — | — | — | |
| BOX-14 | ✓ | ✓ | ✓ | ✓ | ✓ | ✓ | ✓ | — | — | |
| BOX-23 | ✓ | ✓ | ✓ | ✓ | ✓ | ✓ | ✓ | ✓ | ✓ | |
| BOX-53 | ✓ | ✓ | ✓ | ✓ | ✓ | ✓ | ✓ | ✓ | ✓ | |
| BOX-21 | ✓ | ✓ | ✓ | ✓ | ✓ | — | ✓ | — | — | |
| BOX-27 | ✓ | ✓ | ✓ | ✓ | ✓ | — | ✓ | — | — | |
| BOX-22 | ✓ | ✓ | ✓ | ✓ | ✓ | — | ✓ | — | — | |
| BOX-29 | IP20 ✓ IP65 — | IP20 ✓ IP65 — | ✓ | — | — | — | IP20 ✓ IP65 — | — | — | |
| BOX-30 | 12mm ✓ 20mm ✓ | 12mm ✓ 20mm ✓ | ✓ | 12mm ✓ 20mm ✓ | 12mm ✓ 20mm ✓ | 12mm ✓ 20mm ✓ | 12mm ✓ 20mm ✓ | 12mm ✓ 20mm ✓ | 12mm ✓ 20mm ✓ | 12mm ✓ 20mm — |
| BOX-33 | ✓ | ✓ | ✓ | ✓ | ✓ | ✓ | ✓ | ✓ | ✓ | |
| BOX-39 | ✓ | ✓ | ✓ | ✓ | ✓ | ✓ | ✓ | ✓ | ✓ | |
| BOX-28 | ✓ | ✓ | ✓ | ✓ | ✓ | ✓ | ✓ | ✓ | ✓ | |
| BOX-37 | ✓ | ✓ | ✓ | ✓ | ✓ | ✓ | ✓ | ✓ | ✓ | |

| | 52 | 56 | 55 | 36 | 42 | 50 | 46 | 43 | 47 | 66 | 45 | |
|--|-----------|-----------|-----------|-----------|-----------|-----------|-----------|-----------|-----------|-----------|-----------|-----------|
| | — | — | — | ✓ | ✓ | ✓ | ✓ | ✓ | ✓ | ✓ | ✓ | |
| | — | — | — | ✓ | ✓ | ✓ | ✓ | ✓ | ✓ | ✓ | ✓ | |
| | — | — | — | ✓ | ✓ | ✓ | ✓ | ✓ | ✓ | ✓ | ✓ | |
| | — | — | — | ✓ | ✓ | ✓ | ✓ | ✓ | ✓ | ✓ | ✓ | |
| | IP20 ✓ | IP67 — | — | ✓ | ✓ | ✓ | ✓ | ✓ | ✓ | ✓ | ✓ | |
| | IP20 ✓ | IP67 — | — | ✓ | ✓ | ✓ | ✓ | ✓ | ✓ | ✓ | ✓ | |
| | ✓ | ✓ | ✓ | ✓ | ✓ | ✓ | ✓ | ✓ | ✓ | ✓ | ✓ | |
| | ✓ | ✓ | ✓ | ✓ | ✓ | ✓ | ✓ | ✓ | ✓ | ✓ | ✓ | |
| | — | — | — | — | — | ✓ | — | — | — | — | — | |
| | — | — | — | — | — | ✓ | — | — | — | — | — | |
| | — | — | — | ✓ | — | ✓ | IP20 ✓ | IP65 — | — | ✓ | — | ✓ |
| | — | — | — | ✓ | ✓ | ✓ | ✓ | — | — | — | ✓ | |
| | ✓ | — | — | ✓ | ✓ | ✓ | ✓ | ✓ | ✓ | ✓ | ✓ | |
| | ✓ | — | — | ✓ | ✓ | ✓ | ✓ | ✓ | ✓ | ✓ | ✓ | |
| | — | — | — | ✓ | — | ✓ | ✓ | — | — | ✓ | ✓ | |
| | — | — | — | ✓ | — | ✓ | ✓ | — | — | ✓ | ✓ | |
| | — | — | — | — | ✓ | — | IP20 ✓ | IP65 — | — | — | — | ✓ |
| | 12mm ✓ | 20mm — | 12mm — | 20mm ✓ | 12mm ✓ | 20mm ✓ | 12mm ✓ | 20mm ✓ | 12mm ✓ | 20mm ✓ | 12mm ✓ | 20mm ✓ |
| | — | — | — | ✓ | ✓ | ✓ | ✓ | ✓ | ✓ | — | ✓ | |
| | ✓ | — | — | ✓ | ✓ | ✓ | ✓ | ✓ | ✓ | ✓ | ✓ | |
| | ✓ | — | — | ✓ | ✓ | ✓ | ✓ | ✓ | ✓ | ✓ | ✓ | |
| | ✓ | ✓ | ✓ | ✓ | ✓ | ✓ | ✓ | ✓ | ✓ | ✓ | ✓ | |

Recommended Wiring

| FINE | 5 mts | 10 mts | 15 mts | 20 mts | 25 mts |
|-----------|---------|---------|---------|---------|--------|
| FINE 84 | 0,35 mm | 0,35 mm | 0,5 mm | 0,75 mm | 1 mm |
| FINE 69 | 0,2 mm | 0,2 mm | 0,35 mm | 0,5 mm | – |
| FINE 51 | 0,5 mm | 0,75 mm | 1 mm | – | – |
| FINE 49 | 0,35 mm | – | – | – | – |
| FINE 31 | 0,2 mm | 0,35 mm | – | – | – |
| FINE 44 | 0,5 mm | 0,75 mm | – | – | – |
| FINE 41 | 0,5 mm | 0,75 mm | 0,75 mm | 1 mm | – |
| FINE 61 | 0,35 mm | 0,5 mm | – | – | – |
| FINE 32 N | 0,5 mm | 0,5 mm | 0,5 mm | 0,5 mm | 0,5 mm |
| FINE 52 | 0,5 mm | 0,5 mm | – | – | – |
| FINE 56 | 0,35 mm | 0,5 mm | – | – | – |
| FINE 55 | 0,35 mm | – | – | – | – |
| FINE 36 | 0,5 mm | 0,5 mm | 0,75 mm | – | – |
| FINE 42 | 0,35 mm | 0,5 mm | – | – | – |
| FINE 50 | 0,35 mm | – | – | – | – |
| FINE 46 | 0,5 mm | 0,75 mm | 0,75 mm | 1 mm | – |
| FINE 43 | 0,35 mm | – | – | – | – |
| FINE 47 | 0,35 mm | – | – | – | – |
| FINE 66 | 0,5 mm | – | – | – | – |
| FINE 45 | 0,35 mm | 0,5 mm | 0,75 mm | – | – |

*Cable section.

Light Perception

| FINE | Open Circuit | | | | | Back Feed | | | | |
|-----------|--------------|--------|--------|--------|--------|-----------|--------|--------|--------|--------|
| | 5 mts | 10 mts | 15 mts | 20 mts | 25 mts | 5 mts | 10 mts | 15 mts | 20 mts | 25 mts |
| FINE 84 | 100% | 100% | 90% | 90% | 80% | 100% | 100% | 100% | 95% | 95% |
| FINE 69 | 98% | 73% | – | – | – | 100% | 88% | 70% | 63% | – |
| FINE 51 | 100% | 80% | 80% | – | – | 100% | 95% | 90% | – | – |
| FINE 49 | 90% | – | – | – | – | 100% | – | – | – | – |
| FINE 31 | 95% | – | – | – | – | 95% | 95% | – | – | – |
| FINE 44 | 94% | 72% | – | – | – | 98% | 94% | – | – | – |
| FINE 41 | 94% | 72% | 55% | – | – | 96% | 94% | 79% | 72% | – |
| FINE 61 | 100% | – | – | – | – | 100% | 100% | – | – | – |
| FINE 32 N | 100% | 100% | 90% | 90% | 80% | – | – | – | – | – |
| FINE 52 | 100% | – | – | – | – | 100% | 100% | – | – | – |
| FINE 56 | 98% | 80% | – | – | – | 100% | 95% | – | – | – |
| FINE 55 | 94% | 72% | – | – | – | 98% | 94% | – | – | – |
| FINE 36 | 90% | 66% | – | – | – | 95% | 90% | 76% | – | – |
| FINE 42 | 98% | 78% | – | – | – | 100% | 93% | – | – | – |
| FINE 50 | 95% | – | – | – | – | 100% | – | – | – | – |
| FINE 46 | 94% | 72% | 55% | – | – | 96% | 94% | 79% | 72% | – |
| FINE 43 | 100% | – | – | – | – | 100% | – | – | – | – |
| FINE 47 | 100% | – | – | – | – | 100% | – | – | – | – |
| FINE 66 | 98% | – | – | – | – | 100% | – | – | – | – |
| FINE 45 | 95% | 75% | 55% | – | – | 96% | 94% | 85% | – | – |

*Efficiency (%).

Open Circuit



Back Feed

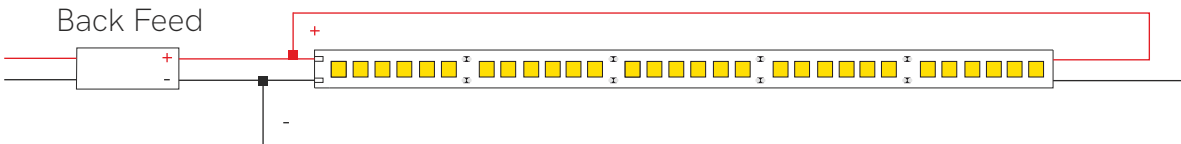

Technical lighting

179. Sono
183. Zoom
185. Lena
187. Aston
189. Konic
191. Kom
193. Tram track
195. Alfa
197. Picolo
204. Three phase
track accessories
209. Nox
211. Bonn
213. Tram recessed
217. Pulcom
225. Pulsar
233. Oxo
243. Tao



Sono 40W

Sono 60W

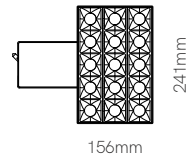
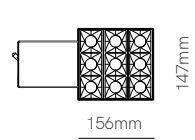
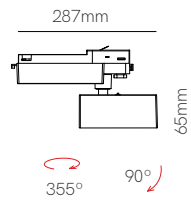
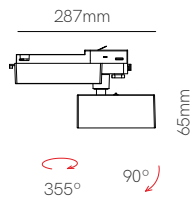

*Need Tuya Smart App to work.

Technical Information

| Version | Sono 40W | Sono 60W |
|-------------------|--|--|
| Power | 40W | 60W |
| Installation | Three Phase Track | Three Phase Track |
| Color Temperature | Tuya 2.600K - 4.000K | Tuya 2.600K - 4.000K |
| Lumens | 3.130 lm | 4.390 lm |
| Material | Aluminium and polycarbonate | Aluminium and polycarbonate |
| Finishes | White / Black | White / Black |
| Code | 4946 <input type="checkbox"/> 4947 <input type="checkbox"/> | 4950 <input type="checkbox"/> 4951 <input type="checkbox"/> |

Accessories

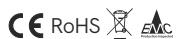

*See page 8 for Gateway additional info.

3 YEARS WARRANTY | 30.000 HOURS | IP 20 | 220/240 VAC | UGR <19 | PF >0,9 | CRI ≥98 | 30° | 50/60 Hz | IK06 | +45°C / -15°C | tuya | 1/4







Zoom



15° - 55°

Power and CTT switch

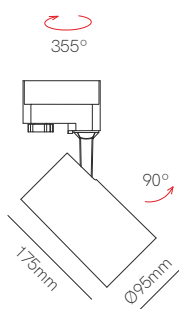

Technical Information

| | |
|-------------------|--|
| Version | Zoom |
| Power | Switch 15W / 20W / 25W |
| Installation | Three Phase Track |
| Color Temperature | Switch 2.700K / 3.200K / 4.000K |
| Lumens | 15W: 1.200 lm / 20W: 1.500lm / 25W: 1.800 lm |
| Material | Aluminium and polycarbonate |
| Finishes | White / Black |
| Code | 4900 <input type="checkbox"/> |
| | 4901 <input checked="" type="checkbox"/> |

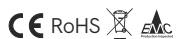

3 YEARS WARRANTY | 30.000 HOURS | IP 20 | 220/240 VAC | UGR <19 | PF >0,9 | CRI ≥90 | 15° - 55° | 50/60 Hz | IK06 | +45°C / -20°C | CCT SWITCH | POWER SWITCH | 1/10



Lena

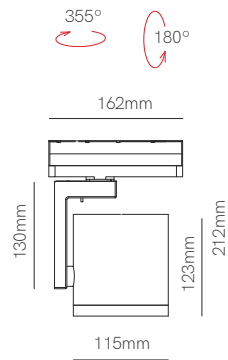

Technical Information

| | |
|-------------------|---|
| Version | Lena |
| Power | 35W |
| Installation | Three Phase Track |
| Color Temperature | Switch 2.700K / 3.200K / 4.000K |
| Lumens | 4.200 lm |
| Material | Aluminium |
| Finishes | White / Black |
| Code | 4449-V2 <input type="checkbox"/> |
| | 4450-V2 <input checked="" type="checkbox"/> |

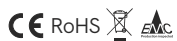

3 YEARS WARRANTY | 30.000 HOURS | IP 20 | 220/240 VAC | PF >0,9 | CRI ≥80 | 15° 38° 60° | 50/60 Hz | +50°C -20°C | CCT SWITCH | 1/8



Aston

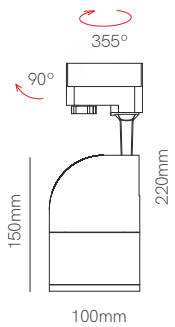

Technical Information

| | |
|-------------------|--|
| Version | Aston |
| Power | 20W |
| Installation | Three Phase Track |
| Color Temperature | Switch 2.700K / 3.200K / 4.000K |
| Lumens | 2.400 lm |
| Material | Aluminium |
| Finishes | White / Black |
| Code | 4439 <input type="checkbox"/> |
| | 4440 <input checked="" type="checkbox"/> |

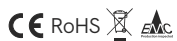

3 YEARS WARRANTY | 30.000 HOURS | IP 20 | 220/240 VAC | UGR <19 | PF >0,9 | CRI ≥80 | 15° 38° 60° | 50/60 Hz | +40°C -15°C | CCT SWITCH | AKZO NOBEL | 1/8



New

Konic

Konic dimmable

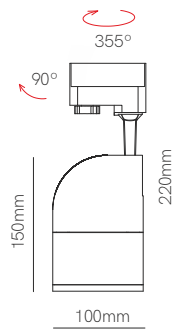
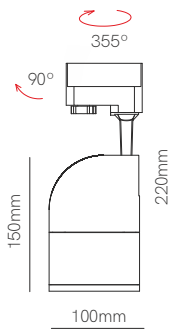

Technical Information

| | | |
|-------------------|---|---|
| Version | Konic | Konic dimmable |
| Power | 30W | 30W |
| Installation | Three Phase Track | Three Phase Track |
| Color Temperature | Switch 2.700K / 3.200K / 4.000K | Switch 2.700K / 3.200K / 4.000K |
| Lumens | 2.440 lm | 2.440 lm |
| Material | Aluminium | Aluminium |
| Finishes | White / Black | White / Black |
| Code | 4441-N <input type="checkbox"/> 4442-N <input checked="" type="checkbox"/> | 4985 <input type="checkbox"/> 4986 <input checked="" type="checkbox"/> |

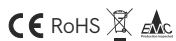

3 YEARS WARRANTY | 30.000 HOURS | IP 20 | 220/240 VAC | UGR <19 | PF >0,9 | CRI ≥94 | 15° 38° 60° | 50/60 Hz | +40°C -15°C | CCT SWITCH | AKZO NOBEL | 1/8



Kom 20W

Kom 30W

Kom 40W

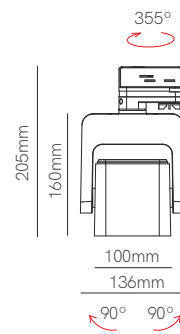
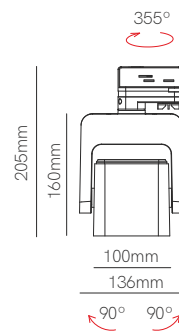
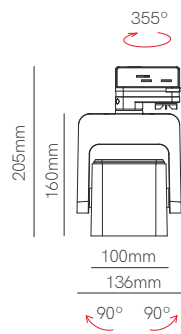

Technical Information

| Version | Kom 20W | Kom 30W | Kom 40W |
|-------------------|---|---|--|
| Power | 20W | 30W | 40W |
| Installation | Three Phase Track | Three Phase Track | Three Phase Track |
| Color Temperature | Switch 2.700K / 3.200K / 4.000K | Switch 2.700K / 3.200K / 4.000K | 3.000K / 4.000K |
| Lumens | 2.300 lm | 2.470 lm | 4.500 lm / 4.600 lm |
| Material | Aluminium | Aluminium | Aluminium |
| Finishes | White / Black | White / Black | White / Black |
| Code | 4337 <input type="checkbox"/> 4339 <input checked="" type="checkbox"/> | 4336-N <input type="checkbox"/> 4338-N <input checked="" type="checkbox"/> | 4444 <input type="checkbox"/> 3.000K 4445 <input type="checkbox"/> 4.000K 4447 <input checked="" type="checkbox"/> 3.000K 4448 <input checked="" type="checkbox"/> 4.000K |

CRI ≥80 | CCT SWITCH

CRI ≥94 | CCT SWITCH

CRI ≥80



3 YEARS WARRANTY | 30.000 HOURS | IP 20 | 220/240 VAC | UGR <19 | PF >0,9 | 15° 24° 40° | 50/60 Hz | +50°C -20°C | AKZO NOBEL | 1/10



Tram 20W



Tram 30W

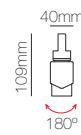
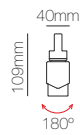
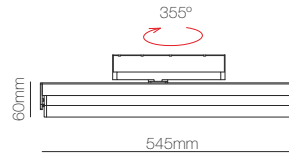
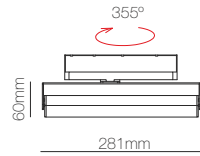

Technical Information

| | | |
|-------------------|---------------------|---------------------|
| Version | Tram 20W | Tram 30W |
| Power | 20W | 30W |
| Installation | Three Phase Track | Three Phase Track |
| Color Temperature | 3.000K / 4.000K | 3.000K / 4.000K |
| Lumens | 2.320 lm / 2.400 lm | 3.520 lm / 3.600 lm |
| Material | Aluminium | Aluminium |
| Finishes | White / Black | White / Black |

| | | |
|------|---|---|
| Code | 4427 <input type="checkbox"/> 3.000K | 4541 <input type="checkbox"/> 3.000K |
| | 4428 <input type="checkbox"/> 4.000K | 4542 <input type="checkbox"/> 4.000K |
| | 4429 <input checked="" type="checkbox"/> 3.000K | 4543 <input checked="" type="checkbox"/> 3.000K |
| | 4430 <input checked="" type="checkbox"/> 4.000K | 4544 <input checked="" type="checkbox"/> 4.000K |

5 YEARS WARRANTY

3 YEARS WARRANTY



30.000 HOURS | IP 20 | 220/240 VAC | UGR <19 | PF >0,9 | CRI ≥80 | 45° | 50/60 Hz | +45°C / -20°C | 1/10



Alfa

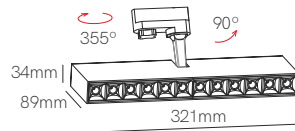

Technical Information

| | |
|-------------------|--------------------------------|
| Version | Alfa |
| Power | 32W |
| Installation | Three Phase Track |
| Color Temperature | 2.700K / 3.000K / 4.000K |
| Lumens | 3.100 lm / 3.200 lm / 3.250 lm |
| Material | Aluminium |
| Finishes | White / Black |

| | | | |
|------|------|-------------------------------------|--------|
| Code | 4038 | <input type="checkbox"/> | 2.700K |
| | 4039 | <input type="checkbox"/> | 3.000K |
| | 4040 | <input type="checkbox"/> | 4.000K |
| | 4176 | <input checked="" type="checkbox"/> | 2.700K |
| | 4177 | <input checked="" type="checkbox"/> | 3.000K |
| | 4178 | <input checked="" type="checkbox"/> | 4.000K |

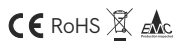

5 YEARS WARRANTY | 30.000 HOURS | IP 20 | 220/240 VAC | UGR <19 | PF >0,9 | CRI ≥80 | 45° | 50/60 Hz | +40°C / -10°C | AKZO NOBEL | 1/10



Piccolo

Piccolo base

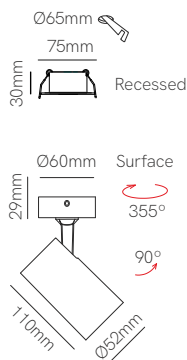
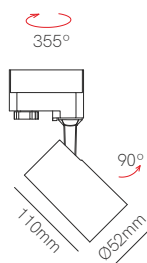

Technical Information

| | | |
|-------------------|--|--|
| Version | Piccolo | Piccolo base |
| Power | 9,5W | 9,5W |
| Installation | Three Phase Track | Surface / Recessed |
| Color Temperature | Switch 2.700K / 3.200K / 4.000K | Switch 2.700K / 3.200K / 4.000K |
| Lumens | 1.300 lm | 1.300 lm |
| Material | Aluminium | Aluminium |
| Finishes | White / Black | White / Black |
| Code | 4437 <input type="checkbox"/> | 4833 <input type="checkbox"/> |
| | 4438 <input checked="" type="checkbox"/> | 4834 <input checked="" type="checkbox"/> |

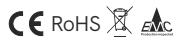

*Surface and recessed base included with Piccolo base.

3 YEARS WARRANTY | 30.000 HOURS | IP 20 | 220/240 VAC | UGR <19 | PF >0,9 | CRI ≥80 | 15° 38° 60° | 50/60 Hz | +50°C -20°C | CCT SWITCH | AKZO NOBEL | 1/20

Piccolo GU10 track V3

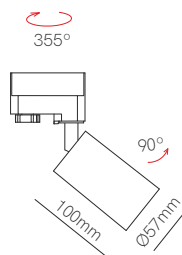

Technical Information

| | |
|--------------|---|
| Version | Piccolo GU10 track V3 |
| Installation | Three Phase Track |
| Material | Aluminium |
| Finishes | White / Black |
| Code | 3990-V3 <input type="checkbox"/> |
| | 3989-V3 <input checked="" type="checkbox"/> |



*GU10 bulbholder included.

3 YEARS WARRANTY | IP 20 | 220/240 VAC | AKZO NOBEL |  | 



Piccolo GU10 track



Piccolo GU10 base

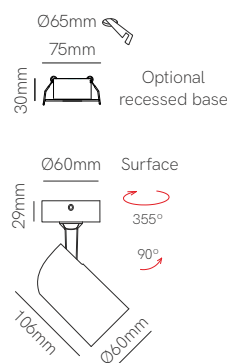
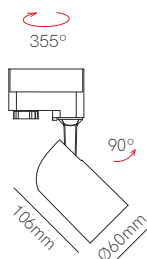

Technical Information

| | | |
|--------------|---|--|
| Version | Piccolo GU10 track | Piccolo GU10 base |
| Installation | Three Phase Track | Surface / Recessed |
| Material | Aluminium | Aluminium |
| Finishes | White / Black | White / Black |
| Code | 3990-V2 <input type="checkbox"/> | 4050 <input type="checkbox"/> |
| | 3989-V2 <input checked="" type="checkbox"/> | 4049 <input checked="" type="checkbox"/> |

Accessories



*GU10 bulbholder included.

5 YEARS WARRANTY | IP 20 | 220/240 VAC | AKZO NOBEL | | 1/40



Piccolo AR11 track

Piccolo AR111 base

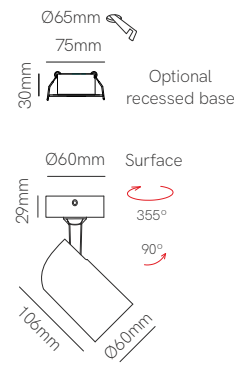
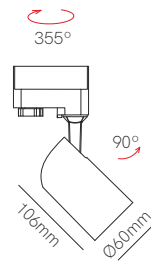

Technical Information

| | | |
|--------------|-------------------------------|-------------------------------|
| Version | Piccolo AR111 track | Piccolo AR111 base |
| Installation | Three Phase Track | Surface / Recessed |
| Material | Aluminium | Aluminium |
| Finishes | White / Black | White / Black |
| Code | 4435 <input type="checkbox"/> | 4433 <input type="checkbox"/> |

Accessories



*GU10 bulbholder included.

5 YEARS WARRANTY | IP 20 | 220/240 VAC | AKZO NOBEL | | 1/40



Three phase track surface accessories

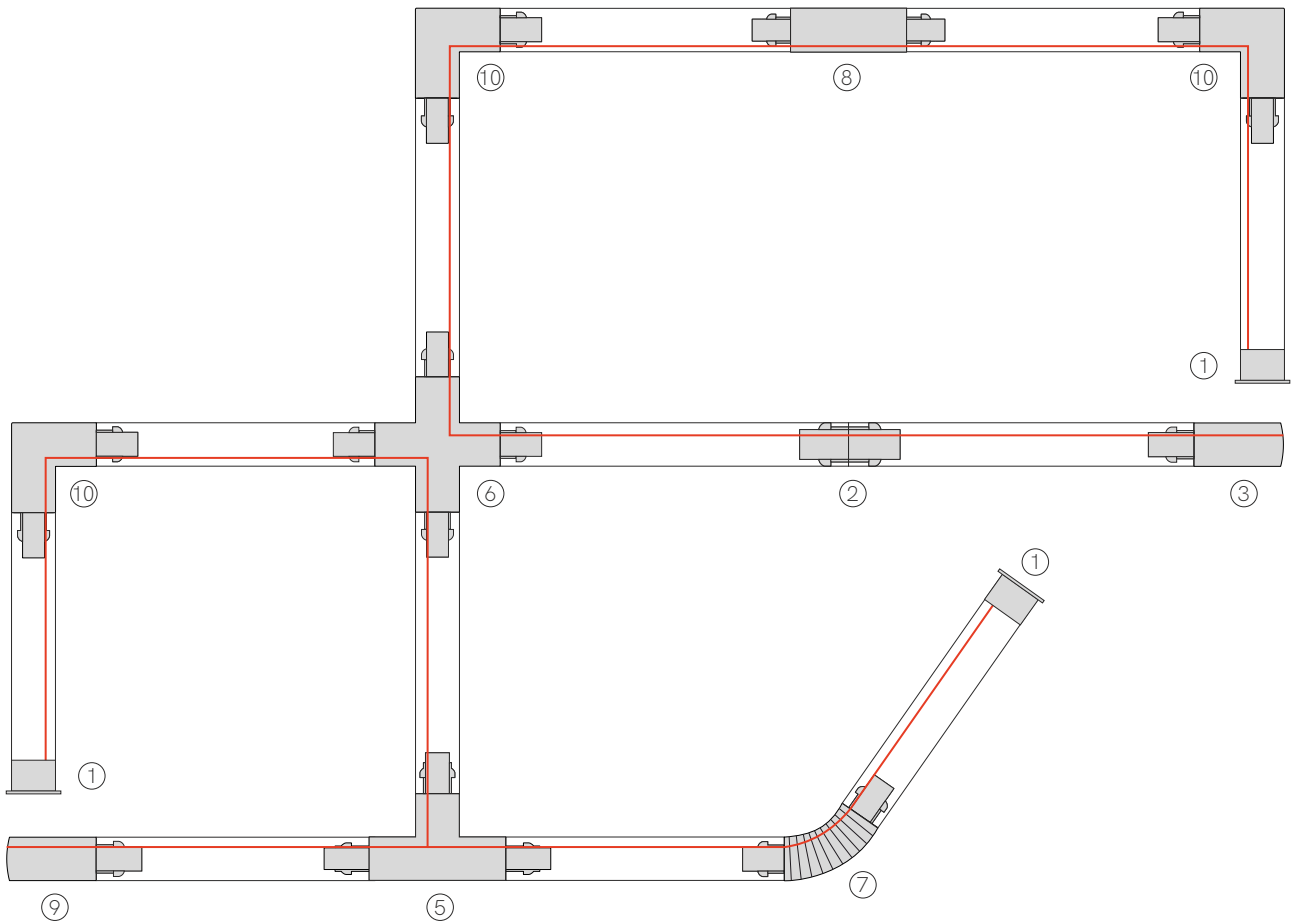
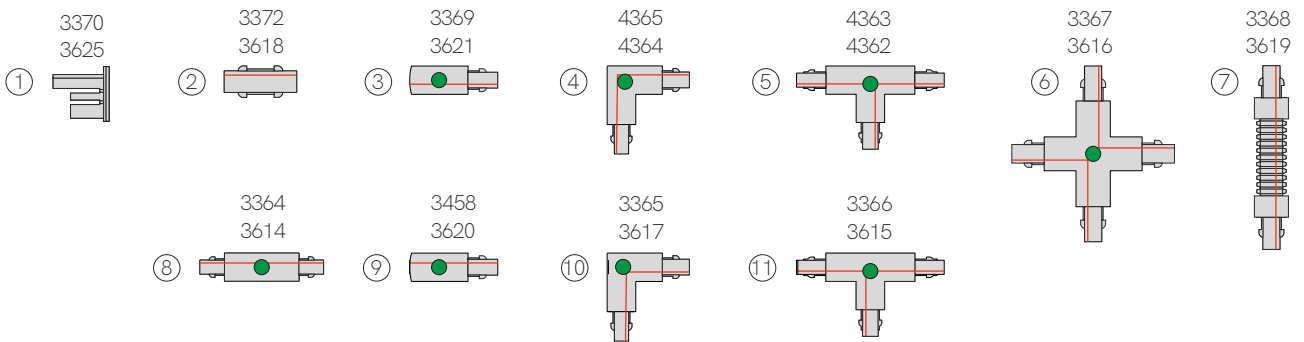

● Allows power input



3 YEARS WARRANTY | IP 20



*End cap and power supply included

Three phase track surface

L: 32mm H: 31mm

3795 1m

3796 2m

3797 3m

D-3626 1m

D-3627 2m

D-3628 3m



Track ceiling surface

L: 30mm W: 25mm H: 12mm

3373

3623



Track power supply surface

L: 98mm W: 32mm H: 32mm

3369 Left

3458 Right

3621 Left

3620 Right

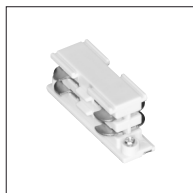

Joint track without spacing

L: 68mm W: 25mm H: 27mm

3372

3618

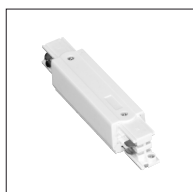

Joint track with spacing surface

L: 166mm W: 35mm H: 32mm

3364

3614



Flexible joint track

L: 245mm W: 35mm H: 32mm

3368

3619

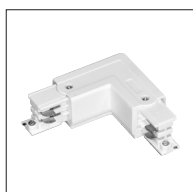

L Joint track surface

L: 100mm W: 66mm H: 32mm

4365 Left

3365 Right

4364 Left

3617 Right



T Joint track surface

L: 166mm W: 100mm H: 32mm

4363 Left

3366 Right

4362 Left

3615 Right

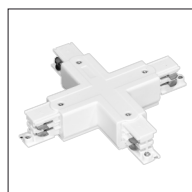

X Joint track surface

L: 166mm W: 166mm H: 32mm

3367

3616



End cap

L: 32mm W: 32mm H: 32mm

3370

3625



Three phase adapter

L: 70mm W: 40mm H: 41mm

3371-V2

3624-V2



Suspension kit

L: 3.000mm W: Ø35 | Ø2.4 H: 47mm

3459

3622



Three phase surface base

L: Ø100mm H: 32mm

4700

4701



Three phase track recessed accessories

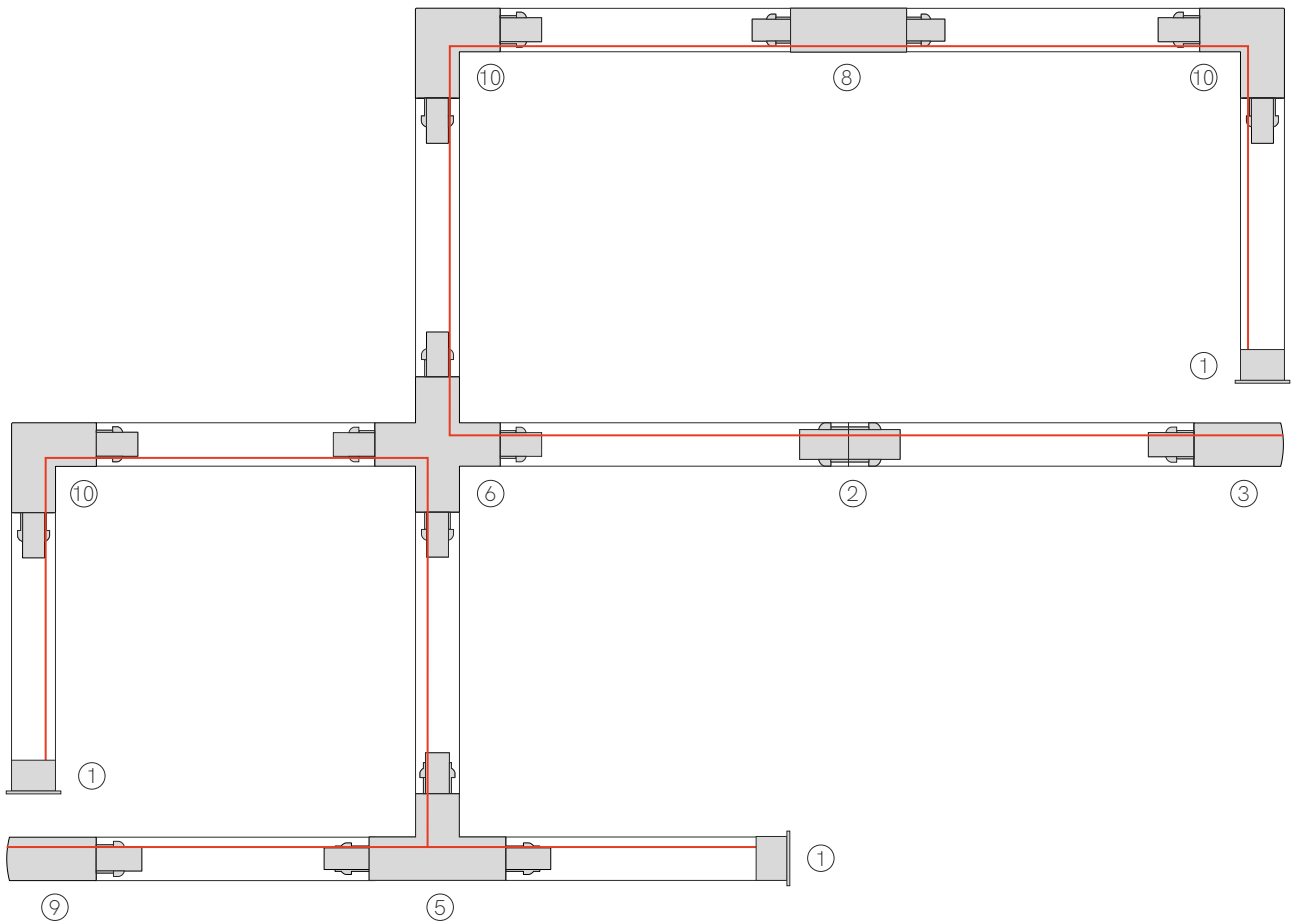
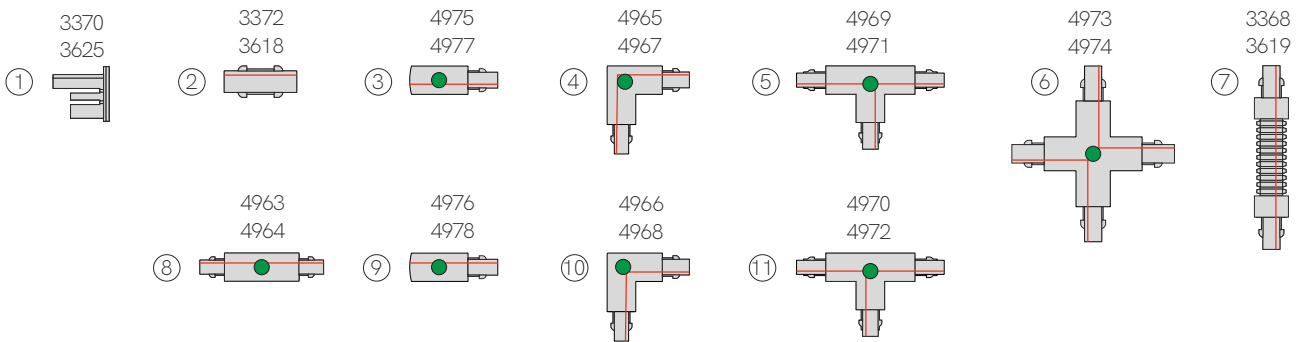

● Allows power input



3 YEARS WARRANTY | IP 20



Three phase track recessed

L: 56mm H: 33mm

3897 2m

3898 3m

4753 2m

4754 3m

*End cap and power supply included

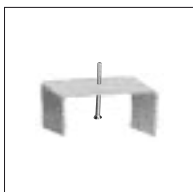

Track ceiling recessed

L: 64mm W: 25mm H: 32mm

3805



Track power supply Recessed New

L: 98mm W: 56,5mm H: 33,7mm

4975 Left

4976 Right

4977 Left

4978 Right

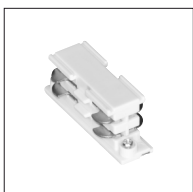

Joint Track Without Spacing

L: 68mm W: 25mm H: 27mm

3372

3618

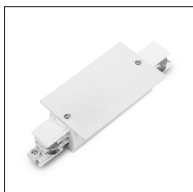

Joint track with spacing recessed New

L: 166mm W: 56,5mm H: 33,7mm

4963

4964



Flexible joint track

L: 245mm W: 35mm H: 32mm

3368

3619



L Joint track recessed New

L: 111mm W: 111mm H: 33,7mm

4965 Left

4966 Right

4967 Left

4968 Right

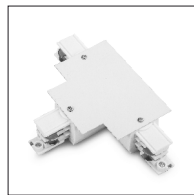

T Joint track recessed New

L: 166mm W: 111mm H: 33,7mm

4969 Left

4970 Right

4971 Left

4972 Right

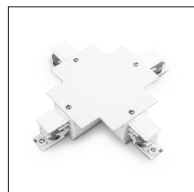

X Joint track recessed New

L: 166mm W: 166mm H: 33,7mm

4973

4974



End cap

L: 32mm W: 32mm H: 32mm

3370

3625



Three phase adapter

L: 70mm W: 40mm H: 41mm

3371-V2

3624-V2

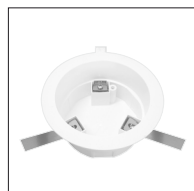

Three phase recessed base

L: Ø130mm H: 60mm Ø110mm

3851

3852

*Need Three Phase Surface Base (4700 or 4701) to put inside.





Nox

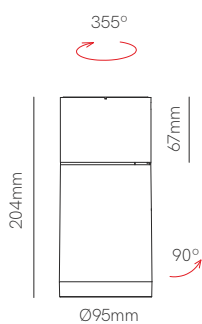

Technical Information

| | |
|-------------------|---------------------------------|
| Version | Nox |
| Power | 30W |
| Installation | Surface |
| Color Temperature | Switch 2.700K / 3.200K / 4.000K |
| Lumens | 2.460 lm |
| Material | Aluminium |
| Finishes | White / Black |

| | |
|------|--|
| Code | 4241-N <input type="checkbox"/> |
| | 4242-N <input checked="" type="checkbox"/> |

Accessories



Included with:
4241-N



Included with:
4241-N / 4242-N

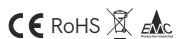

3 YEARS WARRANTY | 30.000 HOURS | IP 20 | 220/240 VAC | UGR <19 | PF >0,9 | CRI ≥94 | 15° / 24° / 40° | 50/60 Hz | +50°C / -20°C | CCT SWITCH | 1/8



Bonn

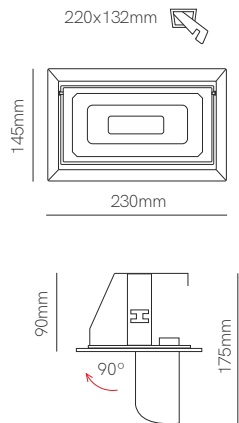

Technical Information

| | |
|-------------------|---------------------|
| Version | Bonn |
| Power | 40W |
| Installation | Recessed |
| Color Temperature | 3.000K / 4.100K |
| Lumens | 4.750 lm / 4.800 lm |
| Material | Aluminium |
| Finishes | White / Gray |

| | |
|------|---|
| Code | 4097 <input type="checkbox"/> 3.000K |
| | 4096 <input type="checkbox"/> 4.100K |
| | 4099 <input checked="" type="checkbox"/> 3.000K |
| | 4098 <input checked="" type="checkbox"/> 4.100K |



5 YEARS WARRANTY | 30.000 HOURS | IP 20 | 220/240 VAC | PF >0,9 | CRI ≥80 | 100° | 50/60 Hz | | +40°C / -20°C | | 1/12



Tram recessed 2

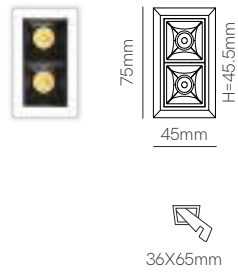

Tram recessed 5

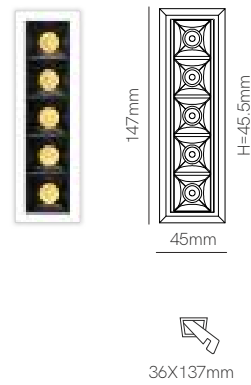

*Need Tuya Smart App to work.

Technical Information

| | | |
|-------------------|--|--|
| Version | Tram recessed 2 | Tram recessed 5 |
| Power | 6W | 10W |
| Installation | Recessed | Recessed |
| Color Temperature | Tuya 2.700K - 6.000K | Tuya 2.700K - 6.000K |
| Lumens | 220 lm | 500 lm |
| Material | Aluminium | Aluminium |
| Finishes | White / Black | White / Black |
| Code | 4731 <input type="checkbox"/> | 4733 <input type="checkbox"/> |
| | 4732 <input checked="" type="checkbox"/> | 4734 <input checked="" type="checkbox"/> |
| | | |

Accessories

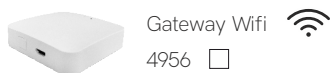

*See page 8 for Gateway additional info.



Tram recessed 10

Tram recessed 15

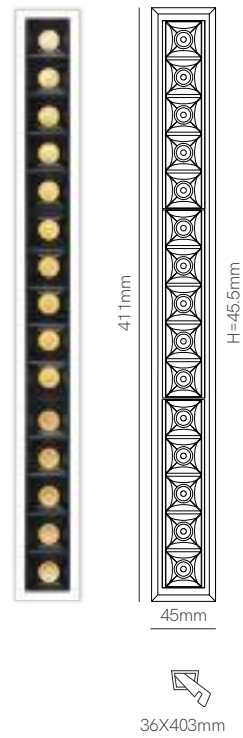
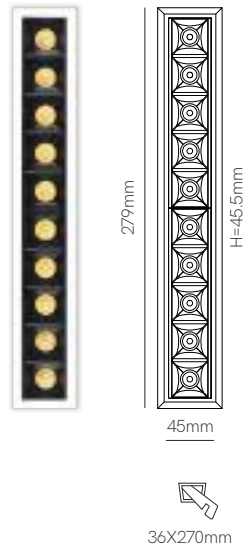

*Need Tuya Smart App to work.

Technical Information

| | | |
|-------------------|--|--|
| Version | Tram recessed 10 | Tram recessed 15 |
| Power | 20W | 30W |
| Installation | Recessed | Recessed |
| Color Temperature | Tuya 2.700K - 6.000K | Tuya 2.700K -6.000K |
| Lumens | 1.000 lm | 1.500 lm |
| Material | Aluminium | Aluminium |
| Finishes | White / Black | White / Black |
| Code | 4735 <input type="checkbox"/> 4736 <input type="checkbox"/> | 4737 <input type="checkbox"/> 4738 <input type="checkbox"/> |



Accessories



*See page 8 for Gateway additional info.







Pulcom round

Pulcom square

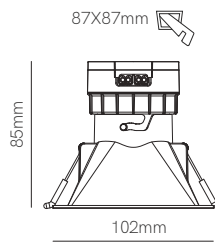
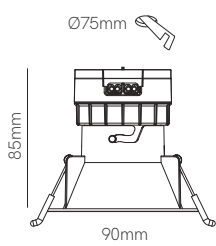

Technical Information

| Version | Pulcom round | Pulcom square |
|-------------------|---|---|
| Power | 8W | 8W |
| Installation | Recessed | Recessed |
| Color Temperature | Switch 2.700K / 3.200K / 4.000K | Switch 2.700K / 3.200K / 4.000K |
| Lumens | 800 lm | 800 lm |
| Material | Polycarbonate | Polycarbonate |
| Finishes | White / Black | White / Black |
| Code | 4742 <input type="checkbox"/> 4746 <input checked="" type="checkbox"/> | 4744 <input type="checkbox"/> 4748 <input checked="" type="checkbox"/> |

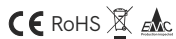

3 YEARS WARRANTY | 25.000 HOURS | IP 44 | 220/240 VAC | UGR <19 | PF >0,9 | CRI ≥80 | 38° | 50/60 Hz | IK06 | +40°C / -20°C | CCT SWITCH | 1/5/20

Pulcom round asymmetric

Pulcom square asymmetric

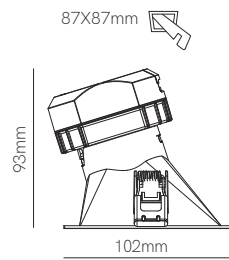
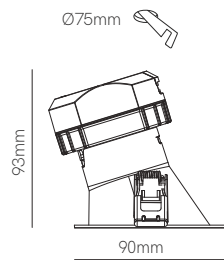

Technical Information

| | | |
|-------------------|---|---|
| Version | Pulcom round asymmetric | Pulcom square asymmetric |
| Power | 8W | 8W |
| Installation | Recessed | Recessed |
| Color Temperature | Switch 2.700K / 3.200K / 4.000K | Switch 2.700K / 3.200K / 4.000K |
| Lumens | 800 lm | 800 lm |
| Material | Polycarbonate | Polycarbonate |
| Finishes | White / Black | White / Black |
| Code | 4743 <input type="checkbox"/> 4747 <input checked="" type="checkbox"/> | 4745 <input type="checkbox"/> 4749 <input checked="" type="checkbox"/> |

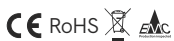

3 YEARS WARRANTY | 25.000 HOURS | IP 44 | 220/240 VAC | UGR <19 | PF >0,9 | CRI ≥80 | 38° | 50/60 Hz | IK06 | +40°C / -20°C | CCT SWITCH | 1/5/20



Pulcom led

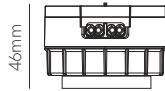

Pulcom trim



Round trim

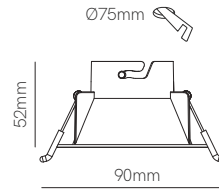

Pulcom asymmetric trim



Asymmetric round trim

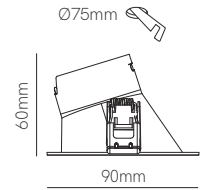

Square trim

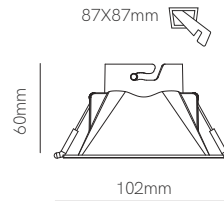

Asymmetric square trim

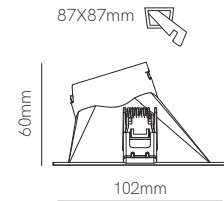

Technical Information

| Version | Pulcom led | Pulcom trim | Pulcom asymmetric trim |
|-------------------|--|--|--|
| Power | 8W | - | - |
| Installation | Recessed | Recessed | Recessed |
| Color Temperature | Switch 2.700K / 3.200K / 4.000K | - | - |
| Lumens | 800 lm | - | - |
| Material | Polycarbonate | Polycarbonate | Polycarbonate |
| Finishes | White / Black | White / Black / Wood | White / Black |
| Code | 4763 <input type="checkbox"/> | 4761 <input type="checkbox"/> round | 4821 <input type="checkbox"/> round asymmetric |
| | 4764 <input checked="" type="checkbox"/> | 4762 <input checked="" type="checkbox"/> round | 4822 <input checked="" type="checkbox"/> round asymmetric |
| | | 4935 <input checked="" type="checkbox"/> round Wood New | 4825 <input type="checkbox"/> square asymmetric |
| | | 4823 <input type="checkbox"/> square | 4826 <input checked="" type="checkbox"/> square asymmetric |
| | | 4824 <input checked="" type="checkbox"/> square | |



3 YEARS WARRANTY | 25.000 HOURS | IP 44 | 220/240 VAC | UGR <19 | PF >0,9 | CRI ≥80 | 38° | 50/60 Hz | IK06 | +40°C / -20°C | CCT SWITCH | 1/5/20



New

Pulcom surface accessory

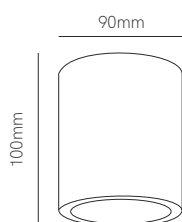

Technical Information

| | |
|--------------|--|
| Version | Pulcom surface accessory |
| Installation | Surface |
| Material | Polycarbonate |
| Finishes | White / Black / Wood |
| Code | 5034 <input type="checkbox"/> |
| | 5035 <input checked="" type="checkbox"/> |
| | 5036 <input type="checkbox"/> Wood |

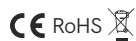

*Need Pulcom led (page 220).







Private Residence, Granollers (Spain). Construction: ABL Group. Design: Mon Arquitectura.

New

Pulsar switch

Pulsar

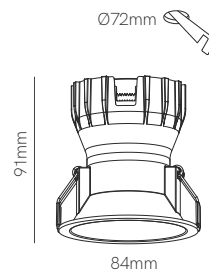
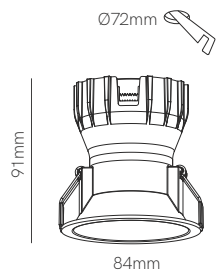

Technical Information

| | | |
|-------------------|--|---|
| Version | Pulsar switch | Pulsar |
| Power | 8W | 8W |
| Installation | Recessed | Recessed |
| Color Temperature | Switch 2.700K / 3.200K / 4.000K | 2.700K / 3.000K / 4.000K / 5.000K |
| Lumens | 780 lm / 800 lm / 840 lm | 780 lm / 800 lm / 840 lm / 860 lm |
| Material | Aluminium | Aluminium |
| Finishes | White / Black | White / Black |
| Code | 5057 <input type="checkbox"/> | 4198 <input type="checkbox"/> 2.700K |
| | 5058 <input checked="" type="checkbox"/> | 4199 <input type="checkbox"/> 3.000K |
| | | 4200 <input type="checkbox"/> 4.000K |
| | | 4217 <input type="checkbox"/> 5.000K |
| | | 4201 <input checked="" type="checkbox"/> 2.700K |
| | | 4202 <input checked="" type="checkbox"/> 3.000K |
| | | 4203 <input checked="" type="checkbox"/> 4.000K |
| | | 4218 <input checked="" type="checkbox"/> 5.000K |

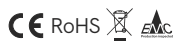

3 YEARS WARRANTY | 30.000 HOURS | IP 65 | 220/240 VAC | UGR <16 | PF >0,9 | CRI ≥85 | 40° | 50/60 Hz | TRIAC DIMM | RT 2012 REGLEMENTATION THERMIQUE | +45°C / -20°C | 1/10/30

New

Pulsar surface accessory

Pulsar asymmetric trim

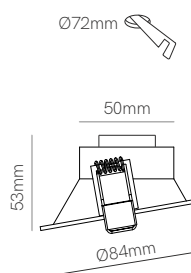
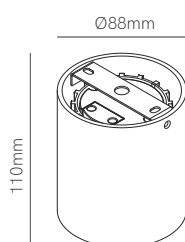

Technical Information

| | | |
|--------------|---|---|
| Version | Pulsar surface accessory | Pulsar asymmetric trim |
| Installation | Surface | Recessed |
| Material | Aluminium | Aluminium |
| Finishes | White / Black | White / Black |
| Code | 5110 <input type="checkbox"/> 5111 <input checked="" type="checkbox"/> | 5059 <input type="checkbox"/> 5060 <input checked="" type="checkbox"/> |

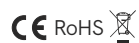

*Need Pulsar (page 225).





Nano pulsar round

Nano pulsar square

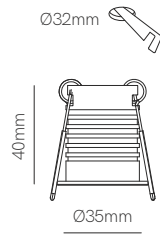

Technical Information

| Version | Nano pulsar round | Nano pulsar square |
|-------------------|---|---|
| Power | 3,5W | 3,5W |
| Installation | Recessed | Recessed |
| Color Temperature | 2.700K / 3.000K / 4.000K | 2.700K / 3.000K / 4.000K |
| Lumens | 170 lm / 180 lm / 200 lm | 170 lm / 180 lm / 200 lm |
| Material | Aluminium | Aluminium |
| Finishes | White / Black | White / Black |
| Code | 4297 <input type="checkbox"/> 2.700K 4298 <input type="checkbox"/> 3.000K 4299 <input type="checkbox"/> 4.000K 4300 <input checked="" type="checkbox"/> 2.700K 4301 <input checked="" type="checkbox"/> 3.000K 4302 <input checked="" type="checkbox"/> 4.000K | 4451 <input type="checkbox"/> 2.700K 4452 <input type="checkbox"/> 3.000K 4453 <input type="checkbox"/> 4.000K 4454 <input checked="" type="checkbox"/> 2.700K 4455 <input checked="" type="checkbox"/> 3.000K 4456 <input checked="" type="checkbox"/> 4.000K |



3 YEARS WARRANTY | 30.000 HOURS | IP 65 | 220/240 VAC | UGR <16 | PF >0,5 | CRI ≥80 | 30° | 50/60 Hz | | +40°C / -20°C | | | 1/50



Nano pulsar round surface accessory

Nano pulsar square surface accessory



*Not included

*Not included

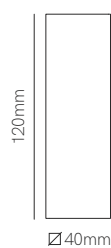
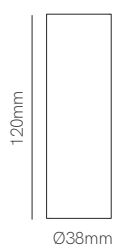

Technical Information

| | | |
|--------------|--|--|
| Version | Nano pulsar round surface accessory | Nano pulsar square surface accessory |
| Installation | Surface | Surface |
| Material | Aluminium | Aluminium |
| Finishes | White / Black | White / Black |
| Code | 4410 <input type="checkbox"/> 4411 <input type="checkbox"/> | 4412 <input type="checkbox"/> 4413 <input type="checkbox"/> |

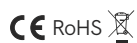

*Need Nano Pulsar (page 228).







Oxo round

Oxo square

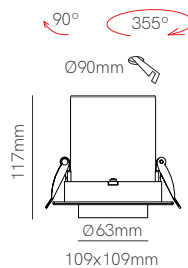
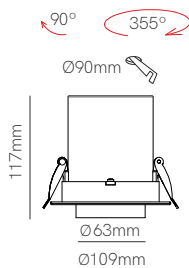
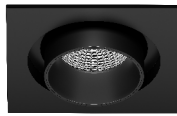

Technical Information

| | | |
|-------------------|--|--|
| Version | Oxo round | Oxo square |
| Power | 12W | 12W |
| Installation | Recessed | Recessed |
| Color Temperature | Switch 2.700K / 3.200K / 4.000K | Switch 2.700K / 3.200K / 4.000K |
| Lumens | 1.260 lm | 1.260 lm |
| Material | Aluminium | Aluminium |
| Finishes | White / Black | White / Black |
| Code | 4457 <input type="checkbox"/> 4458 <input type="checkbox"/> | 4459 <input type="checkbox"/> 4460 <input type="checkbox"/> |

Accessories



Included with:
4457 / 4459



Included with:
4457 / 4458 / 4459 / 4460

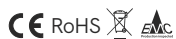

3 YEARS WARRANTY | 30.000 HOURS | IP 20 | 220/240 VAC | UGR <14 | PF >0,9 | CRI ≥80 |
 15° / 38° / 60° | 50/60 Hz |
 CCT SWITCH | +50°C / -20°C |
 1/20





New

Mini oxo round 1

Mini oxo square 1



Ø80mm 

Ø80mm 

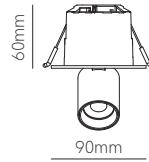
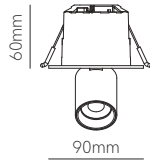

Technical Information

| Version | Mini oxo round 1 | Mini oxo square 1 |
|-------------------|---|---|
| Power | 6W | 6W |
| Installation | Recessed | Recessed |
| Color Temperature | Switch 2.700K / 3.200K / 4.000K | Switch 2.700K / 3.200K / 4.000K |
| Lumens | 600 | 600 |
| Material | Polycarbonate | Polycarbonate |
| Finishes | White / Black | White / Black |
| Code | 5061 <input type="checkbox"/> 5062 <input checked="" type="checkbox"/> | 5108 <input type="checkbox"/> 5109 <input checked="" type="checkbox"/> |

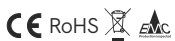

3 YEARS WARRANTY | 25.000 HOURS | IP 20 | 100/277 VAC | UGR <19 | PF >0,9 | CRI ≥80 |  | 42°  | 50/60 Hz |  |  +40°C / -20°C | CCT SWITCH  | 1/20

New

Mini oxo square 2

Mini oxo square 4

Mini oxo square 6



130X80mm

227X80mm

325X80mm

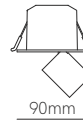
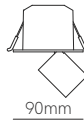
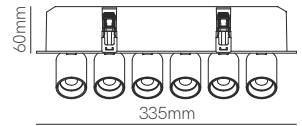
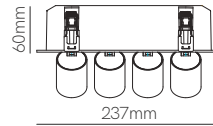
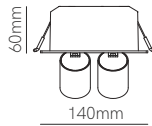

Technical Information

| Version | Mini oxo square 2 | Mini oxo square 4 | Mini oxo square 6 |
|-------------------|---|---|---|
| Power | 12W | 24W | 36W |
| Installation | Recessed | Recessed | Recessed |
| Color Temperature | Switch 2.700K / 3.200K / 4.000K | Switch 2.700K / 3.200K / 4.000K | Switch 2.700K / 3.200K / 4.000K |
| Lumens | 1.200 | 2.400 | 3.600 |
| Material | Polycarbonate | Polycarbonate | Polycarbonate |
| Finishes | White / Black | White / Black | White / Black |
| Code | 5063 <input type="checkbox"/> 5064 <input checked="" type="checkbox"/> | 5065 <input type="checkbox"/> 5066 <input checked="" type="checkbox"/> | 5067 <input type="checkbox"/> 5068 <input checked="" type="checkbox"/> |



3 YEARS WARRANTY | 25.000 HOURS | IP 20 | 100/277 VAC | UGR <19 | PF >0,9 | CRI ≥80 | | 42° | 50/60 Hz | | +40°C / -20°C | CCT SWITCH





Nano oxo round

Nano oxo square

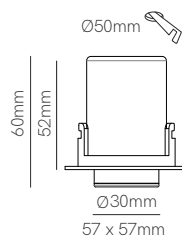
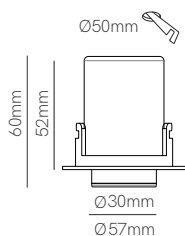

Technical Information

| Version | Nano oxo round | Nano oxo square |
|-------------------|---|---|
| Power | 4W | 4W |
| Installation | Recessed | Recessed |
| Color Temperature | Switch 2.700K / 3.200K / 4.000K | Switch 2.700K / 3.200K / 4.000K |
| Lumens | 380 lm | 380 lm |
| Material | Aluminium | Aluminium |
| Finishes | White / Black | White / Black |
| Code | 4549 <input type="checkbox"/> 4551 <input checked="" type="checkbox"/> | 4550 <input type="checkbox"/> 4552 <input checked="" type="checkbox"/> |

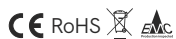

3 YEARS WARRANTY | 30.000 HOURS | IP 20 | 220/240 VAC | UGR <19 | PF >0,5 | CRI ≥90 | 45° | 50/60 Hz | | +50°C / -20°C | CCT SWITCH | | 1/10/50





Tao

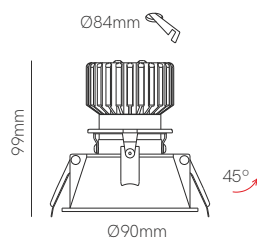

Technical Information

| | |
|-------------------|--|
| Version | Tao |
| Power | 10W |
| Installation | Recessed |
| Color Temperature | 3.000K / 4.000K |
| Lumens | 925 lm / 1.000 lm |
| Material | Aluminium |
| Finishes | White / Black |
| Code | 3942 <input type="checkbox"/> 3.000K 3943 <input type="checkbox"/> 4.000K 3944 <input checked="" type="checkbox"/> 3.000K 3945 <input checked="" type="checkbox"/> 4.000K |

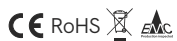

3 YEARS WARRANTY | 50.000 HOURS | IP 32 | 220/240 VAC | UGR <19 | PF >0,9 | CRI ≥80 | 38° | 50/60 Hz | | +40°C / -20°C | | 1/40

Decorative lighting

- 249. Tram 48V
- 251. Line 48V
- 253. Cookie 48V
- 257. Dot 48V
- 259. Bora 48V
- 261. Alp 48V
- 265. Zoe 48V
- 269. Volt 48V
- 270. Magnet track
- accessories
- 272. Space
- 276. Side base
- 278. Front base
- 281. Bora
- 285. Zoe
- 290. Alp
- 294. Lievo
- 299. Bora
- 305. Zoe
- 307. Atmos
- 313. Ark
- 315. Volt
- 321. Tot
- 323. Rubyc
- 327. Concord
- 331. Plus
- 335. Mac wall
- 339. One wall
- 341. Zio wall
- 345. Icon
- 347. Sweet
- 351. Beam
- 353. Pure
- 355. Lao
- 357. Pun
- 359. Ilo, Skin
- 360. Port, Grow, Steps
- 363. Stem
- 365. Lievo
- 367. Converse lighting

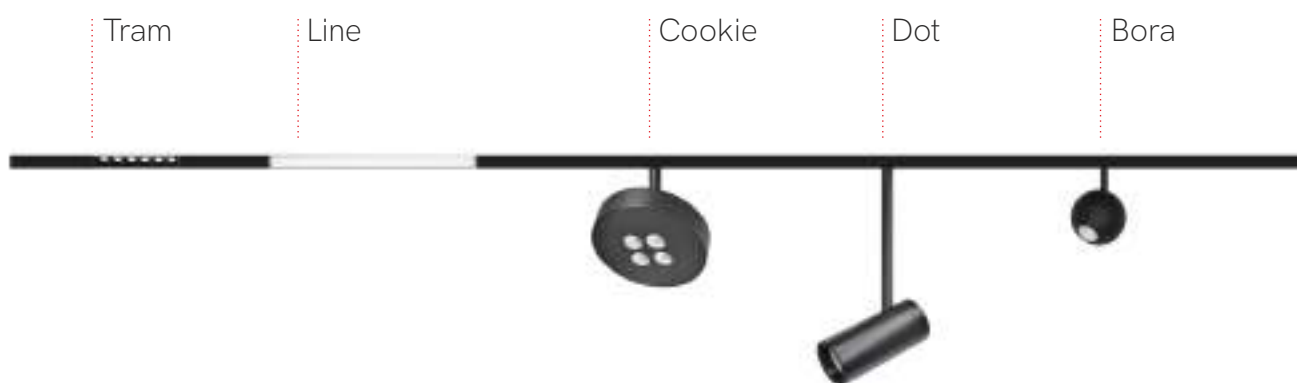

48V Magnet Track

Beneito Faure extends the range of tracks by incorporating the 48V version. The use of 48V wall lights provides a more minimalist and elegant lighting effect.

Beneito Faure amplía la gama de carriles incorporando la versión de 48V. El uso de apliques 48V proporciona un efecto más minimalista y elegante de la luz.

Bora
Suspension

Alp

Alp
Suspension

Zoe

Volt

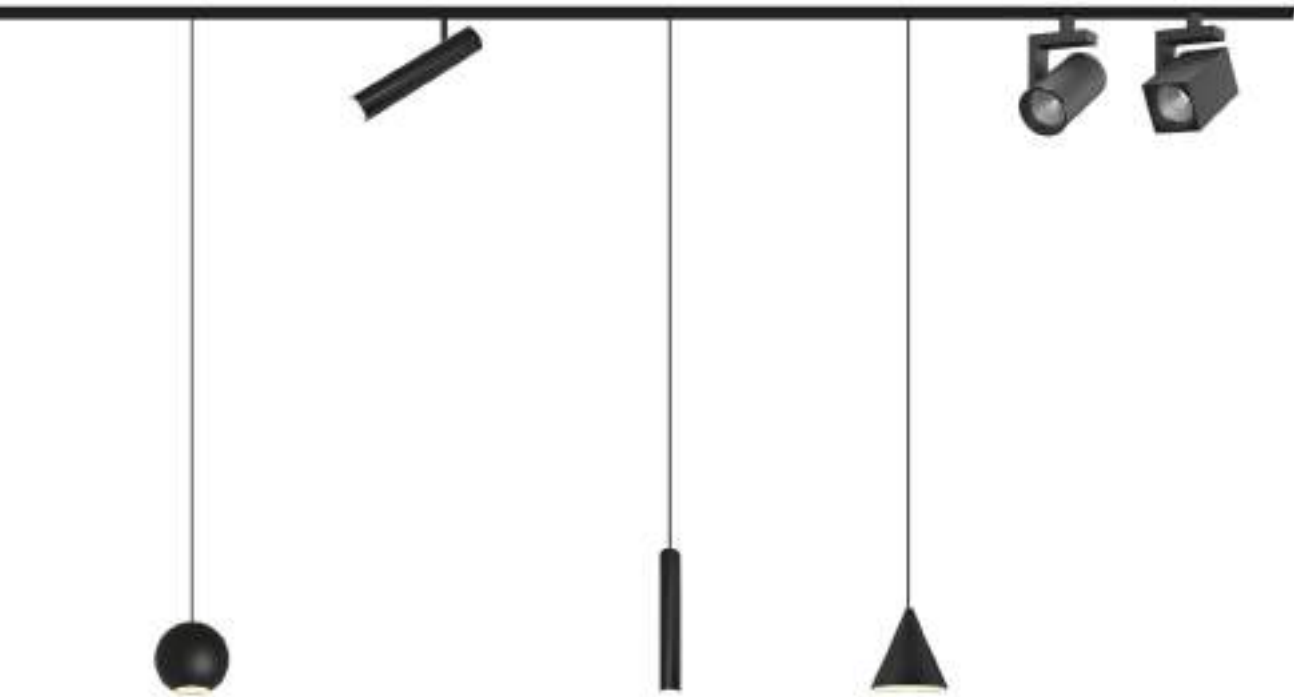



Tram 48V 4,5W



Tram 48V 9W

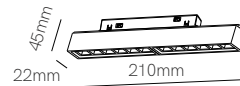
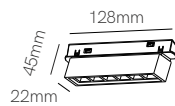

Technical Information

| Version | Tram 48V 4,5W | Tram 48V 9W |
|-------------------|-----------------|-----------------|
| Power | 4,5W | 9W |
| Installation | Magnet Track | Magnet Track |
| Color Temperature | 2.700K / 3.000K | 2.700K / 3.000K |
| Lumens | 300 lm / 310 lm | 690 lm / 710 lm |
| Material | Aluminium | Aluminium |
| Finishes | White / Black | White / Black |

| Code | 4776 <input type="checkbox"/> 2.700K | 4777 <input type="checkbox"/> 3.000K | 4778 <input checked="" type="checkbox"/> 2.700K | 4779 <input checked="" type="checkbox"/> 3.000K | 4780 <input type="checkbox"/> 2.700K | 4781 <input type="checkbox"/> 3.000K | 4782 <input checked="" type="checkbox"/> 2.700K | 4783 <input checked="" type="checkbox"/> 3.000K |
|------|--------------------------------------|--------------------------------------|---|---|--------------------------------------|--------------------------------------|---|---|
|------|--------------------------------------|--------------------------------------|---|---|--------------------------------------|--------------------------------------|---|---|

PF >0,4

PF >0,5

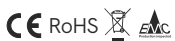

*Need power supply (page 270).

3 YEARS WARRANTY |
 26.000 HOURS |
 IP 20 |
 48V DC |
 UGR <19 |
 CRI ≥90 |
 III |
 24° |
 50/60 Hz |
 +40°C / -20°C |
 1/50



Line 48V 7,5W

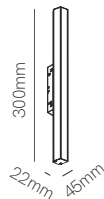

Line 48V 15W

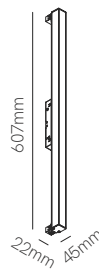

Line 48V 30W

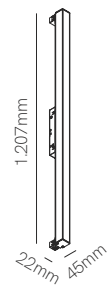

Technical Information

| | | | |
|-------------------|--------------|--------------|--------------|
| Version | Line 7,5W | Line 15W | Line 30W |
| Power | 7,5W | 15W | 30W |
| Installation | Magnet Track | Magnet Track | Magnet Track |
| Color Temperature | 3.000K | 3.000K | 3.000K |
| Lumens | 320 lm | 760 lm | 1.050 lm |
| Material | Aluminium | Aluminium | Aluminium |
| Finishes | Black | Black | Black |
| Code | 4784 ■ | 4785 ■ | 4786 ■ |

1/25 | PF >0,4

1/25 | PF >0,5

1/20 | PF >0,5



*Need power supply (page 270).

3 YEARS WARRANTY | 26.000 HOURS | IP 20 | 48V DC | UGR <19 | CRI ≥90 | III | 100° | 50/60 Hz | +40°C / -20°C



Cookie 48V

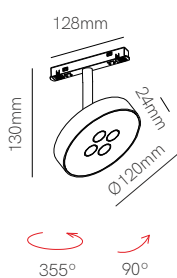

Technical Information

| | |
|-------------------|-----------------|
| Version | Cookie |
| Power | 12W |
| Installation | Magnet Track |
| Color Temperature | 2.700K / 3.000K |
| Lumens | 940 lm / 950 lm |
| Material | Aluminium |
| Finishes | White / Black |

| | | | |
|------|------|-------------------------------------|--------|
| Code | 4772 | <input type="checkbox"/> | 2.700K |
| | 4773 | <input type="checkbox"/> | 3.000K |
| | 4774 | <input checked="" type="checkbox"/> | 2.700K |
| | 4775 | <input checked="" type="checkbox"/> | 3.000K |

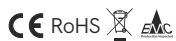

*Need power supply (page 270).

3 YEARS WARRANTY | 26.000 HOURS | IP 20 | 48V DC | UGR <19 | PF >0,5 | CRI ≥90 | III | 38° | 50/60 Hz | +40°C / -20°C | 1/20







Dot 48V

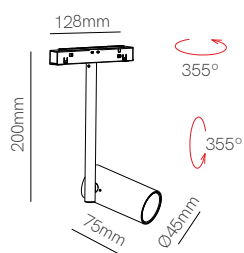

Technical Information

| | |
|-------------------|-----------------|
| Version | Dot |
| Power | 11W |
| Installation | Magnet Track |
| Color Temperature | 2.700K / 3.000K |
| Lumens | 680 lm / 690 lm |
| Material | Aluminium |
| Finishes | White / Black |

| | | | |
|------|------|-------------------------------------|--------|
| Code | 4768 | <input type="checkbox"/> | 2.700K |
| | 4769 | <input type="checkbox"/> | 3.000K |
| | 4770 | <input checked="" type="checkbox"/> | 2.700K |
| | 4771 | <input checked="" type="checkbox"/> | 3.000K |

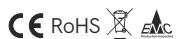

*Need power supply (page 270).

3 YEARS WARRANTY | 26.000 HOURS | IP 20 | 48V DC | UGR <19 | PF >0,5 | CRI ≥90 | III | 35° | 50/60 Hz | +40°C / -20°C | 1/20



Bora 48V

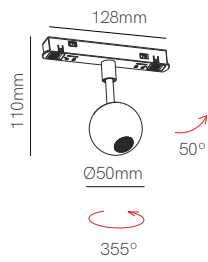

Bora 48V suspension

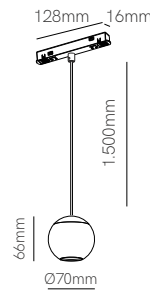

Technical Information

| | | |
|-------------------|------------------------------------|-----------------------------------|
| Version | Bora 48V | Bora 48V suspension |
| Power | 4,5W | 8,5W |
| Installation | Magnet Track | Magnet Track |
| Color Temperature | 2.700K / 3.000K | 2.700K / 3.000K |
| Lumens | 315 lm / 325 lm | 610 lm / 620 lm |
| Material | Aluminium | Aluminium |
| Finishes | White / Black / Chrome / Rose gold | White / Back / Chrome / Rose gold |

| | | |
|------|---|---|
| Code | 4581 <input type="checkbox"/> 2.700K | 4573 <input type="checkbox"/> 2.700K |
| | 4582 <input type="checkbox"/> 3.000K | 4574 <input type="checkbox"/> 3.000K |
| | 4583 <input checked="" type="checkbox"/> 2.700K | 4575 <input checked="" type="checkbox"/> 2.700K |
| | 4584 <input checked="" type="checkbox"/> 3.000K | 4576 <input checked="" type="checkbox"/> 3.000K |
| | 4585 <input type="checkbox"/> 2.700K | 4577 <input type="checkbox"/> 2.700K |
| | 4586 <input type="checkbox"/> 3.000K | 4578 <input type="checkbox"/> 3.000K |
| | 4587 <input type="checkbox"/> 2.700K | 4579 <input type="checkbox"/> 2.700K |
| | 4588 <input type="checkbox"/> 3.000K | 4580 <input type="checkbox"/> 3.000K |

UGR <10 | 38°

UGR <15 | 36°

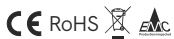

*Need power supply (page 270).

3 YEARS WARRANTY | 26.000 HOURS | IP 20 | 48V DC | PF >0,4 | CRI ≥93 | | 50/60 Hz | +40°C / -20°C |



Alp 48V



Alp suspension 48V

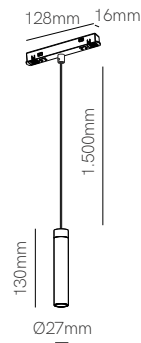
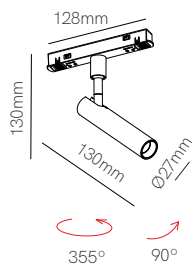

Technical Information

| | | |
|-------------------|-----------------|-----------------|
| Version | Alp | Alp suspension |
| Power | 4,5W | 4,5W |
| Installation | Magnet Track | Magnet Track |
| Color Temperature | 2.700K / 3.000K | 2.700K / 3.000K |
| Lumens | 260 lm / 270 lm | 260 lm / 270 lm |
| Material | Aluminium | Aluminium |
| Finishes | White / Black | White / Black |

| | | |
|------|---|---|
| Code | 4787 <input type="checkbox"/> 2.700K | 4791 <input type="checkbox"/> 2.700K |
| | 4788 <input type="checkbox"/> 3.000K | 4792 <input type="checkbox"/> 3.000K |
| | 4789 <input checked="" type="checkbox"/> 2.700K | 4793 <input checked="" type="checkbox"/> 2.700K |
| | 4790 <input checked="" type="checkbox"/> 3.000K | 4794 <input checked="" type="checkbox"/> 3.000K |

1/20

1/25



*Need power supply (page 270).

3 YEARS WARRANTY | 26.000 HOURS | IP 20 | 48V DC | UGR <19 | PF >0,4 | CRI ≥90 | III | 38° | 50/60 Hz | +40°C / -20°C







Zoe 48V

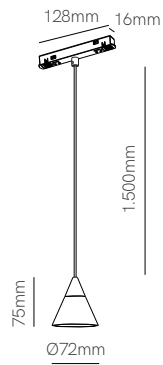

Technical Information

| | |
|-------------------|-----------------|
| Version | Zoe 48V |
| Power | 7W |
| Installation | Magnet Track |
| Color Temperature | 2.700K / 3.000K |
| Lumens | 360 lm / 370 lm |
| Material | Aluminium |
| Finishes | White / Black |

| | | | |
|------|------|-------------------------------------|--------|
| Code | 4795 | <input type="checkbox"/> | 2.700K |
| | 4796 | <input type="checkbox"/> | 3.000K |
| | 4797 | <input checked="" type="checkbox"/> | 2.700K |
| | 4798 | <input checked="" type="checkbox"/> | 3.000K |



*Need power supply (page 270).

3 YEARS WARRANTY | 26.000 HOURS | IP 20 | 48V DC | UGR <19 | PF >0,5 | CRI ≥90 | III | 38° | 50/60 Hz | +40°C / -20°C | | 1/36







New

Volt round 48V

Volt square 48V

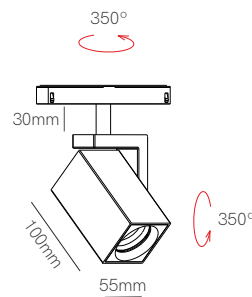
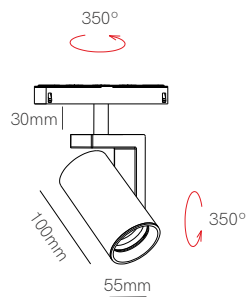

Technical Information

| | | |
|-------------------|---|---|
| Version | Volt round 48V | Volt square 48V |
| Power | 8W | 8W |
| Installation | Magnet Track | Magnet Track |
| Color Temperature | Dali 2.700K - 4.000K | Dali 2.700K - 4.000K |
| Lumens | 570 lm | 570 lm |
| Material | Aluminium | Aluminium |
| Finishes | White / Black | White / Black |
| Code | 5037 <input type="checkbox"/> 5038 <input checked="" type="checkbox"/> | 5039 <input type="checkbox"/> 5040 <input checked="" type="checkbox"/> |

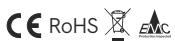

*Need power supply (page 270).

3 YEARS WARRANTY | 30.000 HOURS | IP 20 | 48V DC | PF >0,9 | CRI ≥90 | | 38° | IK06 | 50/60 Hz | +45°C / -20°C | | | 1/20

Magnet track accessories

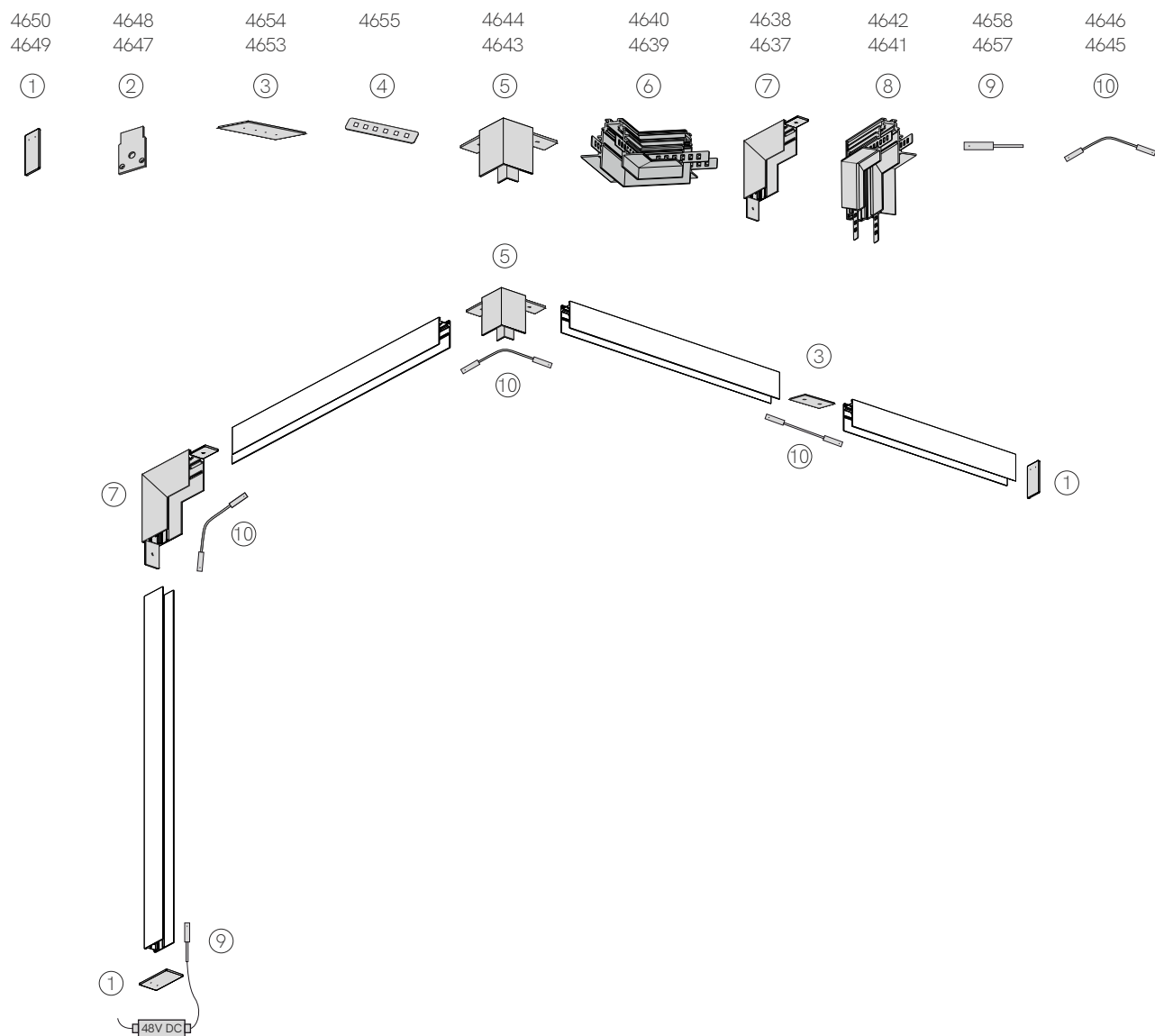

Power Supplies 48V

| Code | Version | Power | IP | VDC OUT | Size |
|------|--------------------------------|-------|------|---------|-------------|
| 4711 | ■ Power Supply Basic | 60W | IP67 | 48 VDC | 150x53x36mm |
| 4707 | ■ Power Supply Top | 150W | IP65 | 48 VDC | 219x63x35mm |
| 4708 | ■ Power Supply Top | 240W | IP65 | 48 VDC | 244x71x37mm |
| 5139 | ■ New Power Supply Dali | 90W | IP67 | 48 VDC | 171x63x38mm |
| 5140 | ■ New Power Supply Dali | 200W | IP67 | 48 VDC | 191x68x40mm |

5 YEARS WARRANTY | 100-240 VAC | Basic Dali | Top | PF >0,9



Magnet Track surface

W: 26mm H: 53mm

4660 1m

4662 2m

4659 1m

4661 2m

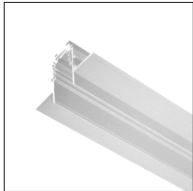

Magnet track recessed

W: 72mm x H: 55mm

4664 1m

4666 2m

4663 1m

4665 2m



End cap surface

L: 53mm W: 26.6mm H: 2mm

4650

4649



End cap recessed

L: 52mm W: 32mm H: 2mm

4648

4647

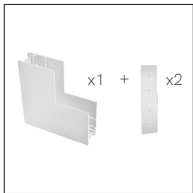

L joint wall ceiling surface

L: 100mm W: 100mm H: 26mm

4638

4637

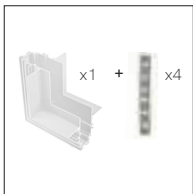

L joint wall ceiling recessed

L: 100mm W: 100mm H: 72mm

4642

4641

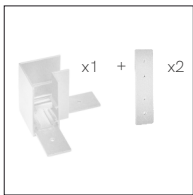

L joint ceiling surface

L: 40mm W: 40mm H: 53mm

4644

4643

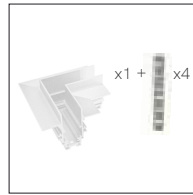

L joint ceiling recessed

L: 100mm W: 100mm H: 55mm

4640

4639

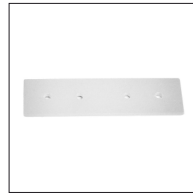

Linear joint surface

L: 80mm W: 22.5mm H: 2mm

4654

4653



Linear joint recessed

L: 70mm W: 11.5mm H: 1mm

4655



Start connector

L: 98mm W: 18mm H: 18mm

4658

4657



Central corner connector

L: 98mm W: 18mm H: 18mm

4646

4645



PVC trim

W: 26.8mm H: 3.5mm

4651 1m

4652 2m



Suspension kit

L: 45mm W: 22mm | Ø15mm H: 1.900mm

4807

Create your own design with **Space**

Space is a new lighting concept that seeks to be part of the design and finishes of a room. This lighting system creates an unlimited number of lines and compositions that are born out of a surface base. The final design is left to the user, who can select and customize the distribution of the luminaire in the space.

Space es un nuevo concepto de iluminación que busca formar parte del diseño y acabados de un espacio. Este sistema de iluminación crea trazos y composiciones ilimitadas que nacen de una base de superficie. El diseño final queda en manos del usuario, el cual puede escoger y personalizar como distribuye la luminaria a través del espacio.

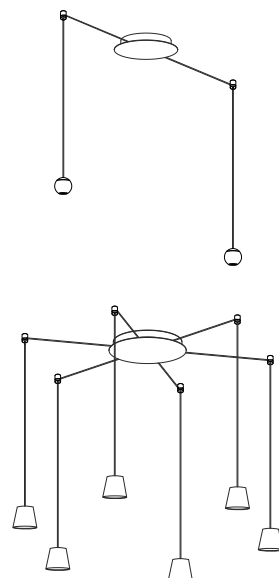

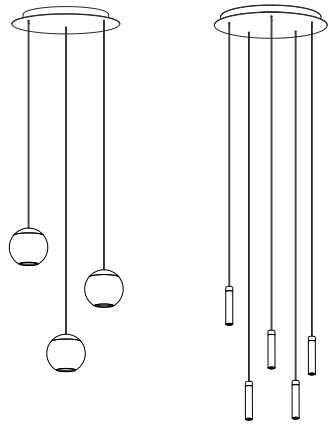

This innovative system allows you to create spectacular vertical suspended compositions by means of a unique and incomparable design. With our decorative spotlights it is possible to create entirely customizable light points at different heights. The Space system, supported by a thread up to six meters long, is compatible with Bora, Zoe, Lievo, Alp, Nano Alp, Bora XL, Zoe XL and Lievo XL decorative products. Choose the size of the base that best suits the composition among different diameters and create your own luminaire.

Este innovador sistema permite crear composiciones colgantes verticales espectaculares a través de un diseño único e irrepetible. Con nuestros spotlights decorativos es posible crear puntos de luz a distintas alturas totalmente personalizables. El sistema Space, sostenido por un hilo de hasta seis metros de largo, es compatible con los productos decorativos Bora, Zoe, Lievo, Alp, Nano Alp, Bora XL, Zoe XL y Lievo XL. Escoge el tamaño de la base que mejor se adapte a la composición entre distintos diámetros y crea tu propia luminaria.



The light points of the Space system can be moved away from the base and brought to any place desired through the wire holder. It is a piece that is mounted on the surface of the ceiling to support the conductor wire of the lighting structure. This system of hanging lamps gives total freedom to architects and interior designers to create repetitions of light that can compose from chaotic structures to the most symmetrical. If you have a false ceiling where the driver can rest, you can use the system with the individual recessed base, a great option for integrating the structure in an elegant way.

Los puntos de luz del sistema Space pueden alejarse de la base y llevarse a cualquier ubicación deseada a través del wire holder. Se trata de una pieza que se instala en la superficie del techo para sostener el hilo conductor de la estructura lumínica. Este sistema de lámparas colgantes ofrece una total libertad a arquitectos e interioristas para crear repeticiones de luz que pueden componer desde estructuras caóticas, hasta las más simétricas. En caso de contar con un falso techo donde pueda reposar el driver, puedes usar el sistema con la base individual de encastrar, una muy buena opción para integrar de forma elegante la estructura.

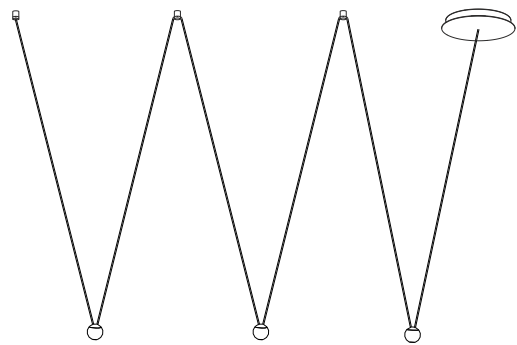



Side base New

Base Ø25x41mm

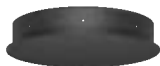

| Code | |
|------|-----------|
| Code | S1 |

| Product | | Units | |
|----------|----------|---------|----------|
| Bora | 1 | 2 units | 2 |
| Zoe | 3 | 3 units | 3 |
| Lievo | 5 | 4 units | 4 |
| Alp | 7 | 5 units | 5 |
| Nano Alp | 8 | 6 units | 6 |

| Driver | |
|----------|----------|
| On / Off | 1 |
| Dali | 2 |
| Triac | 3 |
| Casambi | 5 |

| Color | |
|---|----------|
| <input type="checkbox"/> White | 1 |
| <input checked="" type="checkbox"/> Black | 2 |

Code: **S1**

Base Ø28x41mm

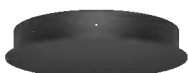

| Code | |
|------|-----------|
| Code | S2 |

| Product | | Units | |
|----------|----------|---------|----------|
| Bora | 1 | 2 units | 2 |
| Zoe | 3 | 3 units | 3 |
| Lievo | 5 | 4 units | 4 |
| Alp | 7 | 5 units | 5 |
| Nano Alp | 8 | 6 units | 6 |

| Driver | |
|----------|----------|
| On / Off | 1 |
| Dali | 2 |
| Triac | 3 |
| Casambi | 5 |

| Color | |
|---|----------|
| <input type="checkbox"/> White | 1 |
| <input checked="" type="checkbox"/> Black | 2 |

Code: **S2**

Base Ø33x41mm



| Code | |
|------|-----------|
| Code | S3 |

| Product | | Units | |
|----------|----------|---------|----------|
| Bora | 1 | 2 units | 2 |
| Bora XL | 2 | 3 units | 3 |
| Zoe | 3 | 4 units | 4 |
| Zoe XL | 4 | 5 units | 5 |
| Lievo | 5 | 6 units | 6 |
| Lievo XL | 6 | 7 units | 7 |
| Alp | 7 | 8 units | 8 |
| Nano Alp | 8 | | |

| Driver | |
|----------|----------|
| On / Off | 1 |
| Dali | 2 |
| Triac | 3 |
| Casambi | 5 |

| Color | |
|---|----------|
| <input type="checkbox"/> White | 1 |
| <input checked="" type="checkbox"/> Black | 2 |

Code: **S3**

Accessories



Wire holder
 5106
 5107



Additional wire (1m)
 5128
 5129



*Create your code according to your preferences. For other finishing please consult.





Front base New

Base Ø25x41mm



| Code | |
|------|-----------|
| Code | F1 |

| Product | Units |
|----------|-------|
| Bora | 1 |
| Zoe | 3 |
| Lievo | 5 |
| Alp | 7 |
| Nano Alp | 8 |

| Driver | Units |
|----------|-------|
| On / Off | 1 |
| Dali | 2 |
| Triac | 3 |
| Casambi | 5 |

| Color | Units |
|---|-------|
| <input type="checkbox"/> White | 1 |
| <input checked="" type="checkbox"/> Black | 2 |

Code: **F1**

Base Ø28x41mm



| Code | |
|------|-----------|
| Code | F2 |

| Product | Units |
|----------|-------|
| Bora | 1 |
| Zoe | 3 |
| Lievo | 5 |
| Alp | 7 |
| Nano Alp | 8 |

| Driver | Units |
|----------|-------|
| On / Off | 1 |
| Dali | 2 |
| Triac | 3 |
| Casambi | 5 |

| Color | Units |
|---|-------|
| <input type="checkbox"/> White | 1 |
| <input checked="" type="checkbox"/> Black | 2 |

Code: **F2**

Base Ø33x41mm



| Code | |
|------|-----------|
| Code | F3 |

| Product | Units |
|----------|---------|
| Bora | 1 |
| Zoe | 3 |
| Lievo | 5 |
| Alp | 7 |
| Nano Alp | 8 |
| | 7 units |
| | 8 units |

| Driver | Units |
|----------|-------|
| On / Off | 1 |
| Dali | 2 |
| Triac | 3 |
| Casambi | 5 |

| Color | Units |
|---|-------|
| <input type="checkbox"/> White | 1 |
| <input checked="" type="checkbox"/> Black | 2 |

Code: **F3**

Base Ø33x41mm



| Code | |
|------|-----------|
| Code | F3 |

| Product | Units |
|----------|-------|
| Bora XL | 2 |
| Zoe XL | 4 |
| Lievo XL | 6 |

| Driver | Units |
|----------|-------|
| On / Off | 1 |
| Dali | 2 |
| Triac | 3 |
| Casambi | 5 |

| Color | Units |
|---|-------|
| <input type="checkbox"/> White | 1 |
| <input checked="" type="checkbox"/> Black | 2 |

Code: **F3**

Accessories



Wire holder
 5106
 5107



Additional wire (1m)
 5128
 5129



*Create your code according to your preferences. For other finishing please consult.







Private Residence, Rubí (Spain). Design: Prêt-à-porter casas.

New

Bora suspension

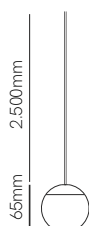

Technical Information

| | |
|-------------------|---------------------------------|
| Version | Bora suspension |
| Power | 8W |
| Installation | Surface / Recessed |
| Color Temperature | Switch 2.700K / 3.200K / 4.000K |
| Lumens | 570 lm |
| Material | Aluminium |
| Finishes | White / Black |
| Code | 5084 <input type="checkbox"/> |
| | 5085 <input type="checkbox"/> |

*Base not included. You need to choose a base to complete the installation.

Accessories

| | | | | |
|---|--|---|--|--|
|  |  |  |  |  |
| Surface Base 8W Ø75x33mm <input type="checkbox"/> 5118 <input type="checkbox"/> 5119 | Recessed Base 8W Ø90x22mm / Ø80mm <input type="checkbox"/> 5120 <input type="checkbox"/> 5121 | Wire holder <input type="checkbox"/> 5106 <input type="checkbox"/> 5107 | Additional wire (1m) <input type="checkbox"/> 5128 <input type="checkbox"/> 5129 | Side base / Front base Ø25 Side base / Front base Ø28 Side base / Front base Ø33 |

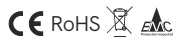

*See pages 276 and 278 for available codes of Side base and Front base.

3 YEARS WARRANTY |
 30.000 HOURS |
 IP 20 |
 100/277 VAC |
 UGR <19 |
 PF >0,9 |
 CRI ≥93 |
 38° |
 50/60 Hz |
 +45°C / -20°C |
 CCT SWITCH |
 1/20

New

Bora XL suspension

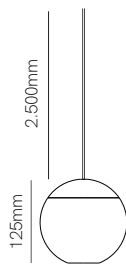

Technical Information

| | |
|-------------------|--|
| Version | Bora XL suspension |
| Power | 15W |
| Installation | Surface / Recessed |
| Color Temperature | Switch 2.700K / 3.200K / 4.000K |
| Lumens | 1.100 lm |
| Material | Aluminium |
| Finishes | White / Black |
| Code | 5086 <input type="checkbox"/> |
| | 5087 <input checked="" type="checkbox"/> |

*Base not included. You need to choose a base to complete the installation.

Accessories

| | | | | |
|---|--|--|---|--|
| | | | | |
| Surface Base 15W Ø75x33mm <input type="checkbox"/> 5122 <input checked="" type="checkbox"/> 5123 | Recessed Base 15W Ø90x22mm / Ø80mm <input type="checkbox"/> 5124 <input checked="" type="checkbox"/> 5125 | Wire holder <input type="checkbox"/> 5106 <input checked="" type="checkbox"/> 5107 | Additional wire (1m) <input type="checkbox"/> 5128 <input checked="" type="checkbox"/> 5129 | Side base / Front base Ø25 Side base / Front base Ø28 Side base / Front base Ø33 |

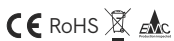

*See pages 276 and 278 for available codes of Side base and Front base.

3 YEARS WARRANTY |
 30.000 HOURS |
 IP 20 |
 100/277 VAC |
 UGR <19 |
 PF >0,9 |
 CRI ≥93 |
 38° |
 50/60 Hz |
 +45°C / -20°C |
 CCT SWITCH |
 1/20





New

Zoe suspension

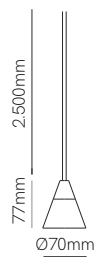

Technical Information

| | |
|-------------------|---------------------------------|
| Version | Zoe suspension |
| Power | 8W |
| Installation | Surface / Recessed |
| Color Temperature | Switch 2.700K / 3.200K / 4.000K |
| Lumens | 570 lm |
| Material | Aluminium |
| Finishes | White / Black |
| Code | 5092 <input type="checkbox"/> |
| | 5093 <input type="checkbox"/> |

*Base not included. You need to choose a base to complete the installation.

Accessories

| | | | | |
|---|--|---|--|--|
| | | | | |
| Surface Base 8W Ø75x33mm <input type="checkbox"/> 5118 <input type="checkbox"/> 5119 | Recessed Base 8W Ø90x22mm / Ø80mm <input type="checkbox"/> 5120 <input type="checkbox"/> 5121 | Wire holder <input type="checkbox"/> 5106 <input type="checkbox"/> 5107 | Additional wire (1m) <input type="checkbox"/> 5128 <input type="checkbox"/> 5129 | Side base / Front base Ø25 Side base / Front base Ø28 Side base / Front base Ø33 |

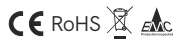

*See pages 276 and 278 for available codes of Side base and Front base.

3 YEARS WARRANTY |
 30.000 HOURS |
 IP 20 |
 100/277 VAC |
 UGR <19 |
 PF >0,9 |
 CRI ≥93 |
 38° |
 50/60 Hz |
 +40°C / -20°C |
 CCT SWITCH |
 1/20

New

Zoe XL suspension

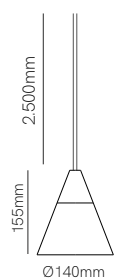

Technical Information

| | |
|-------------------|---------------------------------|
| Version | Zoe XL suspension |
| Power | 15W |
| Installation | Surface / Recessed |
| Color Temperature | Switch 2.700K / 3.200K / 4.000K |
| Lumens | 1.100 lm |
| Material | Aluminium |
| Finishes | White / Black |
| Code | 5094 <input type="checkbox"/> |
| | 5095 <input type="checkbox"/> |

*Base not included. You need to choose a base to complete the installation.

Accessories

| | | | | |
|--|---|---|--|--|
| | | | | |
| Surface Base 15W Ø75x33mm <input type="checkbox"/> 5122 <input type="checkbox"/> 5123 | Recessed Base 15W Ø90x22mm / Ø80mm <input type="checkbox"/> 5124 <input type="checkbox"/> 5125 | Wire holder <input type="checkbox"/> 5106 <input type="checkbox"/> 5107 | Additional wire (1m) <input type="checkbox"/> 5128 <input type="checkbox"/> 5129 | Side base / Front base Ø25 Side base / Front base Ø28 Side base / Front base Ø33 |

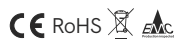

*See pages 276 and 278 for available codes of Side base and Front base.

3 YEARS WARRANTY |
 30.000 HOURS |
 IP 20 |
 100/277 VAC |
 UGR <19 |
 PF >0,9 |
 CRI ≥93 |
 38° |
 50/60 Hz |
 +45°C / -20°C |
 CCT SWITCH |
 1/20







New

Nano alp suspension

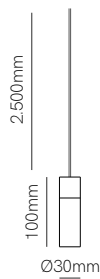

Technical Information

| | |
|-------------------|--|
| Version | Nano alp suspension |
| Power | 5W |
| Installation | Surface / Recessed |
| Color Temperature | Switch 2.700K / 3.200K / 4.000K |
| Lumens | 370 lm |
| Material | Aluminium |
| Finishes | White / Black |
| Code | 5096 <input type="checkbox"/> |
| | 5097 <input checked="" type="checkbox"/> |

*Base not included. You need to choose a base to complete the installation.

Accessories

| | | | | |
|--|---|--|---|--|
|  |  |  |  |  |
| Surface Base 5W Ø75x33mm <input type="checkbox"/> 5114 <input checked="" type="checkbox"/> 5115 | Recessed Base 5W Ø90x22mm / Ø80mm <input type="checkbox"/> 5116 <input checked="" type="checkbox"/> 5117 | Wire holder <input type="checkbox"/> 5106 <input checked="" type="checkbox"/> 5107 | Additional wire (1m) <input type="checkbox"/> 5128 <input checked="" type="checkbox"/> 5129 | Side base / Front base Ø25 Side base / Front base Ø28 Side base / Front base Ø33 |

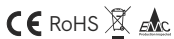

*See pages 276 and 278 for available codes of Side base and Front base.

3 YEARS WARRANTY |
 30.000 HOURS |
 IP 20 |
 100/277 VAC |
 UGR <19 |
 PF >0,9 |
 CRI ≥93 |
 45° |
 50/60 Hz |
 +40°C / -20°C |
 CCT SWITCH |
 1/20

New

Alp suspension

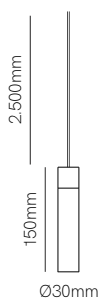

Technical Information

| | |
|-------------------|--|
| Version | Alp suspension |
| Power | 5W |
| Installation | Surface / Recessed |
| Color Temperature | Switch 2.700K / 3.200K / 4.000K |
| Lumens | 370 lm |
| Material | Aluminium |
| Finishes | White / Black |
| Code | 5098 <input type="checkbox"/> |
| | 5099 <input checked="" type="checkbox"/> |

*Base not included. You need to choose a base to complete the installation.

Accessories



Surface Base 5W
Ø75x33mm
 5114
 5115



Recessed Base 5W
Ø90x22mm / Ø80mm
 5116
 5117



Wire holder
 5106
 5107



Additional wire (1m)
 5128
 5129



Side base / Front base Ø25
Side base / Front base Ø28
Side base / Front base Ø33

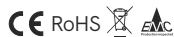

*See pages 276 and 278 for available codes of Side base and Front base.

3 YEARS WARRANTY | 30.000 HOURS | IP 20 | 100/277 VAC | UGR <19 | PF >0,9 | CRI ≥93 | 45° | 50/60 Hz | +40°C / -20°C | CCT SWITCH | 1/20





New

Lievo suspension

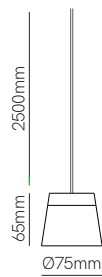

Technical Information

| | |
|-------------------|--|
| Version | Lievo suspension |
| Power | 8W |
| Installation | Surface / Recessed |
| Color Temperature | Switch 2.700K / 3.200K / 4.000K |
| Lumens | 570 lm |
| Material | Aluminium |
| Finishes | White / Black |
| Code | 5088 <input type="checkbox"/> |
| | 5089 <input checked="" type="checkbox"/> |

*Base not included. You need to choose a base to complete the installation.

Accessories



Surface Base 8W
Ø75x33mm
 5118
 5119



Recessed Base 8W
Ø90x22mm / Ø80mm
 5120
 5121



Wire holder
 5106
 5107



Additional wire (1m)
 5128
 5129



Side base / Front base Ø25
Side base / Front base Ø28
Side base / Front base Ø33

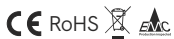

*See pages 276 and 278 for available codes of Side base and Front base.

3 YEARS WARRANTY |
 30.000 HOURS |
 IP 20 |
 100/277 VAC |
 UGR <19 |
 PF >0,9 |
 CRI ≥93 |
 38° |
 50/60 Hz |
 +45°C / -20°C |
 CCT SWITCH |
 1/20

New

Lievo XL suspension

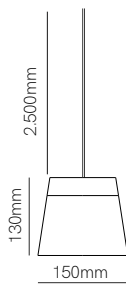

Technical Information

| | |
|-------------------|--|
| Version | Lievo XL suspension |
| Power | 15W |
| Installation | Surface / Recessed |
| Color Temperature | Switch 2.700K / 3.200K / 4.000K |
| Lumens | 1.100 lm |
| Material | Aluminium |
| Finishes | White / Black |
| Code | 5090 <input type="checkbox"/> |
| | 5091 <input checked="" type="checkbox"/> |

*Base not included. You need to choose a base to complete the installation.

Accessories

| | | | | |
|---|---|--|---|--|
| | | | | |
| Surface Base 15W Ø75x33mm <input type="checkbox"/> 5122 <input checked="" type="checkbox"/> 5123 | Recessed Base 15W Ø90x22mm / Ø80mm <input type="checkbox"/> 5124 <input checked="" type="checkbox"/> 5125 | Wire holder <input type="checkbox"/> 5106 <input checked="" type="checkbox"/> 5107 | Additional wire (1m) <input type="checkbox"/> 5128 <input checked="" type="checkbox"/> 5129 | Side base / Front base Ø25 Side base / Front base Ø28 Side base / Front base Ø33 |

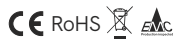

*See pages 276 and 278 for available codes of Side base and Front base.

3 YEARS WARRANTY |
 30.000 HOURS |
 IP 20 |
 100/277 VAC |
 UGR <19 |
 PF >0,9 |
 CRI ≥93 |
 |
 38° |
 |
 50/60 Hz |
 +45°C |
 -20°C |
 |
 CCT SWITCH |
 |
 1/20

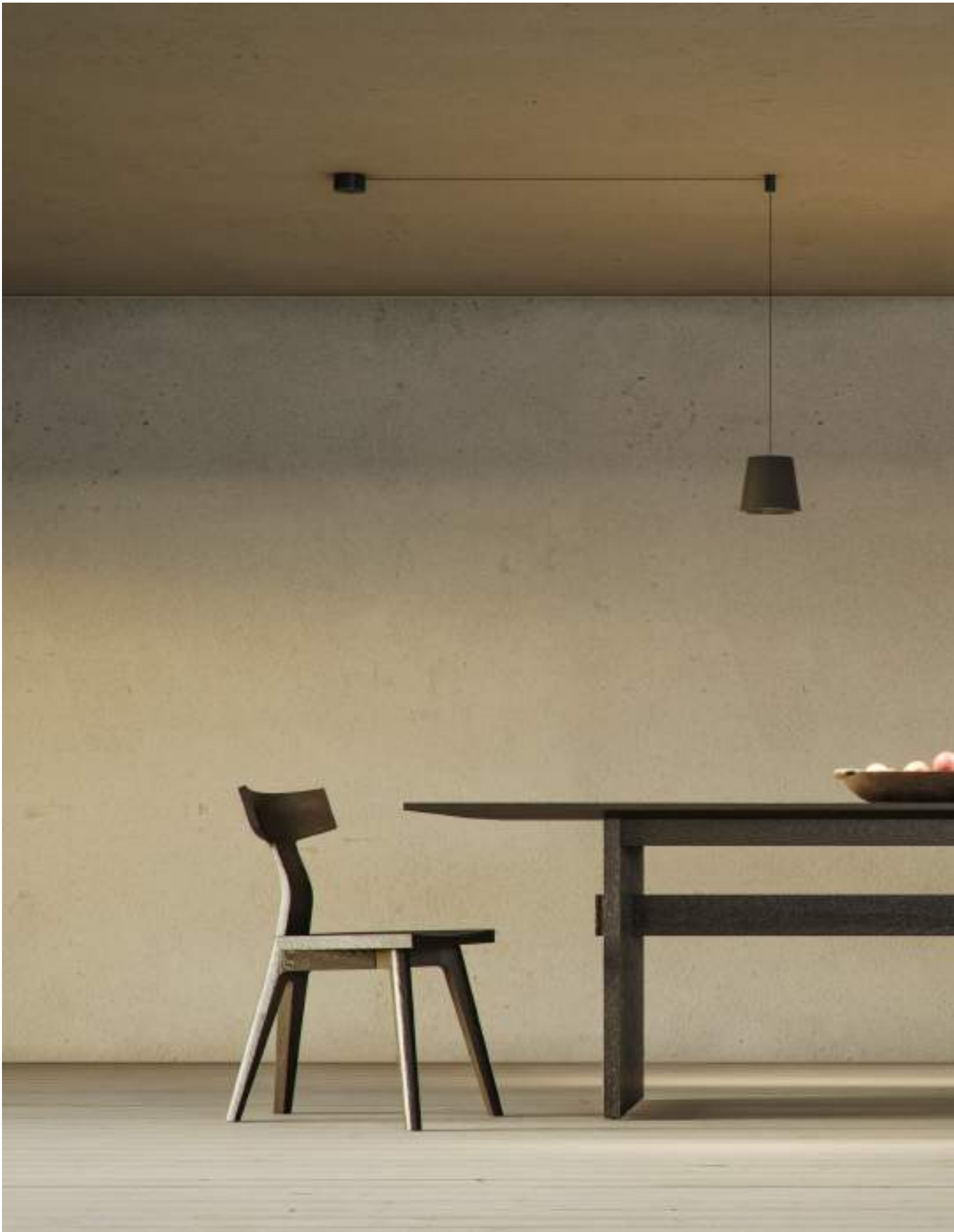

Lievo suspension





Bora suspension surface



Bora suspension recessed

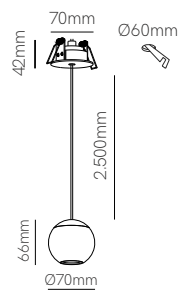

Technical Information

| | |
|-------------------|---------------------------------------|
| Version | Bora suspension surface |
| Power | 8,5W |
| Installation | Surface |
| Color Temperature | 2.700K / 3.000K |
| Lumens | 530 lm / 540 lm |
| Material | Aluminium |
| Finishes | White / Black / Chrome / Rose gold |

| | |
|-------------------|---------------------------------------|
| Version | Bora suspension recessed |
| Power | 8,5W |
| Installation | Recessed |
| Color Temperature | 2.700K / 3.000K |
| Lumens | 530 lm / 540 lm |
| Material | Aluminium |
| Finishes | White / Black / Chrome / Rose gold |

| | | | |
|------|------|-------------------------------------|--------|
| Code | 4605 | <input type="checkbox"/> | 2.700K |
| | 4606 | <input type="checkbox"/> | 3.000K |
| | 4607 | <input checked="" type="checkbox"/> | 2.700K |
| | 4608 | <input checked="" type="checkbox"/> | 3.000K |
| | 4609 | <input type="checkbox"/> | 2.700K |
| | 4610 | <input type="checkbox"/> | 3.000K |
| | 4611 | <input type="checkbox"/> | 2.700K |
| | 4612 | <input type="checkbox"/> | 3.000K |

| | | | |
|------|------|-------------------------------------|--------|
| Code | 4613 | <input type="checkbox"/> | 2.700K |
| | 4614 | <input type="checkbox"/> | 3.000K |
| | 4615 | <input checked="" type="checkbox"/> | 2.700K |
| | 4616 | <input checked="" type="checkbox"/> | 3.000K |
| | 4617 | <input type="checkbox"/> | 2.700K |
| | 4618 | <input type="checkbox"/> | 3.000K |
| | 4619 | <input type="checkbox"/> | 2.700K |
| | 4620 | <input type="checkbox"/> | 3.000K |

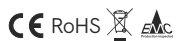

3 YEARS WARRANTY | 26.000 HOURS | IP 20 | 220/240 VAC | UGR <15 | PF >0,6 | CRI >93 | 36° | 50/60 Hz | +40°C / -20°C | 1/18

Bora recessed 4,5W

Bora recessed 8,5W

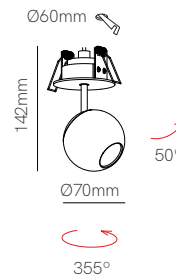
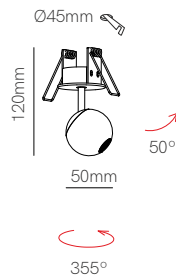

Technical Information

| | | |
|-------------------|------------------------------------|------------------------------------|
| Version | Bora recessed 4,5W | Bora recessed 8,5W |
| Power | 4,5W | 8,5W |
| Installation | Recessed | Recessed |
| Color Temperature | 2.700K / 3.000K | 2.700K / 3.000K |
| Lumens | 290 lm / 300 lm | 530 lm / 540 lm |
| Material | Aluminium | Aluminium |
| Finishes | White / Black / Chrome / Rose gold | White / Black / Chrome / Rose gold |

| | | |
|------|---|---|
| Code | 4589 <input type="checkbox"/> 2.700K | 4597 <input type="checkbox"/> 2.700K |
| | 4590 <input type="checkbox"/> 3.000K | 4598 <input type="checkbox"/> 3.000K |
| | 4591 <input checked="" type="checkbox"/> 2.700K | 4599 <input checked="" type="checkbox"/> 2.700K |
| | 4592 <input checked="" type="checkbox"/> 3.000K | 4600 <input checked="" type="checkbox"/> 3.000K |
| | 4593 <input type="checkbox"/> 2.700K | 4601 <input type="checkbox"/> 2.700K |
| | 4594 <input type="checkbox"/> 3.000K | 4602 <input type="checkbox"/> 3.000K |
| | 4595 <input type="checkbox"/> 2.700K | 4603 <input type="checkbox"/> 2.700K |
| | 4596 <input type="checkbox"/> 3.000K | 4604 <input type="checkbox"/> 3.000K |

UGR <10 | PF >0,5 | 38°

UGR <15 | PF >0,6 | 36°

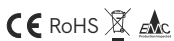

3 YEARS WARRANTY | 26.000 HOURS | IP 20 | 220/240 VAC | CRI ≥93 | | 50/60 Hz | +40°C / -20°C | 1/18



Bora surface 4,5W

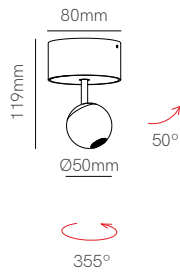

Bora surface 8,5W

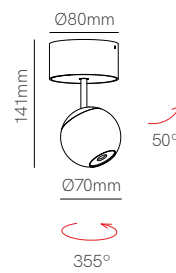

Technical Information

| | | |
|-------------------|------------------------------------|------------------------------------|
| Version | Bora surface 4,5W | Bora surface 8,5W |
| Power | 4,5W | 8,5W |
| Installation | Surface | Surface |
| Color Temperature | 2.700K / 3.000K | 2.700K / 3.000K |
| Lumens | 290 lm / 300 lm | 530 lm / 540 lm |
| Material | Aluminium | Aluminium |
| Finishes | White / Black / Chrome / Rose gold | White / Black / Chrome / Rose gold |

| | | |
|------|---|---|
| Code | 4621 <input type="checkbox"/> 2.700K | 4629 <input type="checkbox"/> 2.700K |
| | 4622 <input type="checkbox"/> 3.000K | 4630 <input type="checkbox"/> 3.000K |
| | 4623 <input checked="" type="checkbox"/> 2.700K | 4631 <input checked="" type="checkbox"/> 2.700K |
| | 4624 <input checked="" type="checkbox"/> 3.000K | 4632 <input checked="" type="checkbox"/> 3.000K |
| | 4625 <input type="checkbox"/> 2.700K | 4633 <input type="checkbox"/> 2.700K |
| | 4626 <input type="checkbox"/> 3.000K | 4634 <input type="checkbox"/> 3.000K |
| | 4627 <input type="checkbox"/> 2.700K | 4635 <input type="checkbox"/> 2.700K |
| | 4628 <input type="checkbox"/> 3.000K | 4636 <input type="checkbox"/> 3.000K |

UGR <10 | PF >0,5 | 38°

UGR <15 | PF >0,6 | 36°

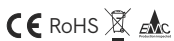

3 YEARS WARRANTY | 26.000 HOURS | IP 20 | 220/240 VAC | CRI ≥93 | | 50/60 Hz | +40°C -20°C | 1/18





Zoe surface



Zoe recessed

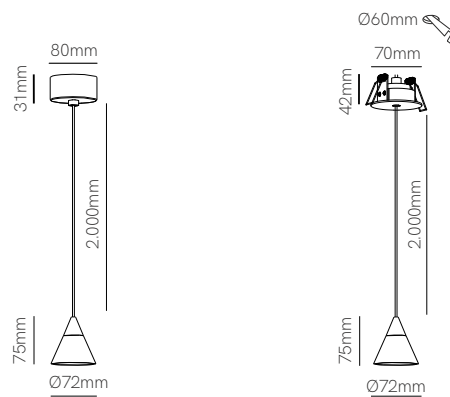

Technical Information

| Version | Zoe surface | Zoe recessed |
|-------------------|-----------------|-----------------|
| Power | 7W | 7W |
| Installation | Surface | Recessed |
| Color Temperature | 2.700K / 3.000K | 2.700K / 3.000K |
| Lumens | 360 lm / 370 lm | 360 lm / 370 lm |
| Material | Aluminium | Aluminium |
| Finishes | White / Black | White / Black |

| Code | Zoe surface | Zoe recessed |
|------|---|---|
| | 4803 <input type="checkbox"/> 2.700K | 4799 <input type="checkbox"/> 2.700K |
| | 4804 <input type="checkbox"/> 3.000K | 4800 <input type="checkbox"/> 3.000K |
| | 4805 <input checked="" type="checkbox"/> 2.700K | 4801 <input checked="" type="checkbox"/> 2.700K |
| | 4806 <input checked="" type="checkbox"/> 3.000K | 4802 <input checked="" type="checkbox"/> 3.000K |

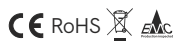

3 YEARS WARRANTY | 26.000 HOURS | IP 20 | 220/240 VAC | UGR <19 | PF >0,5 | CRI ≥90 | 38° | 50/60 Hz | +40°C / -20°C | | 1/36



New

Atmos slim 25

Atmos slim 45

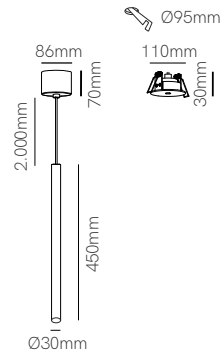
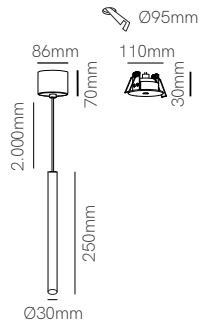

*Need Tuya Smart App to work.

Technical Information

| | | |
|-------------------|---|---|
| Version | Atmos Slim 25 | Atmos Slim 45 |
| Power | 6W | 6W |
| Installation | Surface / Recessed | Surface / Recessed |
| Color Temperature | Tuya 2.700K - 4.000K | Tuya 2.700K - 4.000K |
| Lumens | 460 lm | 460 lm |
| Material | Aluminium | Aluminium |
| Finishes | White / Black / Chrome / Wood | White / Black / Chrome / Wood |
| Code | 4930 <input type="checkbox"/> 4931 <input checked="" type="checkbox"/> 4932 <input type="checkbox"/> ① 5130 <input checked="" type="checkbox"/> Wood | 4750 <input type="checkbox"/> 4751 <input checked="" type="checkbox"/> 4752 <input type="checkbox"/> ① 5131 <input checked="" type="checkbox"/> Wood New |

Accessories



① On demand. *See page 8 for Gateway additional info.

*All versions included surface base (mounted) and recessed base (not mounted).

3 YEARS WARRANTY | 30.000 HOURS | IP 20 | 220/240 VAC | UGR <19 | PF >0,9 | CRI ≥90 | | 45° | 50/60 Hz | +50°C / -10°C | IK03 | |

Atmos 25

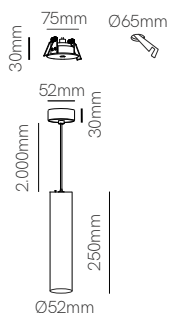

Atmos 45

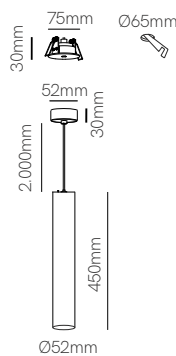

Technical Information

| | | |
|-------------------|---------------------------------|---------------------------------|
| Version | Atmos 25 | Atmos 45 |
| Power | 7W | 10W |
| Installation | Surface / Recessed | Surface / Recessed |
| Color Temperature | Switch 2.700K / 3.200K / 4.000K | Switch 2.700K / 3.200K / 4.000K |
| Lumens | 770 lm | 1.100 lm |
| Material | Aluminium | Aluminium |
| Finishes | White / Black / Chrome / Wood | White / Black / Chrome / Wood |

| | | |
|------|---|---|
| Code | 4461 <input type="checkbox"/> | 4463 <input type="checkbox"/> |
| | 4462 <input checked="" type="checkbox"/> | 4464 <input checked="" type="checkbox"/> |
| | 4952 <input type="checkbox"/> | 4953 <input type="checkbox"/> |
| | Ⓢ 5132 <input checked="" type="checkbox"/> Wood New | Ⓢ 5134 <input checked="" type="checkbox"/> Wood New |



Accessories



Included with:
4461 / 4463



Included with:
4461 / 4462 / 4463 / 4464

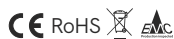

Ⓢ On demand.

*All versions included surface base (mounted) and recessed base (not mounted).

3 YEARS WARRANTY | 30.000 HOURS | IP 20 | 220/240 VAC | UGR <19 | PF >0,9 | CRI ≥80 | 15° / 38° / 60° | 50/60 Hz | +50°C / -20°C | CCT SWITCH |



Atmos 25 GU10



Atmos 45 GU10

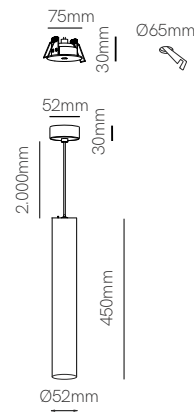
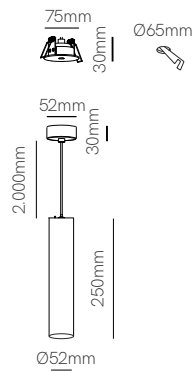

Technical Information

| | | |
|--------------|--|--|
| Version | Atmos 25 GU10 | Atmos 45 GU10 |
| Installation | Surface / Recessed | Surface / Recessed |
| Material | Aluminium | Aluminium |
| Finishes | White / Black / Chrome / Wood | White / Black / Chrome / Wood |
| Code | 4465 <input type="checkbox"/> 4466 <input checked="" type="checkbox"/> 4954 <input type="checkbox"/> | 4467 <input type="checkbox"/> 4468 <input checked="" type="checkbox"/> 4955 <input type="checkbox"/> |

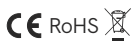

*All versions included surface base (mounted) and recessed base (not mounted).

3 YEARS WARRANTY | IP 20 | 220/240 VAC |





Ark surface

Ark recessed

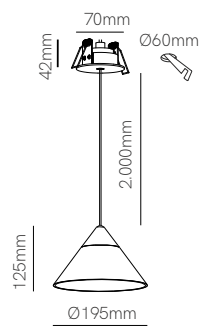
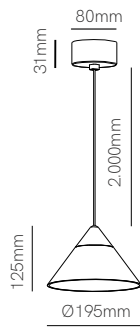

Technical Information

| Version | Ark surface | Ark recessed |
|-------------------|--|--|
| Power | 6W | 6W |
| Installation | Surface | Recessed |
| Color Temperature | 2.700K / 3.000K | 2.700K / 3.000K |
| Lumens | 350 lm / 360 lm | 350 lm / 360 lm |
| Material | Aluminium and acrylic | Aluminium and acrylic |
| Finishes | White-transparent / Black-transparent / Black-gray | White-transparent / Black-transparent / Black-gray |
| Code | 4814 White-transp. 2.700K 4815 White-transp. 3.000K 4816 Black-transp. 2.700K 4817 Black-transp. 3.000K 4818 Black-gray 2.700K 4819 Black-gray 3.000K | 4808 White-transp. 2.700K 4809 White-transp. 3.000K 4810 Black-transp. 2.700K 4811 Black-transp. 3.000K 4812 Black-gray 2.700K 4813 Black-gray 3.000K |



3 YEARS WARRANTY | 26.000 HOURS | IP 20 | 220/240 VAC | UGR <19 | PF >0,5 | CRI ≥90 | | 90° | 50/60 Hz | +40°C / -20°C | 1/12



New

Volt round 1

Volt square 1

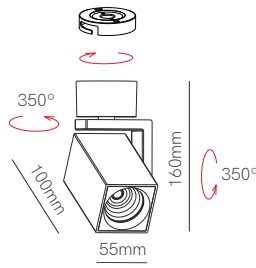
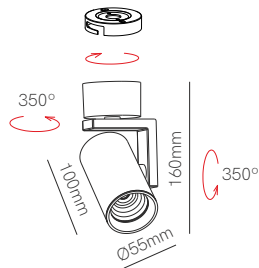

Technical Information

| Version | Volt round 1 | Volt square 1 |
|-------------------|---|---|
| Power | 8W | 8W |
| Installation | Surface / Recessed | Surface / Recessed |
| Color Temperature | Switch 2.700K / 3.200K / 4.000K | Switch 2.700K / 3.200K / 4.000K |
| Lumens | 570 lm | 570 lm |
| Material | Aluminium | Aluminium |
| Finishes | White / Black | White / Black |
| Code | 5041 <input type="checkbox"/> 5042 <input checked="" type="checkbox"/> | 5043 <input type="checkbox"/> 5044 <input checked="" type="checkbox"/> |

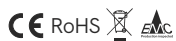

*Included surface base (mounted) and recessed base (not mounted).

3 YEARS WARRANTY | 30.000 HOURS | IP 20 | 100/277 VAC | PF >0,9 | CRI ≥90 | 38° | IK06 | 50/60 Hz | +45°C / -20°C | CCT SWITCH | 1/20

New

Volt round 3

Volt square 3

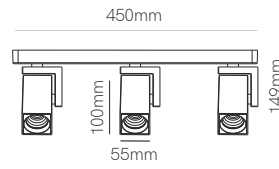
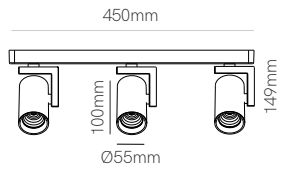

Technical Information

| Version | Volt round 3 | Volt square 3 |
|-------------------|---|---|
| Power | 24W | 24W |
| Installation | Surface | Surface |
| Color Temperature | Switch 2.700K / 3.200K / 4.000K | Switch 2.700K / 3.200K / 4.000K |
| Lumens | 1.700 lm | 1.700 lm |
| Material | Aluminium | Aluminium |
| Finishes | White / Black | White / Black |
| Code | 5045 <input type="checkbox"/> 5046 <input checked="" type="checkbox"/> | 5047 <input type="checkbox"/> 5048 <input checked="" type="checkbox"/> |

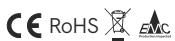

3 YEARS WARRANTY | 30.000 HOURS | IP 20 | 100/277 VAC | PF >0,9 | CRI ≥90 | 38° | IK06 | 50/60 Hz | +45°C / -20°C | CCT SWITCH | 1/10



New

Volt round 1 GU10

Volt square 1 GU10

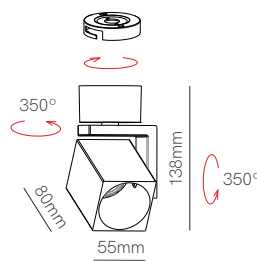
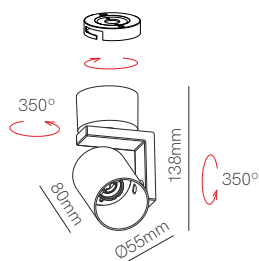

Technical Information

| | | |
|--------------|--|--|
| Version | Volt round 1 GU10 | Volt square 1 GU10 |
| Installation | Surface / Recessed | Surface / Recessed |
| Material | Aluminium | Aluminium |
| Finishes | White / Black | White / Black |
| Code | 5049 <input type="checkbox"/> | 5051 <input type="checkbox"/> |
| | 5050 <input checked="" type="checkbox"/> | 5052 <input checked="" type="checkbox"/> |



*Included surface base (mounted) and recessed base (not mounted).



New

Volt round 3 GU10

Volt square 3 GU10

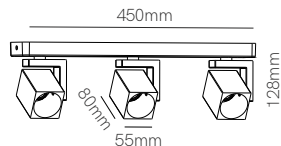
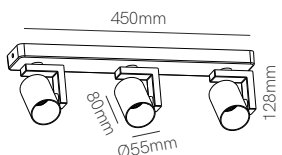

Technical Information

| | | |
|--------------|--|--|
| Version | Volt round 3 GU10 | Volt square 3 GU10 |
| Installation | Surface | Surface |
| Material | Aluminium | Aluminium |
| Finishes | White / Black | White / Black |
| Code | 5053 <input type="checkbox"/> | 5055 <input type="checkbox"/> |
| | 5054 <input checked="" type="checkbox"/> | 5056 <input checked="" type="checkbox"/> |

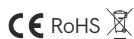



Tot 40W



Tot 60W

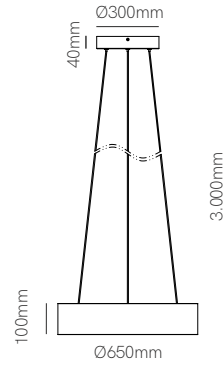
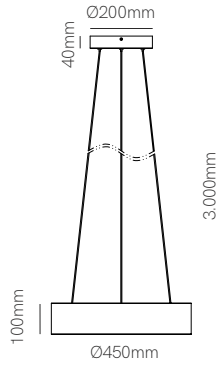

*Need Tuya Smart App to work.

Technical Information

| | | |
|-------------------|--|--|
| Version | Tot 40W | Tot 60W |
| Power | 40W | 60W |
| Installation | Surface / Recessed / Pendant | Surface / Recessed / Pendant |
| Color Temperature | Tuya 2.600K - 4.000K | Tuya 2.600K - 4.000K |
| Lumens | 3.400 lm | 5.900 lm |
| Material | Aluminium and polycarbonate | Aluminium and polycarbonate |
| Finishes | White / Black / Wood | White / Black / Wood |
| Code | 4902 <input type="checkbox"/> 4903 <input type="checkbox"/> 5137 <input type="checkbox"/> Wood New | 4904 <input type="checkbox"/> 4905 <input type="checkbox"/> 5138 <input type="checkbox"/> Wood New |

Accessories



ⓘ On demand. *See page 8 for Gateway additional info.
*Included recessed base (not mounted) and surface base (mounted).

3 YEARS WARRANTY | 30.000 HOURS | IP 20 | 220/240 VAC | PF >0,9 | CRI ≥80 | 115° | 50/60 Hz | +50°C / -20°C | |



New

Rubyc dimmable

Rubyc

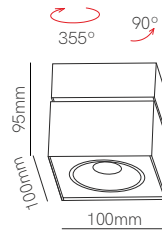
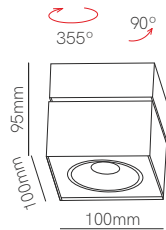

Technical Information

| | | |
|-------------------|--|--|
| Version | Rubyc dimmable | Rubyc |
| Power | 14W | 14W |
| Installation | Surface | Surface |
| Color Temperature | Switch 2.700K / 3.200K / 4.000K | Switch 2.700K / 3.200K / 4.000K |
| Lumens | 1.205 lm | 1.205 lm |
| Material | Aluminium | Aluminium |
| Finishes | White / Black | White / Black |
| Code | 5069 <input type="checkbox"/> | 4230-N <input type="checkbox"/> |
| | 5070 <input checked="" type="checkbox"/> | 4231-N <input checked="" type="checkbox"/> |



3 YEARS WARRANTY | 30.000 HOURS | IP 20 | 220/240 VAC | PF >0,9 | CRI ≥97 | 40° | 50/60 Hz | +40°C / -10°C | CCT SWITCH | AKZO NOBEL | 1/4/12

New

Mini rubyc dimmable

Mini rubyc

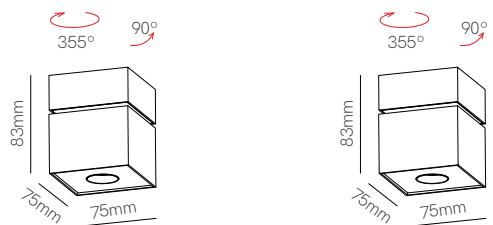

Technical Information

| | | |
|-------------------|---|---|
| Version | Mini rubyc dimmable | Mini rubyc |
| Power | 7W | 7W |
| Installation | Surface | Surface |
| Color Temperature | Switch 2.700K / 3.200K / 4.000K | Switch 2.700K / 3.200K / 4.000K |
| Lumens | 850 lm | 850 lm |
| Material | Aluminium | Aluminium |
| Finishes | White / Black | White / Black |
| Code | 4332-N <input type="checkbox"/> 4333-N <input checked="" type="checkbox"/> | 4332 <input type="checkbox"/> 4333 <input checked="" type="checkbox"/> |

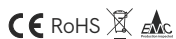

3 YEARS WARRANTY | 30.000 HOURS | IP 20 | 220/240 VAC | PF >0,9 | CRI ≥80 | 40° | 50/60 Hz | +40°C / -20°C | CCT SWITCH | AKZO NOBEL | 1/30





New

Concord dimmable

Concord

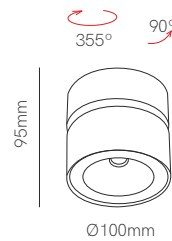
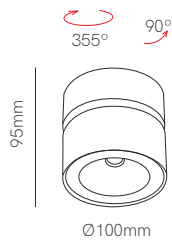

Technical Information

| | | |
|-------------------|---|---|
| Version | Concord dimmable | Concord |
| Power | 14W | 14W |
| Installation | Surface | Surface |
| Color Temperature | Switch 2.700K / 3.200K / 4.000K | Switch 2.700K / 3.200K / 4.000K |
| Lumens | 1.205 lm | 1.205 lm |
| Material | Aluminium | Aluminium |
| Finishes | White / Black | White / Black |
| Code | 5071 <input type="checkbox"/> 5072 <input checked="" type="checkbox"/> | 4232-N <input type="checkbox"/> 4233-N <input checked="" type="checkbox"/> |



3 YEARS WARRANTY | 30.000 HOURS | IP 20 | 220/240 VAC | PF >0,9 | CRI ≥97 | 40° | 50/60 Hz | +40°C / -10°C | CCT SWITCH | AKZO NOBEL | 1/4/12

New

Mini concord dimmable

Mini concord

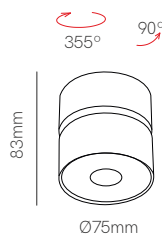
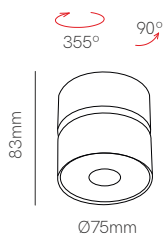

Technical Information

| | | |
|-------------------|---|---|
| Version | Mini concord dimmable | Mini concord |
| Power | 7W | 7W |
| Installation | Surface | Surface |
| Color Temperature | Switch 2.700K / 3.000K / 4.000K | Switch 2.700K / 3.000K / 4.000K |
| Lumens | 850 lm | 850 lm |
| Material | Aluminium | Aluminium |
| Finishes | White / Black | White / Black |
| Code | 4334-N <input type="checkbox"/> 4335-N <input checked="" type="checkbox"/> | 4334 <input type="checkbox"/> 4335 <input checked="" type="checkbox"/> |

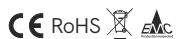

3 YEARS WARRANTY | 30.000 HOURS | IP 20 | 220/240 VAC | PF >0,9 | CRI ≥80 | 40° | 50/60 Hz | +40°C / -20°C | CCT SWITCH | AKZO NOBEL | 1/30





Plus

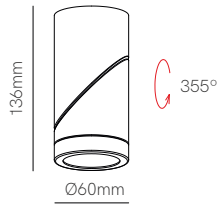

Technical Information

| | |
|-------------------|--|
| Version | Plus |
| Power | 8W |
| Installation | Surface |
| Color Temperature | Switch 2.700K / 3.200K / 4.000K |
| Lumens | 1.040 lm |
| Material | Aluminium |
| Finishes | White / Black |
| Code | 4522 <input type="checkbox"/> |
| | 4523 <input checked="" type="checkbox"/> |



3 YEARS WARRANTY | 30.000 HOURS | IP 20 | 220/240 VAC | PF >0,9 | CRI ≥80 |
 15° | 35° | 60° |
 50/60 Hz | +45°C | -20°C |
 CCT SWITCH |
 1/20







New

Mac wall 120mm

Mac wall 180mm

Mac wall 250mm

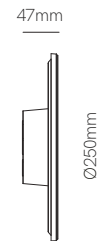
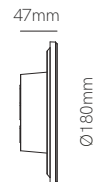
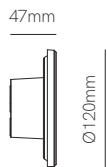

Technical Information

| Version | Mac wall 120mm | Mac wall 180mm | Mac wall 250mm |
|-------------------|--|--|--|
| Power | 6W | 15W | 20W |
| Installation | Surface | Surface | Surface |
| Color Temperature | Switch 2.700K / 3.200K / 4.000K | Switch 2.700K / 3.200K / 4.000K | Switch 2.700K / 3.200K / 4.000K |
| Lumens | 600 lm | 1.500 lm | 2.000 lm |
| Material | Aluminium + pc / Pc (wood) | Aluminium + pc / Pc (wood) | Aluminium + pc / Pc (wood) |
| Finishes | White / Black / Wood | White / Black / Wood | White / Black / Wood |
| Code | 4995 <input type="checkbox"/> 4996 <input checked="" type="checkbox"/> 4997 <input checked="" type="checkbox"/> Wood | 4998 <input type="checkbox"/> 4999 <input checked="" type="checkbox"/> 5000 <input checked="" type="checkbox"/> Wood | 5001 <input type="checkbox"/> 5002 <input checked="" type="checkbox"/> 5003 <input checked="" type="checkbox"/> Wood |



3 YEARS WARRANTY | 25.000 HOURS | IP 65 | 220/240 VAC | PF >0,9 | CRI ≥80 | 360° | 50/60 Hz | IK06 | TRIAC DIMM | +40°C / -20°C | CCT SWITCH | 1/10



Mac wall





New

One wall



One wall dual

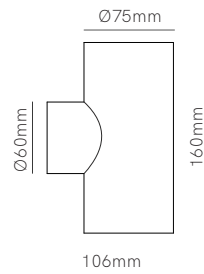
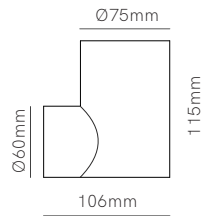

Technical Information

| | | |
|--------------|--|--|
| Version | One wall | One wall dual |
| Installation | Surface | Surface |
| Material | Aluminium | Aluminium |
| Finishes | White / Black / Corten | White / Black / Corten |
| Bulbholder | 50mm GU10 | 50mm GU10 |
| Code | 5006 <input type="checkbox"/> | 5009 <input type="checkbox"/> |
| | 5007 <input checked="" type="checkbox"/> | 5010 <input checked="" type="checkbox"/> |
| | 5008 <input checked="" type="checkbox"/> | 5011 <input checked="" type="checkbox"/> |



*GU10 Bulbholder included.





New

Zio wall

Zio wall dual

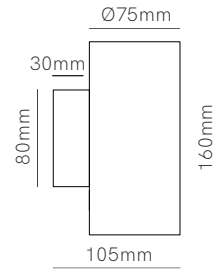
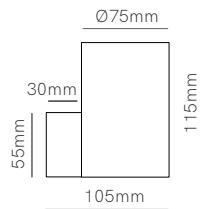

Technical Information

| | | |
|--------------|--|--|
| Version | Zio wall | Zio wall dual |
| Installation | Surface | Surface |
| Material | Aluminium | Aluminium |
| Finishes | White / Black / Corten | White / Black / Corten |
| Bulbholder | 50mm GU10 | 50mm GU10 |
| Code | 5012 <input type="checkbox"/> | 5015 <input type="checkbox"/> |
| | 5013 <input checked="" type="checkbox"/> | 5016 <input checked="" type="checkbox"/> |
| | 5014 <input checked="" type="checkbox"/> | 5017 <input checked="" type="checkbox"/> |



*GU10 Bulbholder included.





One wall, Zio wall





Icon 7W



Icon 12W

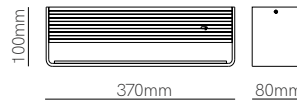
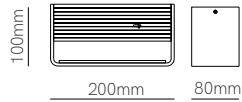

Technical Information

| | | |
|-------------------|--|--|
| Version | Icon 7W | Icon 12W |
| Power | 7W | 12W |
| Installation | Surface | Surface |
| Color Temperature | Switch 2.700K / 3.200K / 4.000K | Switch 2.700K / 3.200K / 4.000K |
| Lumens | 770 lm | 1.320 lm |
| Material | Aluminium | Aluminium |
| Finishes | White / Black / Corten | White / Black / Corten |
| Code | 4383 <input type="checkbox"/> | 4386 <input type="checkbox"/> |
| | 4384 <input checked="" type="checkbox"/> | 4387 <input checked="" type="checkbox"/> |
| | 4385 <input checked="" type="checkbox"/> | 4388 <input checked="" type="checkbox"/> |

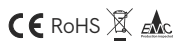

3 YEARS WARRANTY | 30.000 HOURS | IP 20 | 220/240 VAC | UGR <14 | PF >0,5 | CRI >90 | 120° | 50/60 Hz | +50°C / -20°C | CCT SWITCH | 1/12



Sweet

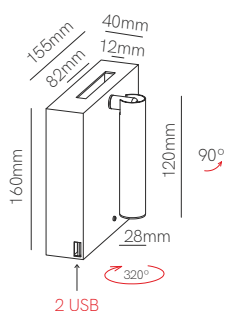

Technical Information

| | |
|-------------------|--|
| Version | Sweet |
| Power | 4W |
| Installation | Surface |
| Color Temperature | 2.700K |
| Lumens | 150 lm / 90 lm / 40 lm |
| Material | Aluminium |
| Finishes | White / Black |
| Code | 4174 <input type="checkbox"/> |
| | 4175 <input checked="" type="checkbox"/> |

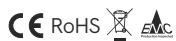

*Charger by induction and USB.

3 YEARS WARRANTY | 30.000 HOURS | IP 20 | 220/240 VAC | PF >0,4 | CRI ≥80 | | 20° | 5W | 50/60 Hz | 3 INTENSITIES | +40°C / -20°C | 1/10







Beam

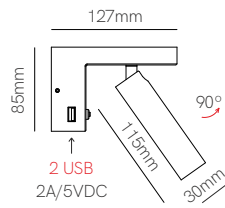
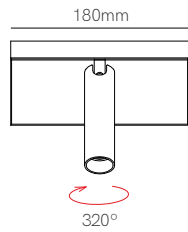

Technical Information

| | |
|-------------------|--|
| Version | Beam |
| Power | 5W |
| Installation | Surface |
| Color Temperature | 2.700K |
| Lumens | 380 lm / 190 lm / 95 lm |
| Material | Aluminium |
| Finishes | White / Black |
| Code | 3958 <input type="checkbox"/> |
| | 3959 <input checked="" type="checkbox"/> |



*Charger by USB.

5 YEARS WARRANTY | 30.000 HOURS | IP 20 | 220/240 VAC | PF >0,9 | CRI ≥90 | 40° | 50/60 Hz | 3 INTENSITIES | +40°C / -20°C | 1/12



Pure

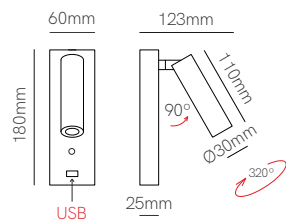

Technical Information

| | |
|-------------------|---|
| Version | Pure |
| Power | 4W |
| Installation | Surface |
| Color Temperature | 2.700K |
| Lumens | 200 lm / 100 lm / 50 lm |
| Material | Aluminium |
| Finishes | White / Black |
| Code | 4142-V2 <input type="checkbox"/> |
| | 4143-V2 <input checked="" type="checkbox"/> |



*Charger by USB.

3 YEARS WARRANTY | 30.000 HOURS | IP 20 | 220/240 VAC | PF >0,5 | CRI ≥80 | 30° | 50/60 Hz | 3 INTENSITIES | +40°C / -20°C | 1/20



New

Lao

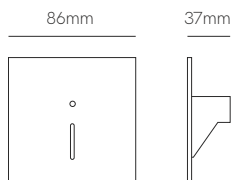

Ø73mm 



Recessed box included
66mm x Ø73mm



White and black cover included



Technical Information

| | |
|-------------------|---|
| Version | Lao |
| Power | 1,5W |
| Installation | Recessed |
| Color Temperature | Switch 2.700K / 3.200K / 4.000K |
| Lumens | 20 lm |
| Material | Aluminium |
| Finishes | White / Black |
| Code | 5027 <input type="checkbox"/> <input checked="" type="checkbox"/> |

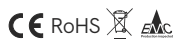

*Recessed box, white and black cover included.

3 YEARS WARRANTY | 25.000 HOURS | IP 20 | 175/265 VAC | PF >0,4 | CRI ≥80 |  | 38°  | 50/60 Hz |  +45°C / -20°C |  6-8m |  ON  OFF |  OFF 30 sec |  CCT SWITCH |  |  1/50



New

Pun

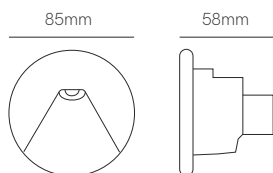

Ø73mm 



Recessed box included
66mm x Ø73mm



White and black cover included



Technical Information

| | |
|-------------------|---|
| Version | Pun |
| Power | 3W |
| Installation | Recessed |
| Color Temperature | Switch 2.700K / 3.200K / 4.000K |
| Lumens | 65 lm |
| Material | Aluminium |
| Finishes | White / Black |
| Code | 5029 <input type="checkbox"/> <input checked="" type="checkbox"/> |

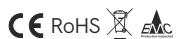

*Recessed box, white and black cover included.

3 YEARS WARRANTY |
 25.000 HOURS |
 IP 20 |
 175/265 VAC |
 PF >0,4 |
 CRI ≥80 |
  |
 38°  |
 50/60 Hz |
  IK07 |
  +45°C / -20°C |
  CCT SWITCH |
  |
  1/50



Ilo

Skin

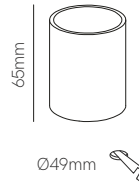
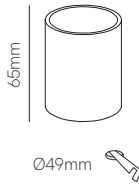
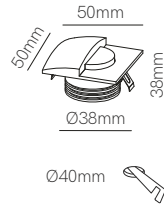
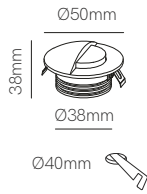

Technical Information

| Version | Ilo | Skin |
|-------------------|---|---|
| Power | 2W | 2W |
| Installation | Recessed | Recessed |
| Color Temperature | 3.000K | 3.000K |
| Lumens | 60 lm | 60 lm |
| Material | Aluminium | Aluminium |
| Finishes | White / Black | White / Black |
| Code | 4126 <input type="checkbox"/> 4127 <input checked="" type="checkbox"/> | 4108 <input type="checkbox"/> 4109 <input checked="" type="checkbox"/> |



*Recessed box included.



Port

Grow

Steps

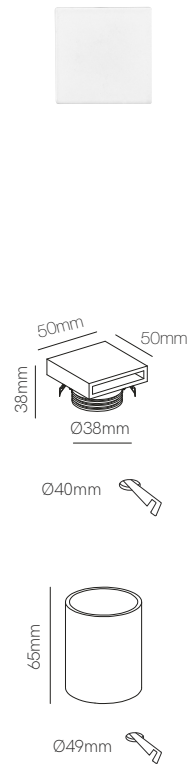
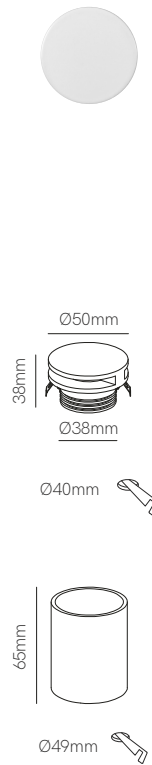
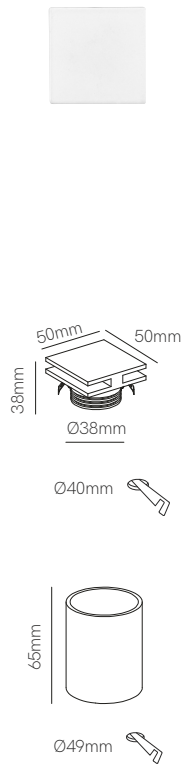

Technical Information

| Version | Port | Grow | Steps |
|-------------------|---|---|---|
| Power | 4W | 4W | 4W |
| Installation | Recessed | Recessed | Recessed |
| Color Temperature | 3.000K | 3.000K | 3.000K |
| Lumens | 60 lm | 60 lm | 60 lm |
| Material | Aluminium | Aluminium | Aluminium |
| Finishes | White / Black | White / Black | White / Black |
| Code | 4112 <input type="checkbox"/> 4113 <input checked="" type="checkbox"/> | 4106 <input type="checkbox"/> 4107 <input checked="" type="checkbox"/> | 4110 <input type="checkbox"/> 4111 <input checked="" type="checkbox"/> |
| | 120° | 120° | 120° |



*Recessed box included.

3 YEARS WARRANTY | 25.000 HOURS | IP 20 | 220/240 VAC | PF >0,5 | CRI ≥80 | | 50/60 Hz | | +50°C / -20°C | |

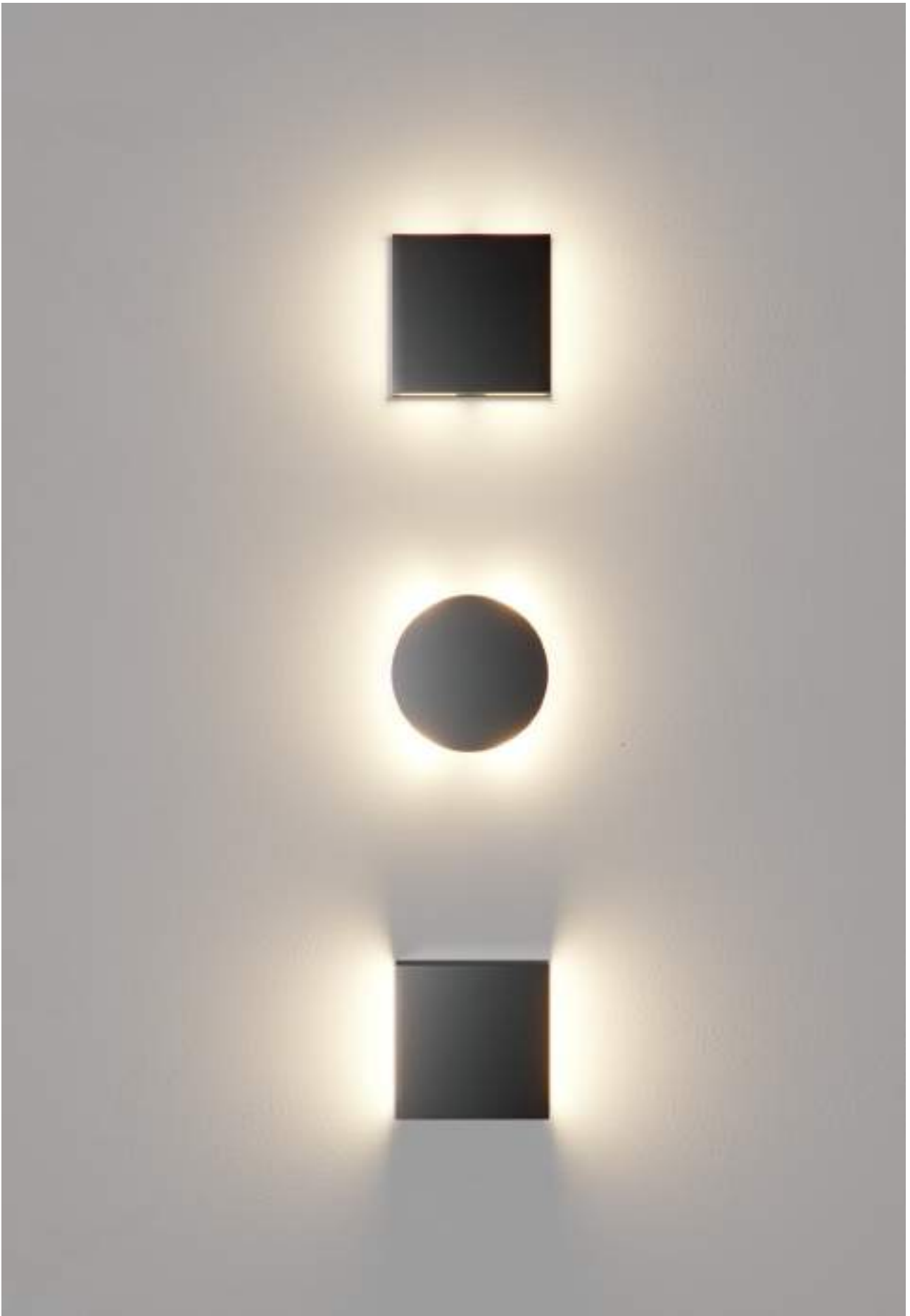



New

Stem

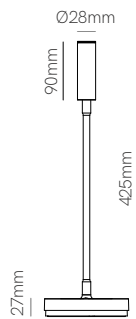

Technical Information

| | |
|-------------------|--|
| Version | Stem |
| Power | 5W |
| Installation | Desktop |
| Color Temperature | 2.700K |
| Lumens | 175 lm |
| Material | Aluminium and polycarbonate |
| Finishes | White / Black |
| Code | 4979 <input type="checkbox"/> |
| | 4981 <input checked="" type="checkbox"/> |



3 YEARS WARRANTY | 30.000 HOURS | IP 20 | 220/240 VAC | PF >0,45 | CRI ≥90 | 30° | 5W (⚡) | 50/60 Hz | IK06 | +50°C / -20°C | 1/20



New

Lievo switch

Lievo

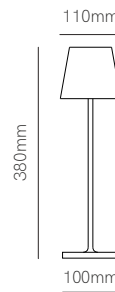
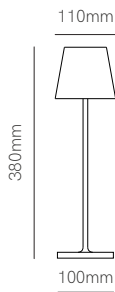

Technical Information

| | | |
|-------------------|---------------------------------|------------------------|
| Version | Lievo switch | Lievo |
| Power | 3,5W | 3,5W |
| Installation | Portable | Portable |
| Color Temperature | Switch 2.700K / 3.200K / 4.000K | 3.000K |
| Lumens | 270 lm | 156 lm |
| Material | Aluminium | Aluminium |
| Finishes | White / Black / Corten | White / Black / Corten |

| | | |
|------|---------------------------------|-------------------------------|
| Code | 4739-N <input type="checkbox"/> | 4739 <input type="checkbox"/> |
| | 4740-N <input type="checkbox"/> | 4740 <input type="checkbox"/> |
| | 4925-N <input type="checkbox"/> | 4925 <input type="checkbox"/> |

5,200 mAh |
 USB-C 5V |
 CCT SWITCH
 CRI >90 |
 120° |
 4-6 HOURS

5-8 HOURS |
 5,200 mAh |
 MICRO USB 5V
 CRI >85 |
 90°



3 YEARS WARRANTY BATTERY 2 YEARS |
 30.000 HOURS |
 10-15 HOURS |
 IP 54 |
 DIMMABLE |
 IK08 |
 +40°C |
 -25°C |
 |
 1/6



Converse lighting

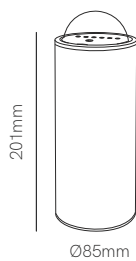

Technical Information

| | |
|-------------------|---------------------------------|
| Version | Converse lighting |
| Power | 2,5W |
| Installation | Portable |
| Color Temperature | 2.700K / 5.000K |
| Lumens | 225 lm |
| Finishes | White |
| Code | 3916-N <input type="checkbox"/> |



3 YEARS WARRANTY BATTERY 2 YEARS | 50.000 HOURS | 5-6 HOURS | 4-150 HOURS | MICRO USB 5V | 2.200 mAh | IP 20 | CRI ≥82 | 360° | DIMMABLE | +40°C -20°C | 1/15

Downlights

371. Kora
375. Thessis
379. Air
381. Noi
383. Compac



Kora round 20W

Kora round 25W

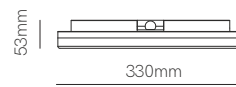
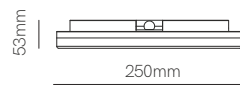

Technical Information

| | | |
|-------------------|---------------------------------|----------------------------------|
| Version | Kora round 20W | Kora round 25W |
| Power | 20W | 25W |
| Installation | Surface | Surface |
| Color Temperature | Switch 2.700K / 3.200K / 4.000K | Switch 2.700K / 3.200K / 4.000K |
| Lumens | 2.400 lm | 3.000 lm |
| Material | Polybutylene and Polycarbonate | Polybutylene and Polycarbonate |
| Finishes | White | White |
| Code | 4832 <input type="checkbox"/> | 4500-V2 <input type="checkbox"/> |



3 YEARS WARRANTY | 25.000 HOURS | IP 40 | 220/240 VAC | PF >0,9 | CRI ≥80 | 120° | 50/60 Hz | IK08 | +45°C / -25°C | CCT SWITCH | 1/5

Kora square 20W

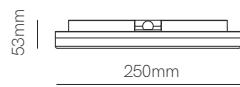

Kora square 25W

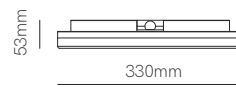

Technical Information

| Version | Kora square 20W | Kora square 25W |
|-------------------|---------------------------------|----------------------------------|
| Power | 20W | 25W |
| Installation | Surface | Surface |
| Color Temperature | Switch 2.700K / 3.200K / 4.000K | Switch 2.700K / 3.200K / 4.000K |
| Lumens | 2.400 lm | 3.000 lm |
| Material | Polybutylene and Polycarbonate | Polybutylene and Polycarbonate |
| Finishes | White | White |
| Code | 4831 <input type="checkbox"/> | 4499-V2 <input type="checkbox"/> |

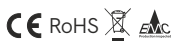

3 YEARS WARRANTY | 25.000 HOURS | IP 40 | 220/240 VAC | PF >0,9 | CRI ≥80 | 120° | 50/60 Hz | IK08 | +45°C / -25°C | CCT SWITCH | 1/5





New

Thessis 15W

Thessis 25W

Thessis 35W

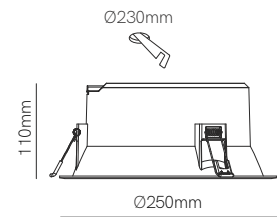
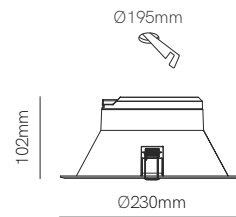
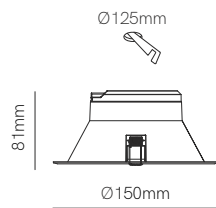

Technical Information

| | | | |
|-------------------|--|--|---------------------------------|
| Version | Thessis 15W | Thessis 25W | Thessis 35W |
| Power | 15W | 25W | 35W |
| Installation | Recessed | Recessed | Recessed |
| Color Temperature | Switch 3.000K / 4.000K / 5.000K | Switch 3.000K / 4.000K / 5.000K | Switch 3.000K / 4.000K / 5.000K |
| Lumens | 1.300 lm | 2.625 lm | 3.100 lm |
| Material | Polybutylene and Polycarbonate | Polybutylene and Polycarbonate | Polybutylene and Polycarbonate |
| Finishes | White / Black | White / Black | White |
| Code | 4766 <input type="checkbox"/> 4987 <input checked="" type="checkbox"/> New | 4236 <input type="checkbox"/> 4988 <input checked="" type="checkbox"/> New | 5030 <input type="checkbox"/> |
| | UGR <19 | UGR <19 | |



3 YEARS WARRANTY | 25.000 HOURS | IP 40 | 220/240 VAC | PF >0,9 | CRI ≥85 | 90° | 50/60 Hz | IK06 | +40°C / -20°C | CCT SWITCH | 1/6

Thesis 15W dimmable

Thesis 25W dimmable

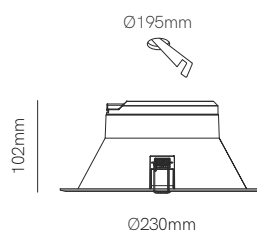
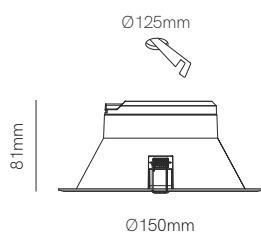

Technical Information

| | | |
|-------------------|---------------------------------|---------------------------------|
| Version | Thesis 15W dimmable | Thesis 25W dimmable |
| Power | 15W | 25W |
| Installation | Recessed | Recessed |
| Color Temperature | Switch 3.000K / 4.000K / 5.000K | Switch 3.000K / 4.000K / 5.000K |
| Lumens | 1.300 lm | 2.625 lm |
| Material | Polybutylene and Polycarbonate | Polybutylene and Polycarbonate |
| Finishes | White / Black | White / Black |
| Code | 4767 <input type="checkbox"/> | 4691 <input type="checkbox"/> |

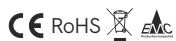

3 YEARS WARRANTY | 25.000 HOURS | IP 40 | 220/240 VAC | UGR <19 | PF >0,9 | CRI ≥85 | 90° | 50/60 Hz | IK06 | TRIAC DIMM | +40°C / -20°C | CCT SWITCH | 1/6





New

Air switch

Air

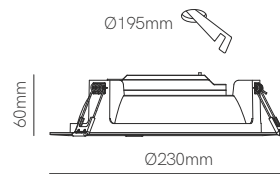
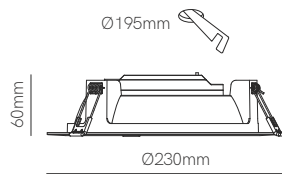

Technical Information

| | | |
|-------------------|---------------------------------|---|
| Version | Air switch | Air |
| Power | 22W | 22W |
| Installation | Recessed | Recessed |
| Color Temperature | Switch 2.700K / 3.200K / 4.000K | 3.000K / 4.000K |
| Lumens | 2.200 lm | 1.760 lm / 1.870 lm |
| Material | Polybutylene and Polycarbonate | Polybutylene and Polycarbonate |
| Finishes | White | White |
| Code | 5018 <input type="checkbox"/> | 300335C3 <input type="checkbox"/> 3.000K 300335F <input type="checkbox"/> 4.000K |

100/277 VAC | CCT SWITCH

220/240 VAC

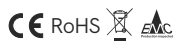

3 YEARS WARRANTY | 25.000 HOURS | IP 40 | PF >0,9 | CRI ≥80 | 100° | 50/60 Hz | +40°C / -20°C | 1/6



New

Noi switch

Noi

Noi dimmable

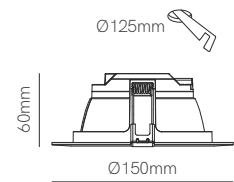
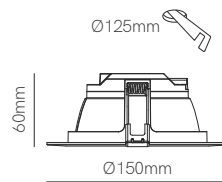
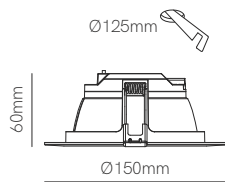

Technical Information

| | | | |
|-------------------|---------------------------------|---|--|
| Version | Noi switch | Noi | Noi dimmable |
| Power | 14W | 14W | 14W |
| Installation | Recessed | Recessed | Recessed |
| Color Temperature | Switch 2.700K / 3.200K / 4.000K | 3.000K / 4.000K | 3.000K / 4.000K |
| Lumens | 1.320 lm | 1.100 lm / 1.320 lm | 1.100 lm / 1.320 lm |
| Material | Polybutylene and Polycarbonate | Polybutylene and Polycarbonate | Polybutylene and Polycarbonate |
| Finishes | White | White | White |
| Code | 5019 <input type="checkbox"/> | 242337-15C3 <input type="checkbox"/> 3.000K 242337-15F <input type="checkbox"/> 4.000K | 3485 <input type="checkbox"/> 3.000K 3486 <input type="checkbox"/> 4.000K |

100/277 VAC

220/240 VAC

220/240 VAC



3 YEARS WARRANTY | 25.000 HOURS | IP 40 | PF >0,9 | CRI ≥80 | | 100° | 50/60 Hz | | +40°C / -20°C | 1/6



Compac round

Compac square

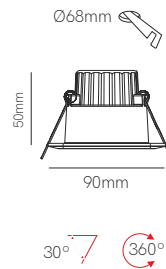
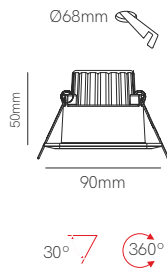

Technical Information

| Version | Compac round | Compac square |
|-------------------|--|--|
| Power | 8W | 8W |
| Installation | Recessed | Recessed |
| Color Temperature | 2.700K / 3.000K / 4.000K | 2.700K / 3.000K / 4.000K |
| Lumens | 594 lm / 607 lm / 660 lm | 594 lm / 607 lm / 660 lm |
| Material | Polybutylene and Polycarbonate | Polybutylene and Polycarbonate |
| Finishes | White | White |
| Code | 3951 <input type="checkbox"/> 2.700K 3952 <input type="checkbox"/> 3.000K 3953 <input type="checkbox"/> 4.000K | 3948 <input type="checkbox"/> 2.700K 3949 <input type="checkbox"/> 3.000K 3950 <input type="checkbox"/> 4.000K |

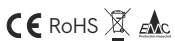

3 YEARS WARRANTY | 25.000 HOURS | IP 44 | 220/240 VAC | PF >0,5 | CRI ≥80 | 90° | 50/60 Hz | TRIAC DIMM | +40°C / -20°C | 1/6/30





Industrial lighting

388. Ufo Lens
399. Ufo

Ufo Lens 100W

Ufo Lens 150W



Technical Information

| Version | Ufo Lens 100W | Ufo Lens 150W |
|-------------------|--------------------------------|--------------------------------|
| Power | 100W | 150W |
| Installation | Surface | Surface |
| Color Temperature | 4.000K / 5.000K | 4.000K / 5.000K |
| Lumens | 16.000 lm / 16.200 lm | 24.000 lm / 24.200 lm |
| Material | Aluminium | Aluminium |
| Finishes | Black | Black |
| Code | 4502 ■ 4.000K 4503 ■ 5.000K | 4504 ■ 4.000K 4505 ■ 5.000K |

Accessories

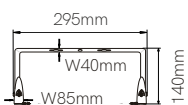

Lira 100W/150W/200W
■ 4566

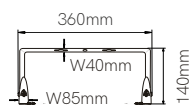

Lira 240W
■ 4567

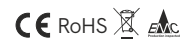

5 YEARS WARRANTY | 50.000 HOURS | IP 65 | 100/260 VAC | PF >0,9 | CRI ≥80 | CABLE 2M | 60° 90° 120° | 50/60 Hz | IK10 | +50°C -30°C | >4KV | 1

Ufo Lens 200W

Ufo Lens 240W



Technical Information

| Version | Ufo Lens 200W | Ufo Lens 240W |
|-------------------|--------------------------------|---------------|
| Power | 200W | 240W |
| Installation | Surface | Surface |
| Color Temperature | 4.000K / 5.000K | 4.000K |
| Lumens | 32.000 lm / 32.200 lm | 38.400 lm |
| Material | Aluminium | Aluminium |
| Finishes | Black | Black |
| Code | 4506 ■ 4.000K 4507 ■ 5.000K | 4508 ■ 4.000K |

Accessories

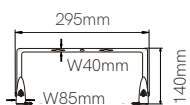

Lira 100W/150W/200W
■ 4566

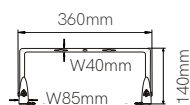

Lira 240W
■ 4567



5 YEARS WARRANTY | 50.000 HOURS | IP 65 | 100/260 VAC | PF >0,9 | CRI ≥80 | CABLE 2M | 60°/90°/120° | 50/60 Hz | IK10 | +50°C / -30°C | >4KV | 1

Ufo Lens





Ufo Lens is an industrial LED bell with 100W, 150W, 200W and 240W power. It is ideal for lighting industrial spaces or warehouses thanks to its optimal resistance to impacts, which is so necessary in this type of spaces.

Ufo Lens allows to change the light beam between 60°, 90° and 120° with a simple twist on the front part, thus being very versatile and adapting to the requirements of the space. Extruded in aluminum and polycarbonate with black finishes, it reaches a real light output of 160Lm/W and two color temperatures, 4000K and 5000K.

This industrial led bell has a protection index against impacts of objects of up to 5 Kg thrown at more than 400 meters, and a protection index that makes it dust-tight and resistant to projected water jets. It is a product with a protection system against overvoltages >4 KV with a driver that works at multivoltage. The Ufo Lens industrial bell has all European regulations and SAA regulations, thus allowing it to be marketed in Oceania.

Ufo Lens es una campana led industrial de 100W, 150W, 200W y 240W de potencia. Ideal para iluminar espacios industriales o almacenes gracias a su óptima resistencia ante impactos, tan necesaria en este tipo de espacios.

UFO Lens permite, con un simple giro en la parte frontal, cambiar los grados de apertura entre 60°, 90° y 120° siendo así muy polivalente y adaptándose a los requerimientos del espacio. Extrusionada en aluminio y policarbonato con acabados en negro, alcanza un rendimiento lumínico de 160Lm/W reales y dos temperaturas de color, 4.000K y 5.000K.

Esta campana led industrial cuenta con un índice de protección contra impactos de objetos de hasta 5 Kg lanzados a más de 400 metros, y un índice de protección que la hace hermética al polvo y resistente a chorros de agua proyectada. Se trata de un producto con un sistema de protección contra sobretensiones >4 KV con un driver que funciona a multitensión. La campana led industrial Ufo Lens cuenta con todas las normativas Europeas y con la normativa SAA permitiendo así su comercialización en Oceanía.

Ufo Lens Dali 100W

Ufo Lens Dali 150W



Technical Information

| | | |
|-------------------|--------------------------------|--------------------------------|
| Version | Ufo Lens Dali 100W | Ufo Lens Dali 150W |
| Power | 100W | 150W |
| Installation | Surface | Surface |
| Color Temperature | 4.000K / 5.000K | 4.000K / 5.000K |
| Lumens | 16.000 lm / 16.200 lm | 24.000 lm / 24.200 lm |
| Material | Aluminium | Aluminium |
| Finishes | Black | Black |
| Code | 4915 ■ 4.000K 4916 ■ 5.000K | 4917 ■ 4.000K 4918 ■ 5.000K |

Accessories

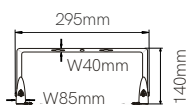

Lira 100W/150W/200W
■ 4566

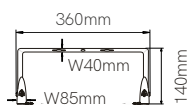

Lira 240W
■ 4567

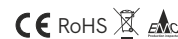

5 YEARS WARRANTY | 50.000 HOURS | IP 65 | 100/260 VAC | PF >0,9 | CRI ≥80 | CABLE 2M | 60°/90°/120° | 50/60 Hz | IK10 | +50°C / -30°C | >4KV | DALI2 | 1

Ufo Lens Dali 200W

Ufo Lens Dali 240W



Technical Information

| | | |
|-------------------|--------------------------------|--------------------|
| Version | Ufo Lens Dali 200W | Ufo Lens Dali 240W |
| Power | 200W | 240W |
| Installation | Surface | Surface |
| Color Temperature | 4.000K / 5.000K | 4.000K |
| Lumens | 32.000 lm / 32.200 lm | 38.400 lm |
| Material | Aluminium | Aluminium |
| Finishes | Black | Black |
| Code | 4919 ■ 4.000K 4920 ■ 5.000K | 4921 ■ 4.000K |

Accessories

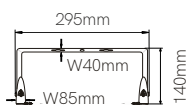

Lira 100W/150W/200W
■ 4566

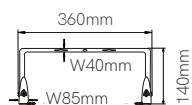

Lira 240W
■ 4567

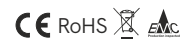

5 YEARS WARRANTY | 50.000 HOURS | IP 65 | 100/260 VAC | PF >0,9 | CRI ≥80 | CABLE 2M | 60°/90°/120° | 50/60 Hz | IK10 | +50°C / -30°C | >4KV | DALI | 1

Light output

60°



Ufo lens 100W

| | | |
|----------|--------|-------|
| 1m | 5m | 11m |
| 9.113 lx | 365 lx | 75 lx |

Ufo lens 150W

| | | |
|-----------|--------|-------|
| 1m | 7m | 14m |
| 13.670 lx | 279 lx | 70 lx |

Ufo lens 200W

| | | |
|-----------|--------|-------|
| 1m | 8m | 16m |
| 18.226 lx | 225 lx | 71 lx |

Ufo lens 240W

| | | |
|-----------|--------|-------|
| 1m | 9m | 19m |
| 26.635 lx | 329 lx | 74 lx |



90°



| | | |
|----------|--------|-------|
| 1m | 5m | 10m |
| 7.867 lx | 315 lx | 79 lx |

| | | |
|-----------|--------|-------|
| 1m | 6m | 13m |
| 11.800 lx | 328 lx | 70 lx |

| | | |
|-----------|--------|-------|
| 1m | 7m | 15m |
| 15.733 lx | 321 lx | 70 lx |

| | | |
|-----------|--------|-------|
| 1m | 9m | 19m |
| 26.654 lx | 292 lx | 73 lx |

120°



| | | |
|----------|--------|-------|
| 1m | 5m | 10m |
| 6.638 lx | 266 lx | 66 lx |

| | | |
|----------|--------|-------|
| 1m | 6m | 12m |
| 9.956 lx | 277 lx | 69 lx |

| | | |
|-----------|--------|-------|
| 1m | 7m | 14m |
| 13.275 lx | 271 lx | 68 lx |

| | | |
|-----------|--------|-------|
| 1m | 9m | 19m |
| 15.882 lx | 324 lx | 68 lx |







Light output

| 1m | 7m | 14m |
|-----------|--------|------|
| 14.401 lx | 294 lx | 73lx |

Ufo 300W

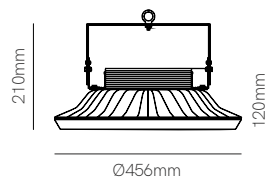

Technical Information

| | |
|-------------------|---|
| Version | Ufo 300W |
| Power | 300W |
| Installation | Surface |
| Color Temperature | 4.000K |
| Lumens | 39.000 lm |
| Material | Aluminium |
| Finishes | Black |
| Code | 3972 4.000K |



*Lira included.

5 YEARS WARRANTY |
 50.000 HOURS |
 IP 65 |
 100/260 VAC |
 PF >0,9 |
 CRI ≥80 |
 |
 CABLE 2M |
 110° |
 50/60 Hz |
 IK10 |
 +50°C -30°C |
 >4KV |
 1

Outdoor lighting

403. Mac
407. Tura
409. Clos
415. Comet
419. Cam
421. Neo
429. Sigma
431. Signal
435. Sunset
439. Lek
445. Blis
449. Selen
451. Zibor
452. Optic, Nix
453. Ina, Dis
457. Polo
459. Luky
461. Mis
465. Artis
467. Nik
469. Visor
471. Fix
473. Sair
475. Caddie
477. Fade
479. Zas
481. Sky
486. Sky sensor
491. Sky 2.200K
493. Polaris
495. Krion
497. Wech



Mac 30

Mac 60

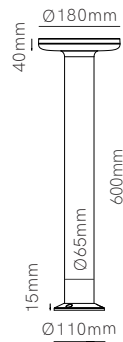
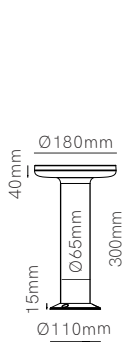

Technical Information

| | | |
|-------------------|-----------------------------|-----------------------------|
| Version | Mac 30 | Mac 60 |
| Power | 12W | 12W |
| Installation | Floor | Floor |
| Color Temperature | 3.000K / 4.000K | 3.000K / 4.000K |
| Lumens | 890 lm / 900 lm | 890 lm / 900 lm |
| Material | Aluminium and Polycarbonate | Aluminium and Polycarbonate |
| Finishes | White / Black / Corten | White / Black / Corten |

| | | | | | | | |
|------|------|-------------------------------------|--------|------|--------------------------|-------------------------------------|--------|
| Code | 4837 | <input type="checkbox"/> | 3.000K | 4843 | <input type="checkbox"/> | 3.000K | |
| | 4838 | <input type="checkbox"/> | 4.000K | | 4844 | <input type="checkbox"/> | 4.000K |
| | 4839 | <input checked="" type="checkbox"/> | 3.000K | | 4845 | <input checked="" type="checkbox"/> | 3.000K |
| | 4840 | <input checked="" type="checkbox"/> | 4.000K | | 4846 | <input checked="" type="checkbox"/> | 4.000K |
| | 4841 | <input checked="" type="checkbox"/> | 3.000K | | 4847 | <input checked="" type="checkbox"/> | 3.000K |
| | 4842 | <input checked="" type="checkbox"/> | 4.000K | | 4848 | <input checked="" type="checkbox"/> | 4.000K |

1/12

1/6

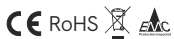

3 YEARS WARRANTY | 30.000 HOURS | IP 65 | 220/240 VAC | PF >0,9 | CRI ≥80 | 100° | 50/60 Hz | IK06 | +50°C / -20°C







Tura 30

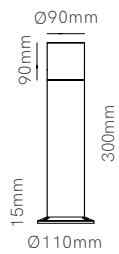

Tura 60

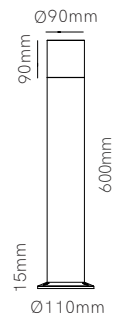

Technical Information

| | | |
|-------------------|----------------------------|----------------------------|
| Version | Tura 30 | Tura 60 |
| Power | 12W | 12W |
| Installation | Floor | Floor |
| Color Temperature | 3.000K / 4.000K | 3.000K / 4.000K |
| Lumens | 950 lm / 960 lm | 950 lm / 960 lm |
| Material | Aluminium and Methacrylate | Aluminium and Methacrylate |
| Finishes | White / Black / Corten | White / Black / Corten |

| | | | | | | | |
|------|------|-------------------------------------|--------|------|--------------------------|-------------------------------------|--------|
| Code | 4849 | <input type="checkbox"/> | 3.000K | 4855 | <input type="checkbox"/> | 3.000K | |
| | 4850 | <input type="checkbox"/> | 4.000K | | 4856 | <input type="checkbox"/> | 4.000K |
| | 4851 | <input checked="" type="checkbox"/> | 3.000K | | 4857 | <input checked="" type="checkbox"/> | 3.000K |
| | 4852 | <input checked="" type="checkbox"/> | 4.000K | | 4858 | <input checked="" type="checkbox"/> | 4.000K |
| | 4853 | <input checked="" type="checkbox"/> | 3.000K | | 4859 | <input checked="" type="checkbox"/> | 3.000K |
| | 4854 | <input checked="" type="checkbox"/> | 4.000K | | 4860 | <input checked="" type="checkbox"/> | 4.000K |

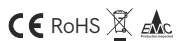

3 YEARS WARRANTY | 30.000 HOURS | IP 65 | 220/240 VAC | PF >0,9 | CRI ≥80 | 180° | 50/60 Hz | IK06 | +50°C / -20°C



Clos 8W

Clos 16W

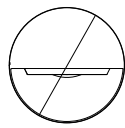

Ø200mm



38mm

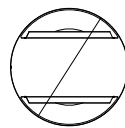

Ø200mm



38mm



Technical Information

| Version | Clos 8W | Clos 16W |
|-------------------|---------------------------------|---------------------------------|
| Power | 8W | 16W |
| Installation | Surface / Floor | Surface / Floor |
| Color Temperature | Switch 3.000K / 4.000K / 5.000K | Switch 3.000K / 4.000K / 5.000K |
| Lumens | 1.000 lm | 2.100 lm |
| Material | Aluminium and polycarbonate | Aluminium and polycarbonate |
| Finishes | White / Black / Corten | White / Black / Corten |

| Code | Clos 8W | Clos 16W |
|------|--|--|
| | 4876 <input type="checkbox"/> | 4879 <input type="checkbox"/> |
| | 4877 <input checked="" type="checkbox"/> | 4880 <input checked="" type="checkbox"/> |
| | 4878 <input checked="" type="checkbox"/> | 4881 <input checked="" type="checkbox"/> |

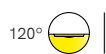

*Accessories (pages 410 and 411).

5 YEARS WARRANTY | 50.000 HOURS | IP 65 | 175/265 VAC | PF >0,9 | CRI ≥80 | 50/60 Hz | IK08 | +40°C / -25°C | CCT SWITCH | 1/20

Clos 8W base 30cm

Clos 16W base 30cm

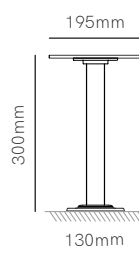
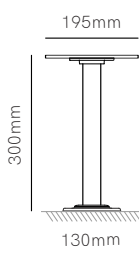

Technical Information

| | | |
|--------------|-------------------------------|-------------------------------|
| Version | Clos 8W base 30cm | Clos 16W base 30cm |
| Installation | Surface / Floor | Surface / Floor |
| Material | Aluminium | Aluminium |
| Finishes | White / Black / Corten | White / Black / Corten |
| Code | 4882 <input type="checkbox"/> | 4888 <input type="checkbox"/> |
| | 4883 <input type="checkbox"/> | 4889 <input type="checkbox"/> |
| | 4884 <input type="checkbox"/> | 4890 <input type="checkbox"/> |



*Need Clos (page 409).

Clos 8W base 60cm

Clos 16W base 60cm

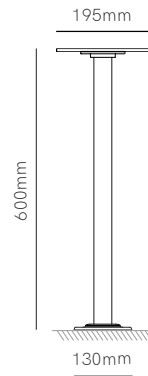
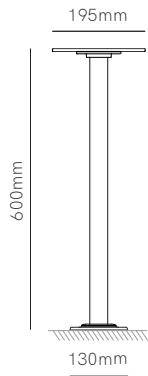

Technical Information

| | | |
|--------------|-------------------------------|-------------------------------|
| Version | Clos 8W base 60cm | Clos 16W base 60cm |
| Installation | Surface / Floor | Surface / Floor |
| Material | Aluminium | Aluminium |
| Finishes | White / Black / Corten | White / Black / Corten |
| Code | 4885 <input type="checkbox"/> | 4891 <input type="checkbox"/> |
| | 4886 <input type="checkbox"/> | 4892 <input type="checkbox"/> |
| | 4887 <input type="checkbox"/> | 4893 <input type="checkbox"/> |



*Need Clos (page 409).









Comet switch

Comet

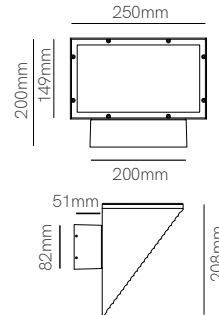
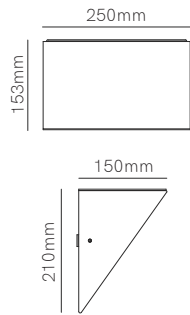

Technical Information

| | | |
|-------------------|---------------------------------|---------------|
| Version | Comet switch | Comet |
| Power | Switch 20W / 40W | 40W |
| Installation | Surface | Surface |
| Color Temperature | Switch 2.700K / 3.200K / 4.000K | 5.000K |
| Lumens | 20W: 2.500 lm / 40W: 5.000 lm | 4.071 lm |
| Material | Aluminium | Aluminium |
| Finishes | White / Black / Corten | White / Black |

| | | |
|------|--|---|
| Code | 5073 <input type="checkbox"/> | 243113-5N <input checked="" type="checkbox"/> |
| | 5074 <input checked="" type="checkbox"/> | |
| | 5112 <input checked="" type="checkbox"/> | |

30.000 HOURS | 40°x90° | | 1/6

CCT SWITCH | POWER SWITCH | IK10 | AKZO NOBEL

30.000 HOURS | 100° | | 1/4

IK08



3 YEARS WARRANTY | IP 65 | 220/240 VAC | PF >0,9 | CRI ≥80 | | 50/60 Hz | +45°C / -25°C | TRIAC DIMM

Mini comet switch

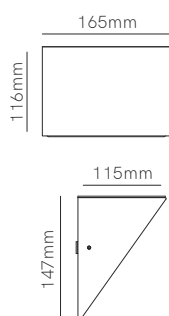

Technical Information

| | |
|-------------------|--|
| Version | Mini comet switch |
| Power | Switch 10W / 20W |
| Installation | Surface |
| Color Temperature | Switch 2.700K / 3.200K / 4.000K |
| Lumens | 10W: 1.250 lm / 20W 2.400 lm |
| Material | Aluminium |
| Finishes | White / Black / Corten |
| Code | 5075 <input type="checkbox"/> |
| | 5076 <input checked="" type="checkbox"/> |
| | 5113 <input type="checkbox"/> |

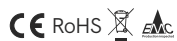

3 YEARS WARRANTY | 30.000 HOURS | IP 65 | 220/240 VAC | PF >0,9 | CRI ≥80 | 40°x90° | 50/60 Hz | IK10 | +45°C / -25°C | AKZO NOBEL | CCT SWITCH | POWER SWITCH | TRIAC DIMM | 1/16





Cam 60

Cam 110

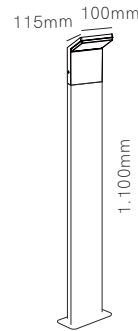
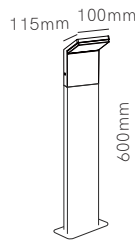

Technical Information

| | | |
|-------------------|-----------------|-----------------|
| Version | Cam 60 | Cam 110 |
| Power | 9W | 9W |
| Installation | Floor | Floor |
| Color Temperature | 3.000K / 4.000K | 3.000K / 4.000K |
| Lumens | 690 lm / 700 lm | 690 lm / 700 lm |
| Material | Aluminium | Aluminium |
| Finishes | White / Black | White / Black |

| | | | | | | | | |
|------|------|-------------------------------------|--------|-----|------|-------------------------------------|--------|-----|
| Code | 4709 | <input type="checkbox"/> | 3.000K | 1/4 | 3751 | <input type="checkbox"/> | 3.000K | 1/2 |
| | 3586 | <input type="checkbox"/> | 4.000K | | 3752 | <input type="checkbox"/> | 4.000K | |
| | 4710 | <input checked="" type="checkbox"/> | 3.000K | | 3753 | <input checked="" type="checkbox"/> | 3.000K | |
| | 3590 | <input checked="" type="checkbox"/> | 4.000K | | 3754 | <input checked="" type="checkbox"/> | 4.000K | |



3 YEARS WARRANTY | 25.000 HOURS | IP 54 | 220/240 VAC | PF >0,7 | CRI ≥80 | 120° | 50 Hz | IK08 | +45°C / -25°C



Neo

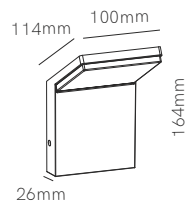

Technical Information

| | |
|-------------------|-----------------|
| Version | Neo |
| Power | 9W |
| Installation | Surface |
| Color Temperature | 3.000K / 4.000K |
| Lumens | 690 lm / 700 lm |
| Material | Aluminium |
| Finishes | White / Black |

| | | | |
|------|------|-------------------------------------|--------|
| Code | 3747 | <input type="checkbox"/> | 3.000K |
| | 3748 | <input type="checkbox"/> | 4.000K |
| | 3749 | <input checked="" type="checkbox"/> | 3.000K |
| | 3750 | <input checked="" type="checkbox"/> | 4.000K |



3 YEARS WARRANTY | 25.000 HOURS | IP 54 | 220/240 VAC | PF >0,7 | CRI ≥80 | | 120° | 50 Hz | | +45°C / -25°C |

Neo XL

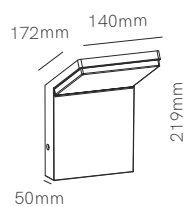

Technical Information

| | |
|-------------------|--|
| Version | Neo XL |
| Power | 18W |
| Installation | Surface |
| Color Temperature | 3.000K / 4.000K |
| Lumens | 1.640 lm / 1.650 lm |
| Material | Aluminium |
| Finishes | White / Black |
| Code | 3890 <input type="checkbox"/> 3.000K 3891 <input type="checkbox"/> 4.000K 3892 <input checked="" type="checkbox"/> 3.000K 3893 <input checked="" type="checkbox"/> 4.000K |

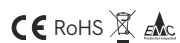

3 YEARS WARRANTY | 25.000 HOURS | IP 65 | 100/240 VAC | PF >0,9 | CRI ≥80 | | 120° | 50 Hz | IK08 | +45°C / -25°C | 1/4



Neo sensor

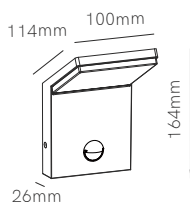

Technical Information

| | |
|-------------------|-----------------|
| Version | Neo sensor |
| Power | 9W |
| Installation | Surface |
| Color Temperature | 3.000K / 4.000K |
| Lumens | 690 lm / 700 lm |
| Material | Aluminium |
| Finishes | White / Black |

| | | | |
|------|------|-------------------------------------|--------|
| Code | 3585 | <input type="checkbox"/> | 3.000K |
| | 3583 | <input type="checkbox"/> | 4.000K |
| | 3584 | <input checked="" type="checkbox"/> | 3.000K |
| | 3582 | <input checked="" type="checkbox"/> | 4.000K |

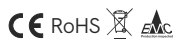

3 YEARS WARRANTY | 25.000 HOURS | IP 54 | 220/240 VAC | PF >0,7 | CRI ≥80 | 120° | 50 Hz | IK08 | +45°C / -25°C | PIR SENSOR | ON OFF | 8 sec 8 min | 1/12



Neo XL sensor

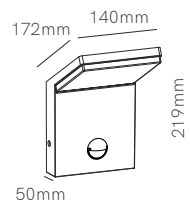

Technical Information

| | |
|-------------------|--|
| Version | Neo XL sensor |
| Power | 18W |
| Installation | Surface |
| Color Temperature | 3.000K / 4.000K |
| Lumens | 1.640 lm / 1.650 lm |
| Material | Aluminium |
| Finishes | White / Black |
| Code | 3886 <input type="checkbox"/> 3.000K 3887 <input type="checkbox"/> 4.000K 3888 <input checked="" type="checkbox"/> 3.000K 3889 <input checked="" type="checkbox"/> 4.000K |







Sigma 3W



Sigma 17W

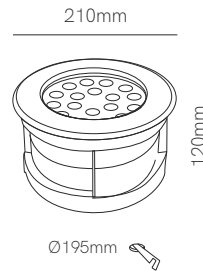

Technical Information

| | | |
|-------------------|---------------|---------------|
| Version | Sigma 3W | Sigma 17W |
| Power | 3W | 17W |
| Installation | Recessed | Recessed |
| Color Temperature | 3.000K | 3.000K |
| Lumens | 210 lm | 1.440 lm |
| Material | Aluminium | Aluminium |
| Finishes | Brushed | Brushed |
| Code | 4251 ■ 3.000K | 4135 ■ 3.000K |

PF >0,6 |

PF >0,9 |

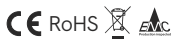

*Integrated driver. Drainage (min. 300mm).

|
 |
 |
 |
 |
 |
 |
 |
 |
 |
 |



Signal

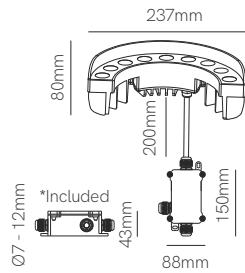

Technical Information

| | |
|-------------------|--------------------|
| Version | Signal |
| Power | 9W |
| Installation | Floor / Tree trunk |
| Color Temperature | 3.000K |
| Lumens | 720 lm |
| Material | Aluminium |
| Finishes | Dark gray |
| Code | 4290 ■ 3.000K |



*Integrated driver. IP65 connection box included.

3 YEARS WARRANTY | 20.000 HOURS | IP 65 | 100/277 VAC | PF >0,6 | CRI ≥80 | CABLE 20CM | 30° | 50/60 Hz | IK05 | +40°C / -20°C | 1/25

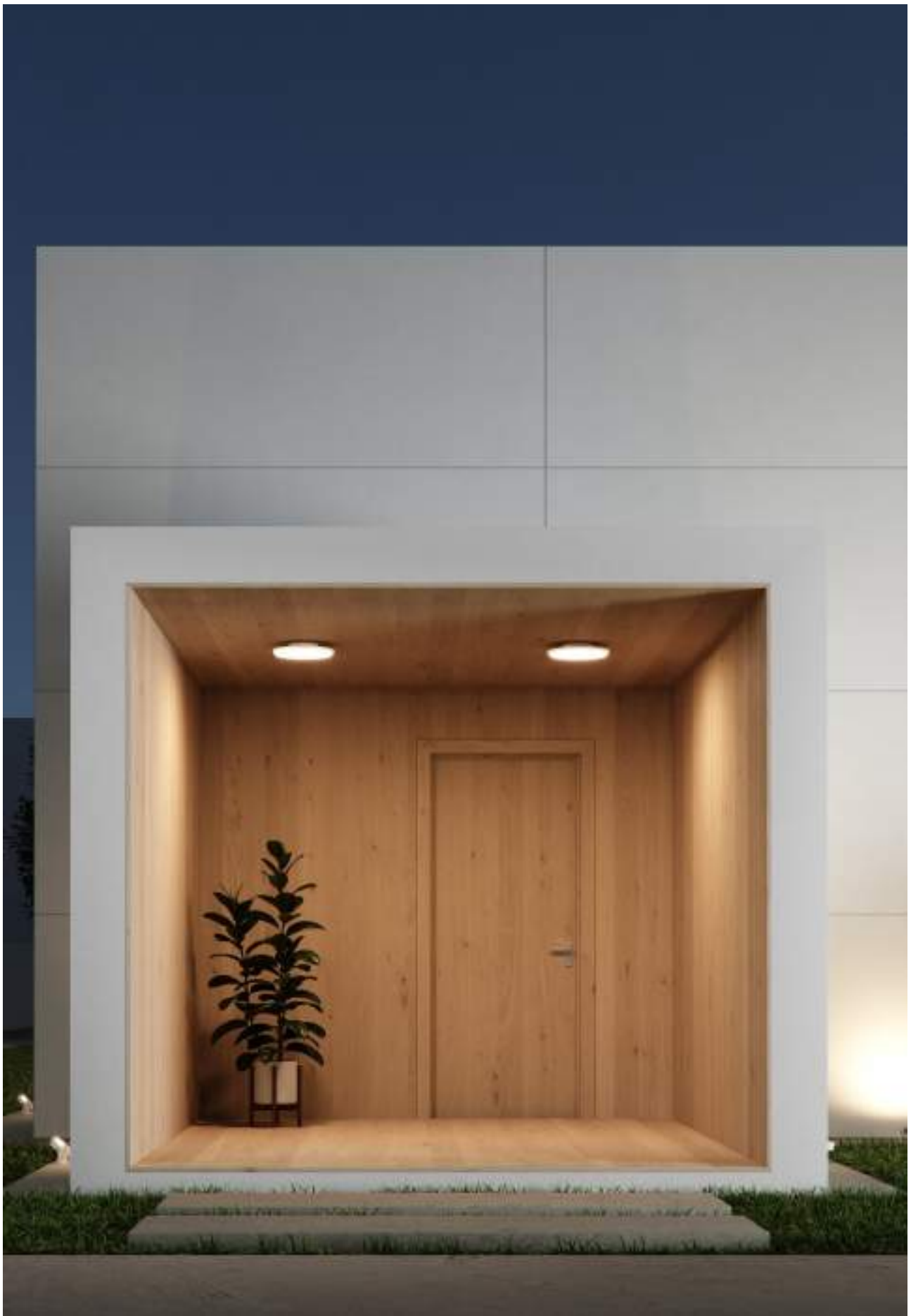

Gadir

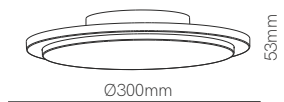

Technical Information

| | |
|-------------------|---------------------|
| Version | Gadir |
| Power | 18W |
| Installation | Surface |
| Color Temperature | 3.000K / 4.000K |
| Lumens | 1.400 lm / 1.500 lm |
| Material | Aluminium |
| Finishes | White / Black |

| | | | |
|------|------|-------------------------------------|--------|
| Code | 3758 | <input type="checkbox"/> | 3.000K |
| | 3589 | <input type="checkbox"/> | 4.000K |
| | 3757 | <input checked="" type="checkbox"/> | 3.000K |
| | 3593 | <input checked="" type="checkbox"/> | 4.000K |



3 YEARS WARRANTY | 25.000 HOURS | IP 65 | 100/240 VAC | PF >0,9 | CRI ≥80 | | 120° | 50 Hz | IK08 | +45°C / -25°C | 1/4



New

Sunset round

Sunset square

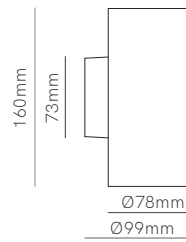
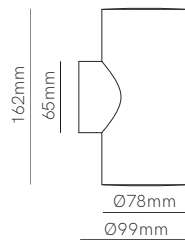

Technical Information

| Version | Sunset round | Sunset square |
|-------------------|---|---|
| Power | 16W | 16W |
| Installation | Surface | Surface |
| Color Temperature | Switch 2.700K / 3.200K / 4.000K | Switch 2.700K / 3.200K / 4.000K |
| Lumens | 1.800 lm | 1.800 lm |
| Material | Polycarbonate | Polycarbonate |
| Finishes | White / Black / Corten | White / Black / Corten |
| Code | 4989 <input type="checkbox"/> 4990 <input checked="" type="checkbox"/> 4991 <input checked="" type="checkbox"/> | 4992 <input type="checkbox"/> 4993 <input checked="" type="checkbox"/> 4994 <input checked="" type="checkbox"/> |

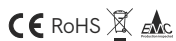

3 YEARS WARRANTY | 25.000 HOURS | IP 65 | 220/240 VAC | PF >0,9 | CRI ≥80 | 40° | 50/60 Hz | IK06 | +40°C / -20°C | CCT SWITCH | 1/10

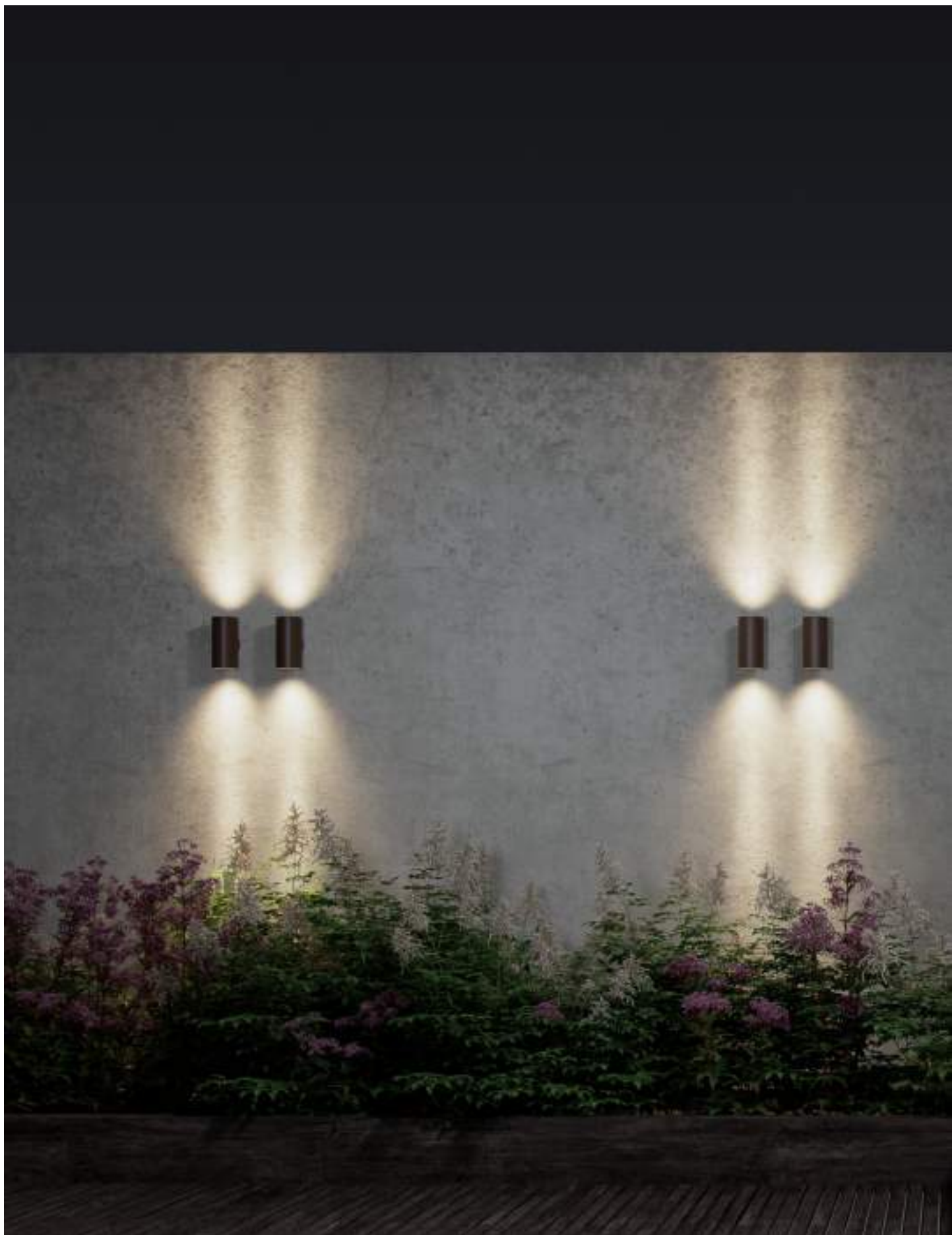





Lek round

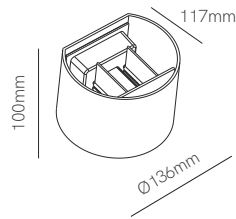

Lek square

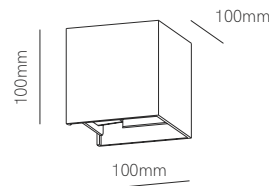

Technical Information

| Version | Lek round | Lek square |
|-------------------|--------------------------|--------------------------|
| Power | 6,8W | 6,8W |
| Installation | Surface | Surface |
| Color Temperature | 2.700K / 3.000K / 4.000K | 2.700K / 3.000K / 4.000K |
| Lumens | 480 lm / 530 lm / 542 lm | 480 lm / 530 lm / 542 lm |
| Material | Aluminium | Aluminium |
| Finishes | White / Black / Corten | White / Black / Corten |

| Code | Lek round | Lek square |
|------|-----------|---------------|
| 4906 | □ 2.700K | 4303 □ 2.700K |
| 4907 | □ 3.000K | 3983 □ 3.000K |
| 4908 | □ 4.000K | 3984 □ 4.000K |
| 4909 | ■ 2.700K | 4304 ■ 2.700K |
| 4910 | ■ 3.000K | 3985 ■ 3.000K |
| 4911 | ■ 4.000K | 3986 ■ 4.000K |
| 4912 | ■ 2.700K | 4312 ■ 2.700K |
| 4913 | ■ 3.000K | 3987 ■ 3.000K |
| 4914 | ■ 4.000K | 3988 ■ 4.000K |



3 YEARS WARRANTY | 30.000 HOURS | IP 54 | 220/240 VAC | PF >0,9 | CRI ≥80 | 0°-120° | 50/60 Hz | IK04 | +40°C / -10°C | AKZO NOBEL | 1/12

New

Lek XL round

Lek XL square

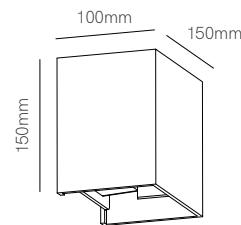
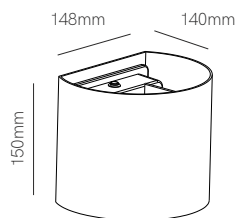

Technical Information

| Version | Lek XL round | Lek XL square |
|-------------------|---|---|
| Power | 20W | 20W |
| Installation | Surface | Surface |
| Color Temperature | Switch 2.700K / 3.200K / 4.000K | Switch 2.700K / 3.200K / 4.000K |
| Lumens | 1.680 lm | 1.680 lm |
| Material | Aluminium | Aluminium |
| Finishes | White / Black / Corten | White / Black / Corten |
| Code | 5081 <input type="checkbox"/> 5082 <input checked="" type="checkbox"/> 5083 <input checked="" type="checkbox"/> | 5078 <input type="checkbox"/> 5079 <input checked="" type="checkbox"/> 5080 <input checked="" type="checkbox"/> |



3 YEARS WARRANTY | 30.000 HOURS | IP 65 | 220/240 VAC | PF >0,9 | CRI ≥80 | 0°-100° | 50/60 Hz | IK04 | +45°C / -20°C | CCT SWITCH | AKZO NOBEL | 1/12









New

Blis round

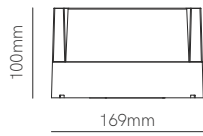

Blis square

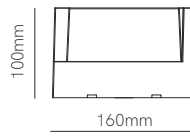

Blis rectangular

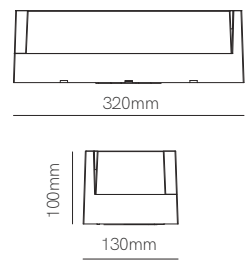

Technical Information

| Version | Blis round | Blis square | Blis rectangular |
|-------------------|---------------------------------|---------------------------------|---------------------------------|
| Power | 15W | 15W | 24W |
| Installation | Surface | Surface | Surface |
| Color Temperature | Switch 2.700K / 3.200K / 4.000K | Switch 2.700K / 3.200K / 4.000K | Switch 2.700K / 3.200K / 4.000K |
| Lumens | 1.470 lm | 1.370 lm | 2.360 lm |
| Material | Polycarbonate | Polycarbonate | Polycarbonate |
| Finishes | White / Black / Corten | White / Black / Corten | White / Black / Corten |

| Code | Blis round | Blis square | Blis rectangular |
|------|--|--|--|
| | 4957 <input type="checkbox"/> | 4960 <input type="checkbox"/> | 4982 <input type="checkbox"/> |
| | 4958 <input checked="" type="checkbox"/> | 4961 <input checked="" type="checkbox"/> | 4983 <input checked="" type="checkbox"/> |
| | 4959 <input checked="" type="checkbox"/> | 4962 <input checked="" type="checkbox"/> | 4984 <input checked="" type="checkbox"/> |

PF >0,6 | 250°

PF >0,6 | 180°

PF >0,9 | 180°

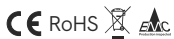

*IP65 connection box included.

3 YEARS WARRANTY | 25.000 HOURS | IP 65 | 220/240 VAC | CRI ≥80 | | 50/60 Hz | | +40°C / -20°C | CCT SWITCH |







Selen

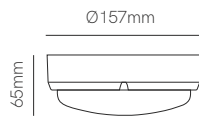

Technical Information

| | |
|-------------------|---------------------|
| Version | Selen |
| Power | 12W |
| Installation | Surface |
| Color Temperature | 3.000K / 4.000K |
| Lumens | 1.200 lm / 1.250 lm |
| Material | Polycarbonate |
| Finishes | White / Black |

| | | | |
|------|------|-------------------------------------|--------|
| Code | 4668 | <input type="checkbox"/> | 3.000K |
| | 4667 | <input type="checkbox"/> | 4.000K |
| | 4828 | <input checked="" type="checkbox"/> | 3.000K |
| | 4827 | <input checked="" type="checkbox"/> | 4.000K |



3 YEARS WARRANTY | 25.000 HOURS | IP 65 | 220/240 VAC | PF >0,9 | CRI ≥80 | 120° | 50/60 Hz | IK02 | +40°C / -20°C | 1/10

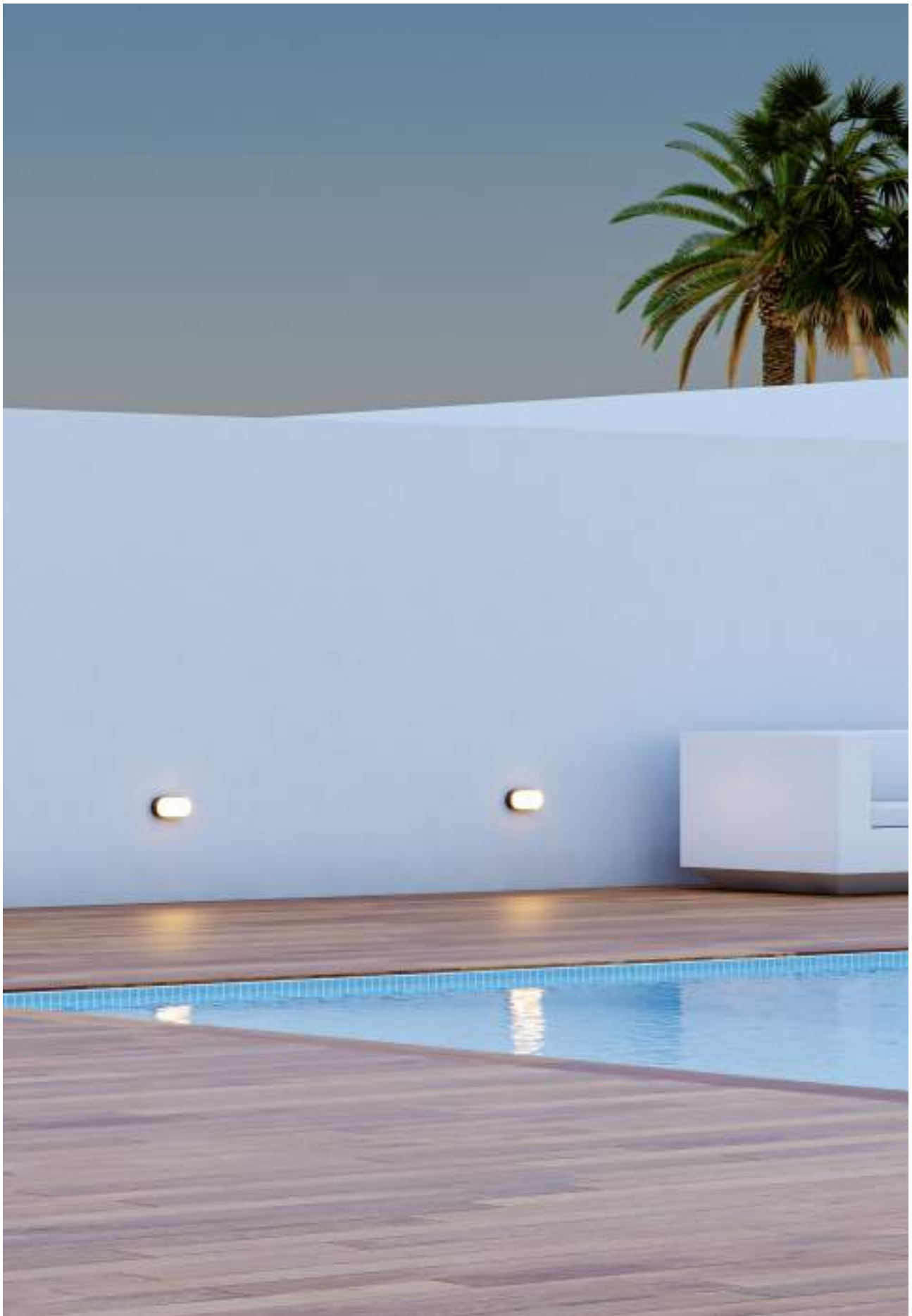

Zibor

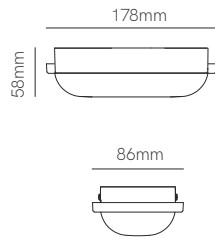

Technical Information

| | |
|-------------------|---------------------|
| Version | Zibor |
| Power | 12W |
| Installation | Surface |
| Color Temperature | 3.000K / 4.000K |
| Lumens | 1.200 lm / 1.250 lm |
| Material | Polycarbonate |
| Finishes | White / Black |

| | | | |
|------|------|-------------------------------------|--------|
| Code | 4670 | <input type="checkbox"/> | 3.000K |
| | 4669 | <input type="checkbox"/> | 4.000K |
| | 4830 | <input checked="" type="checkbox"/> | 3.000K |
| | 4829 | <input checked="" type="checkbox"/> | 4.000K |



3 YEARS WARRANTY | 25.000 HOURS | IP 65 | 220/240 VAC | PF >0,9 | CRI ≥80 | 120° | 50/60 Hz | IK02 | +40°C / -20°C | 1/10

Optic

Nix

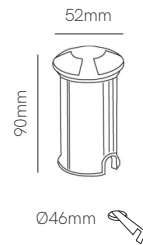
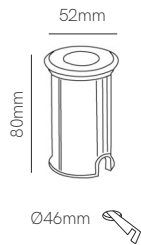

Technical Information

| | | |
|-------------------|--------------|--------------|
| Version | Optic | Nix |
| Power | 2W | 2W |
| Installation | Recessed | Recessed |
| Color Temperature | 3.000K | 3.000K |
| Lumens | 55 lm | 55 lm |
| Material | Inox 304 | Inox 304 |
| Finishes | Brushed Inox | Brushed Inox |
| Code | 4331 ■ | 4369 ■ |

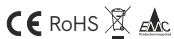

*Recessed box included. Integrated driver.

3 YEARS WARRANTY | 50.000 HOURS | IP 67 | 100/240 VAC | PF >0,4 | CRI ≥80 | | CABLE 50CM | 50/60 Hz | | +50°C -20°C |

Ina

Dis

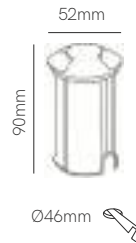
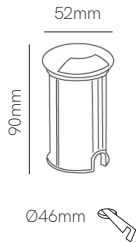

Technical Information

| | | |
|-------------------|--------------|--------------|
| Version | Ina | Dis |
| Power | 2W | 2W |
| Installation | Recessed | Recessed |
| Color Temperature | 3.000K | 3.000K |
| Lumens | 55 lm | 55 lm |
| Material | Inox 304 | Inox 304 |
| Finishes | Brushed Inox | Brushed Inox |
| Code | 4367 ■ | 4368 ■ |



*Recessed box included. Integrated driver.









Showroom Beneito Faure, La Roca del Valles (Spain).

Polo

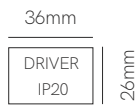
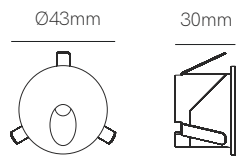

Technical Information

| | |
|-------------------|-----------------|
| Version | Polo |
| Power | 2W |
| Installation | Recessed |
| Color Temperature | 3.200K / 4.000K |
| Lumens | 90 lm / 96 lm |
| Material | Aluminium |
| Finishes | White / Black |

| | |
|------|---|
| Code | 3995 <input type="checkbox"/> 3.200K |
| | 3996 <input type="checkbox"/> 4.000K |
| | 3997 <input checked="" type="checkbox"/> 3.200K |
| | 3998 <input checked="" type="checkbox"/> 4.000K |

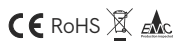

3 YEARS WARRANTY | 50.000 HOURS | IP 54 | 220/240 VAC | PF >0,5 | CRI ≥80 | 65° | 50/60 Hz | +50°C / -20°C | AKZO NOBEL | 1/200



Luky

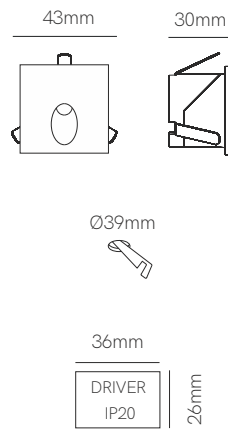

Technical Information

| | |
|-------------------|-----------------|
| Version | Luky |
| Power | 2W |
| Installation | Recessed |
| Color Temperature | 3.200K / 4.000K |
| Lumens | 90 lm / 96 lm |
| Material | Aluminium |
| Finishes | White / Black |

| | | | |
|------|------|-------------------------------------|--------|
| Code | 3999 | <input type="checkbox"/> | 3.200K |
| | 4000 | <input type="checkbox"/> | 4.000K |
| | 4001 | <input checked="" type="checkbox"/> | 3.200K |
| | 4002 | <input checked="" type="checkbox"/> | 4.000K |



3 YEARS WARRANTY | 50.000 HOURS | IP 54 | 220/240 VAC | PF >0,5 | CRI ≥80 | 65° | 50/60 Hz | +50°C / -20°C | AKZO NOBEL | 1/200



New

Mis round switch

Mis round

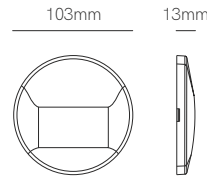
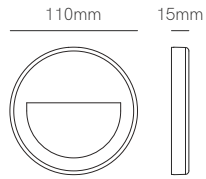

Technical Information

| | | |
|-------------------|--|--|
| Version | Mis round switch | Mis round |
| Power | 3W | 3W |
| Installation | Surface | Surface |
| Color Temperature | Switch 2.700K / 3.200K / 4.000K | 3.000K |
| Lumens | 200 lm | 140 lm |
| Material | Polycarbonate | Polycarbonate |
| Finishes | White / Black / Corten | White / Black / Corten |
| Code | 5020 <input type="checkbox"/> | 4546 <input type="checkbox"/> |
| | 5021 <input checked="" type="checkbox"/> | 4547 <input checked="" type="checkbox"/> |
| | 5022 <input checked="" type="checkbox"/> | 4548 <input checked="" type="checkbox"/> |

CCT SWITCH | PF >0,5

PF >0,9



*Integrated driver.

3 YEARS WARRANTY | 25.000 HOURS | IP 65 | 220/240 VAC | CRI ≥80 | 50/60 Hz | IK06 | +40°C / -20°C | 1/10/50

New

Mis square switch

Mis square

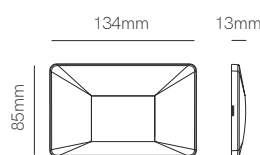
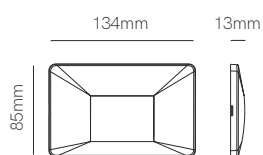

Technical Information

| | | |
|-------------------|--|--|
| Version | Mis square switch | Mis square |
| Power | 3W | 3W |
| Installation | Surface | Surface |
| Color Temperature | Switch 2.700K / 3.200K / 4.000K | 3.000K |
| Lumens | 140 lm | 140 lm |
| Material | Polycarbonate | Polycarbonate |
| Finishes | White / Black / Corten | White / Black / Corten |
| Code | 5023 <input type="checkbox"/> | 4313 <input type="checkbox"/> |
| | 5024 <input checked="" type="checkbox"/> | 4314 <input checked="" type="checkbox"/> |
| | 5025 <input checked="" type="checkbox"/> | 4315 <input checked="" type="checkbox"/> |

CCT SWITCH | PF >0,5

PF >0,9

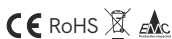

*Integrated driver.

3 YEARS WARRANTY | 25.000 HOURS | IP 65 | 220/240 VAC | CRI ≥80 | | | 50/60 Hz | | +40°C / -20°C | 1/10/50





New

Artis

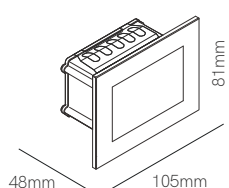

Recessed box included
107mmx73mmx53mm



Surface box included
103mm x 79mm x 57 mm



Technical Information

| | |
|-------------------|---------------------------------|
| Version | Artis |
| Power | 4,5W |
| Installation | Surface / Recessed |
| Color Temperature | Switch 2.700K / 3.200K / 4.000K |
| Lumens | 130 lm |
| Material | Aluminium and glass |
| Finishes | White |
| Code | 5028 <input type="checkbox"/> |

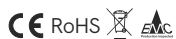

*Recessed and surface box included.

3 YEARS WARRANTY | 25.000 HOURS | IP 66 | 220/240 VAC | PF >0,5 | CRI ≥80 | | 120° | 50/60 Hz | | +50°C / -20°C | CCT SWITCH |



Nik

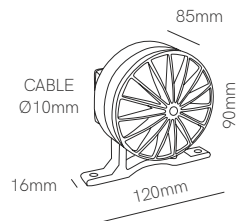

Technical Information

| | |
|-------------------|-----------------|
| Version | Nik |
| Power | 5W |
| Installation | Surface |
| Color Temperature | 3.000K / 4.000K |
| Lumens | 340 lm / 350 lm |
| Material | Aluminium |
| Finishes | Gray |
| Code | 4291 ■ 3.000K |
| | 4292 ■ 4.000K |



*Integrated driver.

3 YEARS WARRANTY | 20.000 HOURS | IP 65 | 100/277 VAC | PF >0,6 | CRI ≥70 | 5° | 50/60 Hz | IK05 | +40°C / -20°C | 1/40



Visor

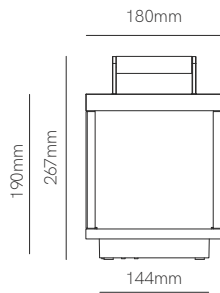

Technical Information

| | |
|-------------------|--|
| Version | Visor |
| Power | 5W |
| Installation | Portable |
| Color Temperature | 3.000K |
| Lumens | 460 lm / 230 lm / 46 lm |
| Material | Aluminium |
| Finishes | White / Corten |
| Code | 3929 <input type="checkbox"/> |
| | 3931 <input checked="" type="checkbox"/> |



*Charger by USB. Charger included.

3 YEARS WARRANTY BATTERY 2 YEARS | 30.000 HOURS | 6,5 HOURS | 5/11/25 HOURS | 3,7V USB | 7.800 mAh | IP 65 | CRI ≥80 | 120° | IK05 | 3 INTENSITIES | +45°C / -20°C | 1/4



Fix

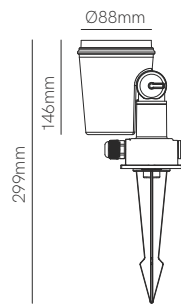

Technical Information

| | |
|--------------|-----------------|
| Version | Fix |
| Installation | Surface / Floor |
| Material | Polypropylene |
| Finishes | Black |
| Lamp Holder | E27 |
| Code | 4820 ■ |



*Spike included. Recommended lamp Par 38 (page 568).

3 YEARS WARRANTY | IP 65 | 50/60 Hz | 1/6



Sair 10W

Sair 20W

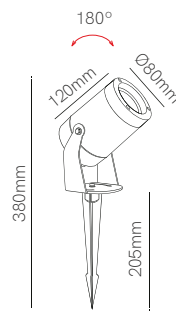
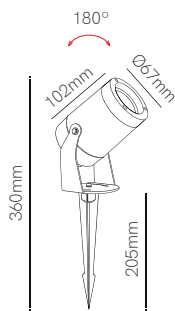

Technical Information

| Version | Sair 10W | Sair 20W |
|-------------------|---|---|
| Power | 10W | 20W |
| Installation | Floor | Floor |
| Color Temperature | 3.000K | 3.000K |
| Lumens | 900 lm | 1.500 lm |
| Material | Aluminium | Aluminium |
| Finishes | White / Black | White / Black |
| Code | 4894 <input type="checkbox"/> 4895 <input checked="" type="checkbox"/> | 4897 <input type="checkbox"/> 4898 <input checked="" type="checkbox"/> |

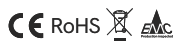

*Spike included.

3 YEARS WARRANTY | 20.000 HOURS | IP 65 | 100/265 VAC | PF >0,9 | CRI ≥95 | GROUNDING | CABLE 24CM | 18° | 50/60 Hz | IK05 | +40°C / -20°C | 1/20



Caddie

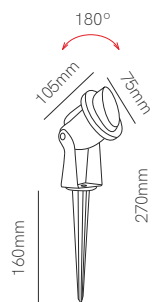

Technical Information

| | |
|-------------------|---|
| Version | Caddie |
| Power | 3W |
| Installation | Floor |
| Color Temperature | 3.000K |
| Lumens | 270 lm |
| Material | Aluminium |
| Finishes | Black / Corten |
| Code | 3581 |
| | 4923 |



*Spike included.

3 YEARS WARRANTY |
 35.000 HOURS |
 IP 65 |
 100/277 VAC |
 PF >0,6 |
 CRI ≥72 |
 |
 CABLE 24CM |
 45° |
 50/60 Hz |
 IK05 |
 +40°C |
 -20°C |
 1/50



Fade

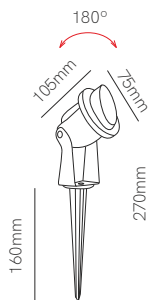

Technical Information

| | |
|-------------------|---|
| Version | Fade |
| Power | 5W |
| Installation | Floor |
| Color Temperature | 3.000K |
| Lumens | 450 lm |
| Material | Aluminium |
| Finishes | Black / Corten |
| Code | 3580 |
| | 4924 |



*Spike included.

3 YEARS WARRANTY |
 35.000 HOURS |
 IP 65 |
 100/277 VAC |
 PF >0,6 |
 CRI ≥80 |
 |
 CABLE 24CM |
 45° |
 50/60 Hz |
 IK05 |
 +40°C |
 -20°C |
 1/50



Zas round



Zas square

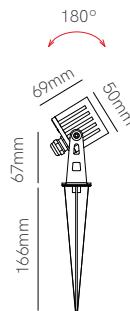
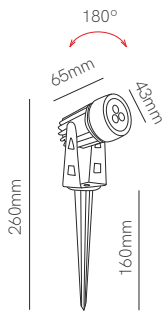

Technical Information

| | | |
|-------------------|----------------|------------------------|
| Version | Zas round | Fade |
| Power | 3W | 7W |
| Installation | Floor | Floor |
| Color Temperature | 3.000K | 3.000K |
| Lumens | 240 lm | 450 lm |
| Material | Aluminium | Aluminium |
| Finishes | Black / Corten | White / Black / Corten |

| | | |
|------|---|---|
| Code | 4134 | 4690 |
| | 4922 | 4692 |
| | | 4693 |

100/277 VAC | 20.000 HOURS | PF >0,6 | 30° | IK05

220/240 VAC | 30.000 HOURS | PF >0,9 | 40° | IK08



*Spike included.

3 YEARS WARRANTY | IP 65 | CRI ≥80 | CABLE 24CM | 50/60 Hz | +40°C / -20°C | 1/50



Sky with spike

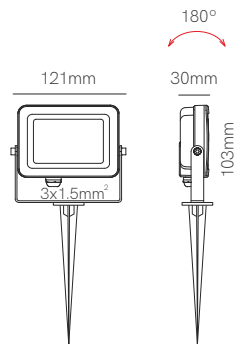

Technical Information

| | |
|-------------------|--|
| Version | Sky with spike |
| Power | 10W |
| Installation | Floor |
| Color Temperature | 3.000K / GREEN |
| Lumens | 1.000 lm / 820 lm |
| Material | Aluminium |
| Finishes | Corten |
| Code | 4340 ■ 3.000K |
| | 4341 ■ GREEN |

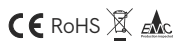

*Spike included.

5 YEARS WARRANTY | 50.000 HOURS | IP 65 | 220/240 VAC | PF >0,9 | CRI ≥80 | 115° | 50/60 Hz | IK08 | +45°C / -20°C | AKZO NOBEL | >1KV | 1/32



Sky switch 10W

Sky switch 20W

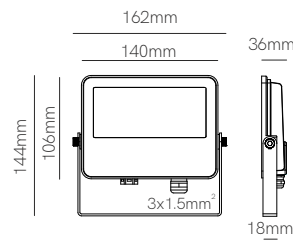
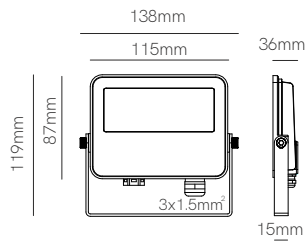

Technical Information

| | | |
|-------------------|--|--|
| Version | Sky switch 10W | Sky switch 20W |
| Power | 10W | 20W |
| Installation | Surface | Surface |
| Color Temperature | Switch 3.000K / 4.000K / 5.000K | Switch 3.000K / 4.000K / 5.000K |
| Lumens | 1.200 lm | 2.400 lm |
| Material | Aluminium | Aluminium |
| Finishes | White / Black / Gray | White / Black / Gray |
| Code | 4679 <input type="checkbox"/> | 4682 <input type="checkbox"/> |
| | 4680 <input checked="" type="checkbox"/> | 4683 <input checked="" type="checkbox"/> |
| | 4681 <input checked="" type="checkbox"/> | 4684 <input checked="" type="checkbox"/> |



Accessories

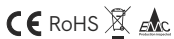
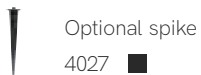

3 YEARS WARRANTY | 25.000 HOURS | IP 65 | 180/260 VAC | PF >0,9 | CRI ≥80 | 115° | 50/60 Hz | IK08 | +45°C / -20°C | AKZO NOBEL | CCT SWITCH | >1KV

Sky switch 30W

Sky switch 40W

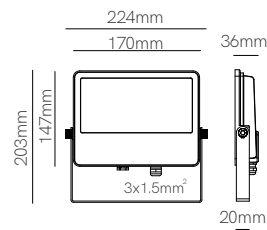
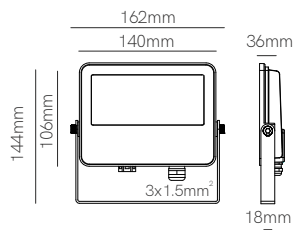

Technical Information

| Version | Sky switch 30W | Sky switch 40W |
|-------------------|---|---|
| Power | 30W | 40W |
| Installation | Surface | Surface |
| Color Temperature | Switch 3.000K / 4.000K / 5.000K | Switch 3.000K / 4.000K / 5.000K |
| Lumens | 3.600 lm | 4.800 lm |
| Material | Aluminium | Aluminium |
| Finishes | White / Black / Gray | White / Black / Gray |
| Code | 4685 <input type="checkbox"/> 4686 <input checked="" type="checkbox"/> 4687 <input checked="" type="checkbox"/> | 4688 <input type="checkbox"/> 4689 <input checked="" type="checkbox"/> 4694 <input checked="" type="checkbox"/> |



Accessories

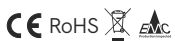
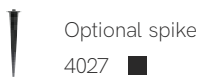

3 YEARS WARRANTY | 25.000 HOURS | IP 65 | 180/260 VAC | PF >0,9 | CRI ≥80 | | 115° | 50/60 Hz | | +45°C / -20°C | AKZO NOBEL | CCT SWITCH | >1KV

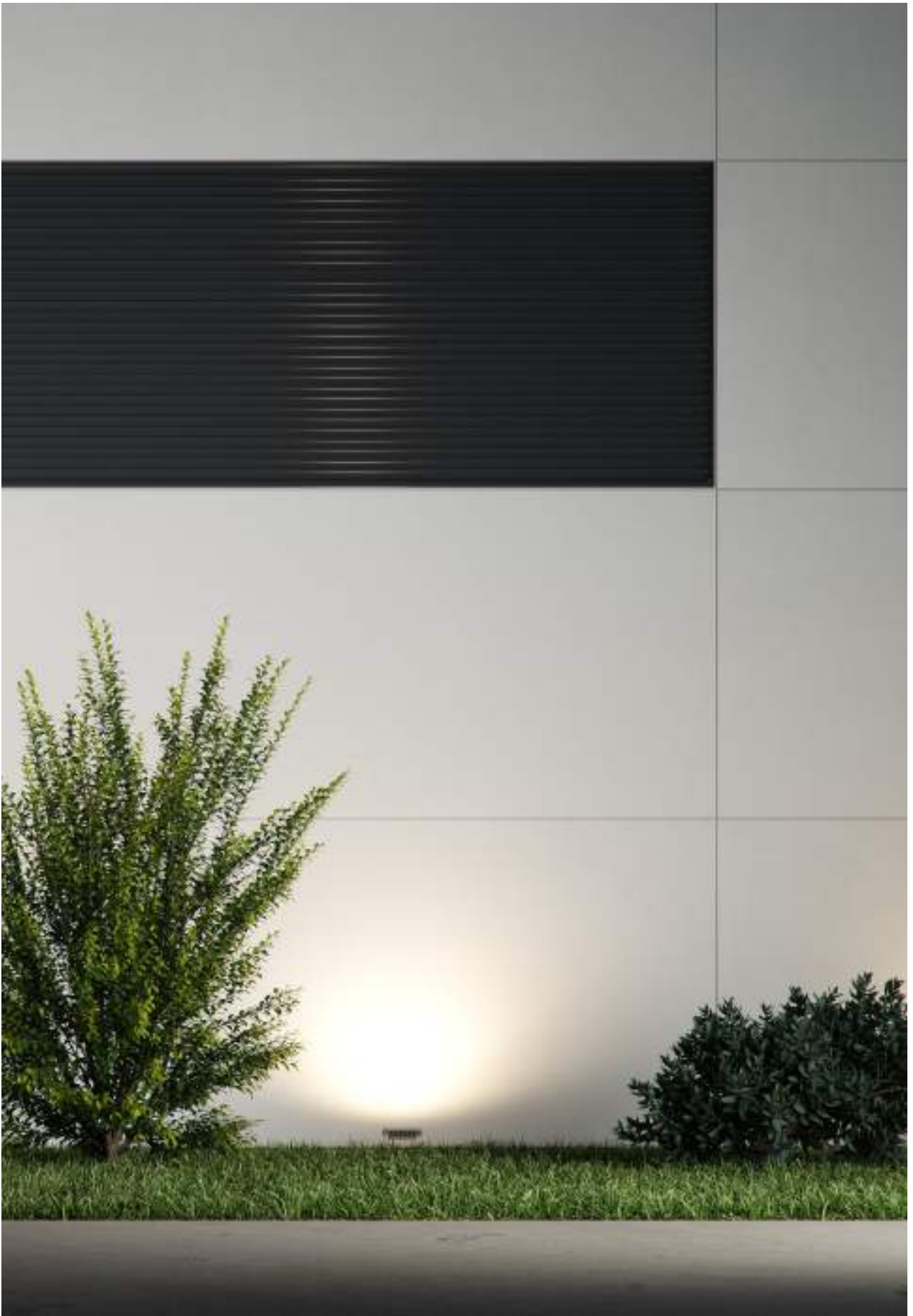

Sky microwave sensor 10W

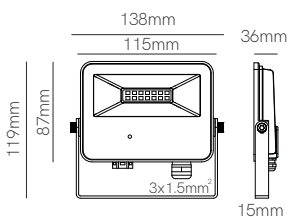

Sky microwave sensor 30W

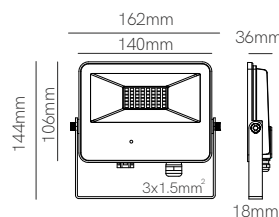

Sky microwave sensor 50W

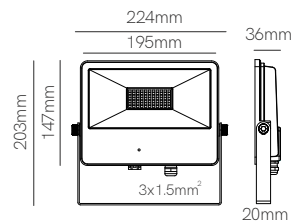

Technical Information

| | | | |
|-------------------|--------------------------|--------------------------|--------------------------|
| Version | Sky microwave sensor 10W | Sky microwave sensor 30W | Sky microwave sensor 50W |
| Power | 10W | 30W | 50W |
| Installation | Surface | Surface | Surface |
| Color Temperature | 4.000K / 5.000K | 4.000K / 5.000K | 4.000K / 5.000K |
| Lumens | 1.150 lm / 1.200 lm | 3.550 lm / 3.600 lm | 5.950 lm / 6.000 lm |
| Material | Aluminium | Aluminium | Aluminium |
| Finishes | White / Black | White / Black | White / Black |

| | | | |
|------|---|---|---|
| Code | 4349 <input type="checkbox"/> 4.000K | 4352 <input type="checkbox"/> 4.000K | 4354 <input type="checkbox"/> 4.000K |
| | 4350 <input type="checkbox"/> 5.000K | 4353 <input type="checkbox"/> 5.000K | 4355 <input type="checkbox"/> 5.000K |
| | 4308 <input checked="" type="checkbox"/> 4.000K | 4309 <input checked="" type="checkbox"/> 4.000K | 4311 <input checked="" type="checkbox"/> 4.000K |
| | 4351 <input checked="" type="checkbox"/> 5.000K | 4310 <input checked="" type="checkbox"/> 5.000K | 4356 <input checked="" type="checkbox"/> 5.000K |



Accessories

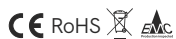
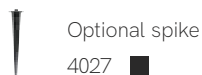

5 YEARS WARRANTY | 50.000 HOURS | IP 65 | 220/240 VAC | PF >0,9 | CRI ≥80 | 115° | 50/60 Hz | IK08 | +45°C / -20°C | AKZO NOBEL MICROWAVE SENSOR | 5 sec ON / 5 min OFF | 1m / 7m | >1KV

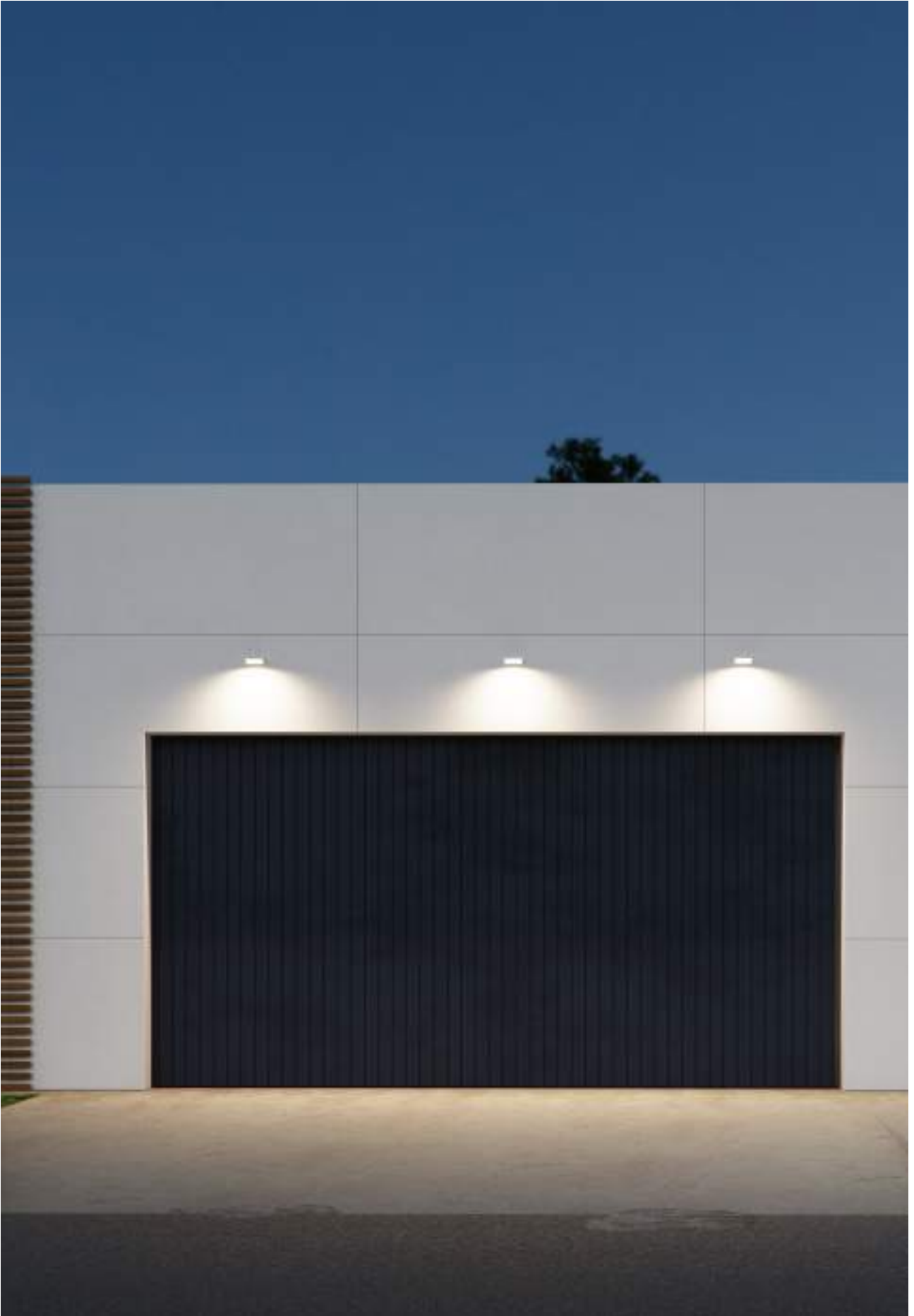





Sky 10W

Sky 20W

Sky 30W

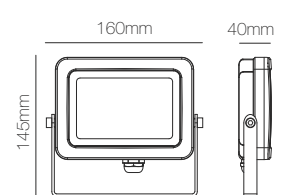
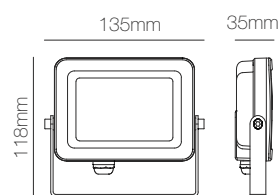
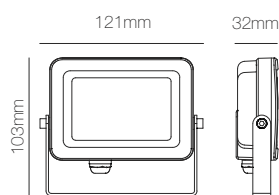

Technical Information

| Version | Sky 10W | Sky 20W | Sky 30W |
|-------------------|---------------|--------------------------------|--------------------------------|
| Power | 10W | 20W | 30W |
| Installation | Surface | Surface | Surface |
| Color Temperature | 5.000K | 2.700K / 4.000K / 5.000K | 2.700K / 4.000K / 5.000K |
| Lumens | 1.150 lm | 2.250 lm / 2.400 lm / 2.450 lm | 3.450 lm / 3.600 lm / 3.650 lm |
| Material | Aluminium | Aluminium | Aluminium |
| Finishes | White / Black | White / Black / Corten | Gray / Corten |

| Code | Sky 10W | Sky 20W | Sky 30W |
|------|---|---|---|
| | 4254 <input type="checkbox"/> 5.000K | 4263 <input type="checkbox"/> 5.000K | 4276 <input type="checkbox"/> 3.000K |
| | 4257 <input checked="" type="checkbox"/> 5.000K | 4266 <input checked="" type="checkbox"/> 5.000K | 4279 <input checked="" type="checkbox"/> 2.700K |
| | | 4401 <input checked="" type="checkbox"/> 2.700K | 4280 <input checked="" type="checkbox"/> 4.000K |
| | | 4402 <input checked="" type="checkbox"/> 4.000K | |



Accessories

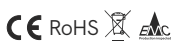
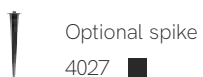

5 YEARS WARRANTY | 50.000 HOURS | IP 65 | 220/240 VAC | PF >0,9 | CRI ≥80 | | 115° | 50/60 Hz | | +45°C / -20°C | AKZO NOBEL | >1KV

Sky 100W

Sky 150W

Sky 200W

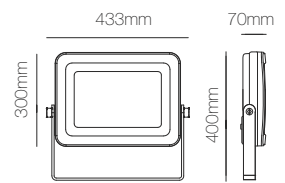
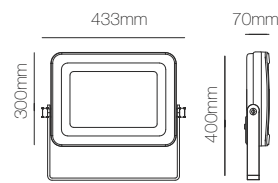
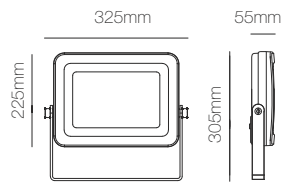

Technical Information

| | | | |
|-------------------|---------------|---------------|---------------|
| Version | Sky 100W | Sky 150W | Sky 200W |
| Power | 100W | 150W | 200W |
| Installation | Surface | Surface | Surface |
| Color Temperature | 2.200K | 2.200K | 2.200K |
| Lumens | 7.000 lm | 11.000 lm | 14.000 lm |
| Material | Aluminium | Aluminium | Aluminium |
| Finishes | White / Black | White / Black | White / Black |
| Code | 3955 ■ | 3956 ■ | 3957 ■ |



5 YEARS WARRANTY | 50.000 HOURS | IP 65 | 220/240 VAC | PF >0,9 | CRI ≥80 | 115° | 50/60 Hz | IK08 | +45°C / -20°C | AKZO NOBEL | >2KV



Club Tennis Olesa, Olesa de Montserrat, Design: Padel 10, (Spain).

Polaris 100W

Polaris 150W

Polaris 200W

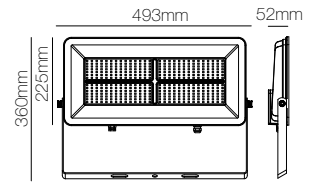
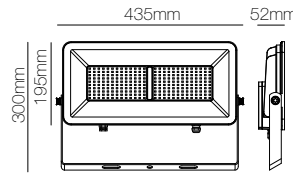
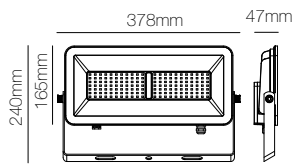
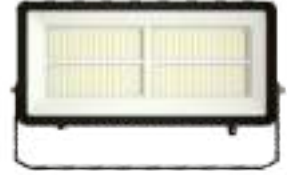

Technical Information

| Version | Polaris 100W | Polaris 150W | Polaris 200W |
|-------------------|-----------------------------------|-----------------------------------|-----------------------------------|
| Power | 100W | 150W | 200W |
| Installation | Surface | Surface | Surface |
| Color Temperature | 3.000K / 4.000K / 5.000K | 3.000K / 4.000K / 5.000K | 3.000K / 4.000K / 5.000K |
| Lumens | 12.700 lm / 13.000 lm / 13.200 lm | 19.200 lm / 19.500 lm / 19.700 lm | 25.700 lm / 26.000 lm / 26.200 lm |
| Material | Aluminium | Aluminium | Aluminium |
| Finishes | Black | Black | Black |

| Code | Polaris 100W | Polaris 150W | Polaris 200W |
|------|---------------|---------------|---------------|
| | 4513 ■ 3.000K | 4516 ■ 3.000K | 4519 ■ 3.000K |
| | 4514 ■ 4.000K | 4517 ■ 4.000K | 4520 ■ 4.000K |
| | 4515 ■ 5.000K | 4518 ■ 5.000K | 4521 ■ 5.000K |

1/4

1/3

1/3

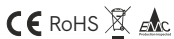

5 YEARS WARRANTY | 50.000 HOURS | IP 65 | 220/240 VAC | PF >0,9 | CRI ≥80 | 115° | 50/60 Hz | IK08 | +45°C / -20°C | AKZO NOBEL | >6KV



Krion 300W

Krion 400W

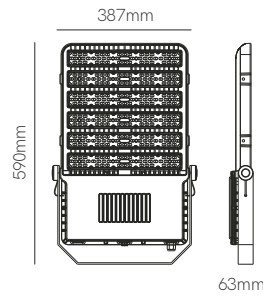
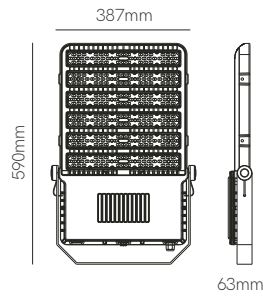

| | | | |
|--------|--------|-------|-------|
| 5m | 10m | 15m | 20m |
| 380 lx | 100 lx | 45 lx | 25 lx |

| | | | |
|--------|--------|-------|-------|
| 5m | 10m | 15m | 20m |
| 470 lx | 120 lx | 55 lx | 30 lx |



Technical Information

| Version | Krion 300W | Krion 400W |
|-------------------|--------------------------------|--------------------------------|
| Power | 300W | 400W |
| Installation | Surface | Surface |
| Color Temperature | 4.000K / 5.000K | 4.000K / 5.000K |
| Lumens | 39.000 lm / 39.300 lm | 52.000 lm / 52.300 lm |
| Material | Aluminium | Aluminium |
| Finishes | Black | Black |
| Code | 4509 ■ 4.000K 4511 ■ 5.000K | 4510 ■ 4.000K 4512 ■ 5.000K |

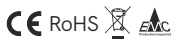

5 YEARS WARRANTY | 50.000 HOURS | IP 65 | 100/277 VAC | PF >0,9 | CRI ≥80 | 80°x140° | 50/60 Hz | IK10 | +45°C / -25°C | AKZO NOBEL | >6KV | 1



New

Wech

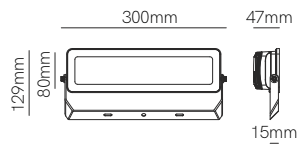
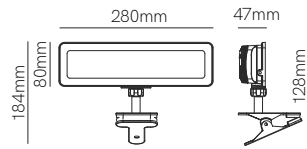

Technical Information

| | |
|-------------------|--|
| Version | Wech |
| Power | 10W |
| Installation | Portable |
| Color Temperature | Switch 3.000K / 4.000K / 5.000K |
| Lumens | 500 lm |
| Material | Aluminium & Polycarbonate |
| Finishes | Black |
| Code | 5004 <input type="checkbox"/> |
| | 5005 <input checked="" type="checkbox"/> |



*Charger by USB. Charger included.

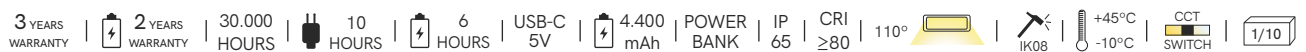





Solar lighting

503. Popa

504. Proa

507. Egna

511. Iris

513. Visor



Popa 60

Popa 100

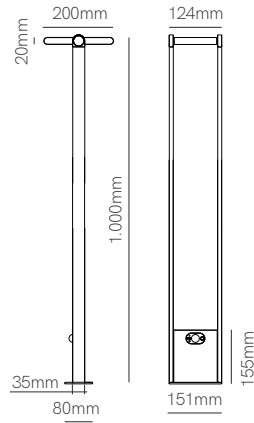
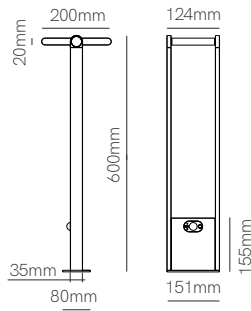

Technical Information

| | | |
|-------------------|--|--|
| Version | Popa 60 | Popa 100 |
| Power | 1,6W | 1,6W |
| Installation | Floor | Floor |
| Color Temperature | 4.000K | 4.000K |
| Lumens | 150 lm | 150 lm |
| Material | Aluminium | Aluminium |
| Finishes | White / Black | White / Black |
| Code | 3882 <input type="checkbox"/> | 3884 <input type="checkbox"/> |
| | 3883 <input checked="" type="checkbox"/> | 3885 <input checked="" type="checkbox"/> |



3 YEARS WARRANTY BATTERY 2 YEARS | 20.000 HOURS | 5-6 HOURS | 15% 100% 10H. 2-3H. | 2.200 mAh | IP 54 | CRI ≥80 | 120° | IK08 | +45°C -25°C | PIR SENSOR | ON OFF | 8 sec 8 min | 1/2

Proa

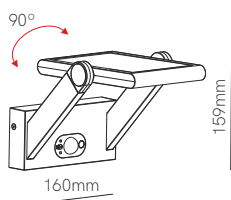

Technical Information

| | |
|-------------------|--|
| Version | Proa |
| Power | 1,6W |
| Installation | Surface |
| Color Temperature | 4.000K |
| Lumens | 150 lm |
| Material | Aluminium |
| Finishes | White / Black |
| Code | 3531 <input type="checkbox"/> |
| | 3532 <input checked="" type="checkbox"/> |

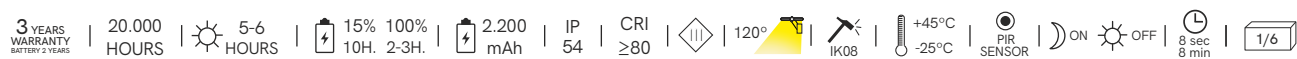
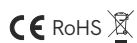





Egna

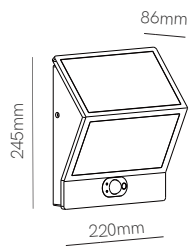

Technical Information

| | |
|-------------------|--|
| Version | Egna |
| Power | 3W |
| Installation | Surface |
| Color Temperature | 4.000K |
| Lumens | 250 lm |
| Material | Aluminium |
| Finishes | White / Black |
| Code | 3587 <input type="checkbox"/> |
| | 3592 <input checked="" type="checkbox"/> |

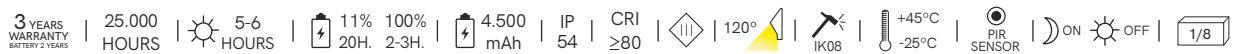







Iris

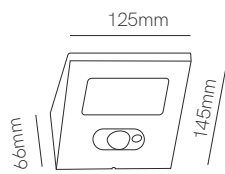

Technical Information

| | |
|-------------------|--|
| Version | Iris |
| Power | 2,5W |
| Installation | Surface |
| Color Temperature | 4.000K |
| Lumens | 174 lm |
| Material | Aluminium |
| Finishes | White / Black |
| Code | 3496 <input type="checkbox"/> |
| | 3497 <input checked="" type="checkbox"/> |



3 YEARS WARRANTY BATTERY 2 YEARS | 20.000 HOURS | 5-6 HOURS | 15% 100% 10H. 2-3H. | 2.200 mAh | IP 54 | CRI ≥80 | 120° | IK08 | +45°C -25°C | PIR SENSOR | ON OFF | 8 sec 8 min | 1/6

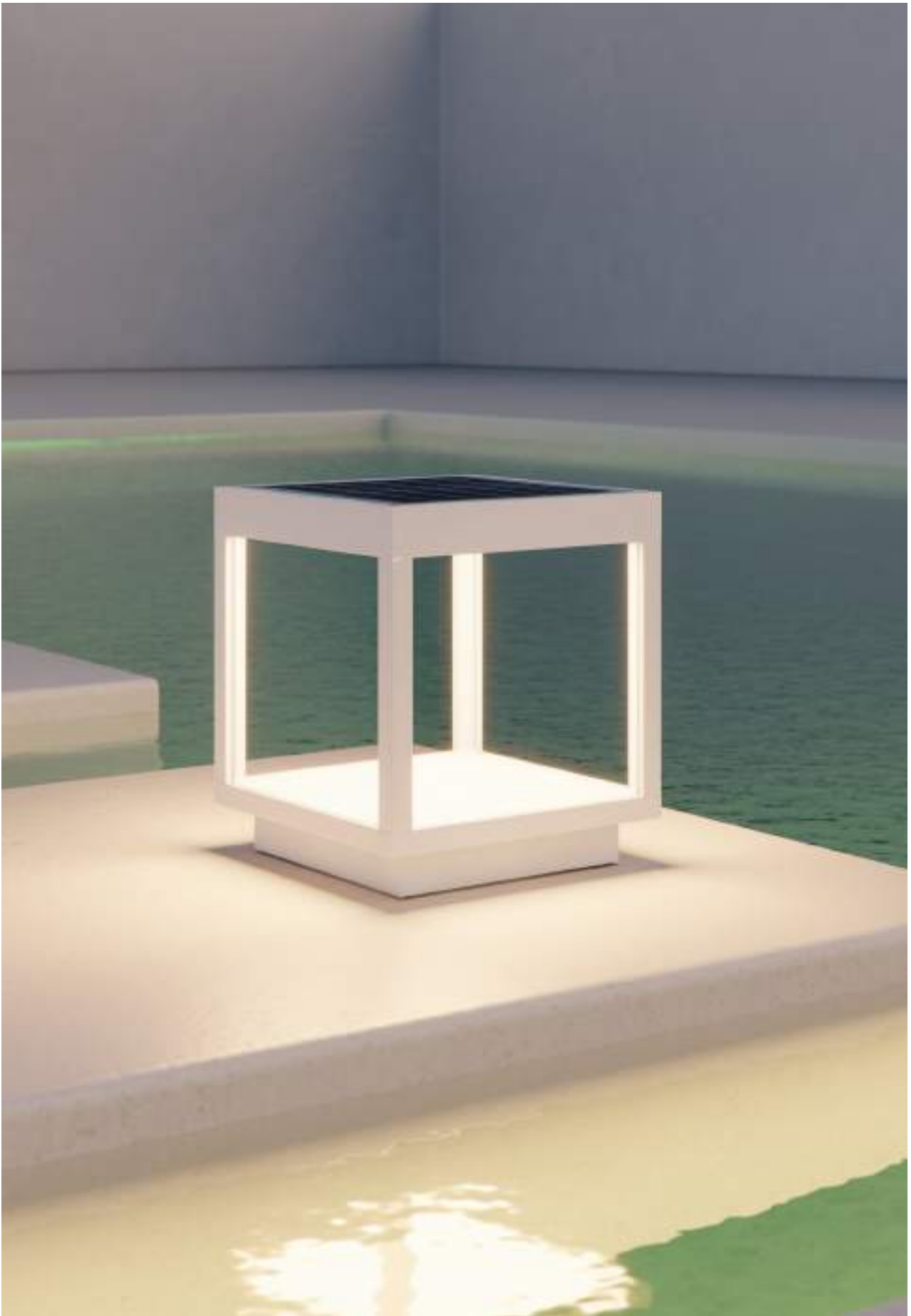

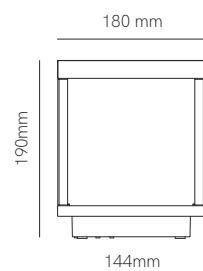
 Visor solar

 Technical Information

| | |
|-------------------|-------------------------------|
| Version | Visor solar |
| Power | 3,5W |
| Installation | Portable |
| Color Temperature | 3.000K |
| Lumens | 460 lm |
| Material | Aluminium |
| Finishes | White / Black / Corten |
| Code | 4209 <input type="checkbox"/> |
| | 4193 <input type="checkbox"/> |
| | 4194 <input type="checkbox"/> |

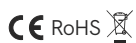





Rings

519. Avant
521. One
523. Zio
525. Rok
527. Luk
529. Bathroom
531. Eclipse
535. Basculante
537. Fijo



New

Avant round



Avant square



Avant surface round

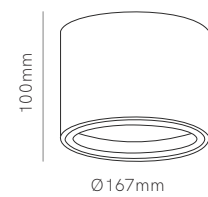
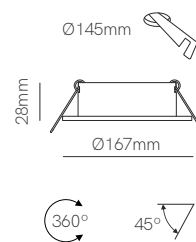
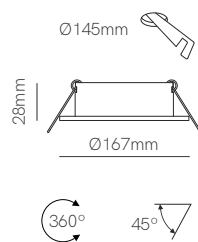

Technical Information

| Version | Avant round | Avant square | Avant surface round |
|--------------|---|---|---|
| Installation | Recessed | Recessed | Surface |
| Material | Aluminium | Aluminium | Aluminium |
| Finishes | White / Black | White / Black | White / Black |
| Bulbholder | 111mm GU10 | 111mm GU10 | 111mm GU10 |
| Code | 4486 <input type="checkbox"/> 4487 <input checked="" type="checkbox"/> | 4484 <input type="checkbox"/> 4485 <input checked="" type="checkbox"/> | 4933 <input type="checkbox"/> 4934 <input checked="" type="checkbox"/> |

1/20

1/20

1/10

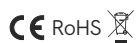

*GU10 Bulbholder included.

 3 YEARS WARRANTY |  | IP 20



One recessed

One surface

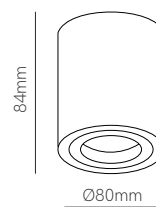
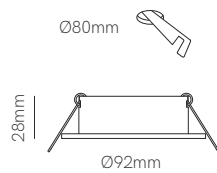

Technical Information

| | | |
|--------------|--|--|
| Version | One recessed | One surface |
| Installation | Recessed | Surface |
| Material | Aluminium | Aluminium |
| Finishes | White / Black / Brushed alumin. | White / Black |
| Bulbholder | 50mm GU10 | 50mm GU10 |
| Code | 4478 <input type="checkbox"/> | 4480 <input type="checkbox"/> |
| | 4479 <input checked="" type="checkbox"/> | 4481 <input checked="" type="checkbox"/> |
| | 258226C <input type="checkbox"/> | |

1/50

1/20

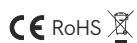

*GU10 Bulbholder included, except 258226C.





Zio recessed



Zio surface

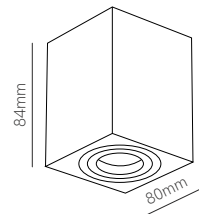
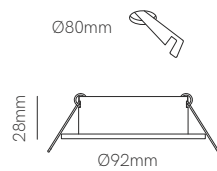

Technical Information

| | | |
|--------------|---|--|
| Version | Zio recessed | Zio surface |
| Installation | Recessed | Surface |
| Material | Aluminium | Aluminium |
| Finishes | White / Black / Brushed alumin. | White / Black |
| Bulbholder | 50mm GU10 | 50mm GU10 |
| Code | 4476 <input type="checkbox"/> | 4482 <input type="checkbox"/> |
| | 4477 <input checked="" type="checkbox"/> | 4483 <input checked="" type="checkbox"/> |
| | 257226C <input checked="" type="checkbox"/> | |

1/50

1/20

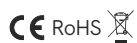

*GU10 Bulbholder included, except 257226C.





Rok

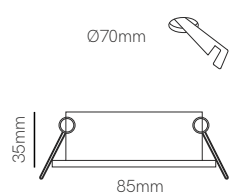

Technical Information

| | |
|--------------|--------------------------------|
| Version | Rok |
| Installation | Recessed |
| Material | Aluminium |
| Finishes | White / Black / Brushed chrome |
| Bulbholder | 50mm G5.3 |

| | |
|------|--|
| Code | 4755 <input type="checkbox"/> |
| | 4756 <input checked="" type="checkbox"/> |
| | 4757 <input type="checkbox"/> |



*G5.3 Bulbholder included.



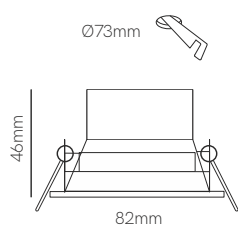

 Luk

 Technical Information

| | |
|--------------|--|
| Version | Luk |
| Installation | Recessed |
| Material | Aluminium |
| Finishes | White / Black |
| Bulbholder | 50mm GU10 |
| Code | 4758 <input type="checkbox"/> |
| | 4759 <input checked="" type="checkbox"/> |

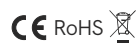

*GU10 Bulbholder included.



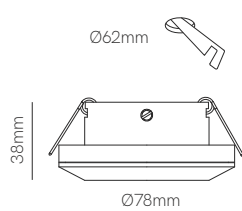

 Bathroom

 Technical Information

| | |
|--------------|---------------------------------|
| Version | Bathroom |
| Installation | Recessed |
| Material | Aluminium |
| Finishes | White / Brushed aluminium |
| Bulbholder | 50mm G5.3 |
| Code | 223232 <input type="checkbox"/> |
| | 223233 <input type="checkbox"/> |



*G5.3 Bulbholder included.





Eclipse

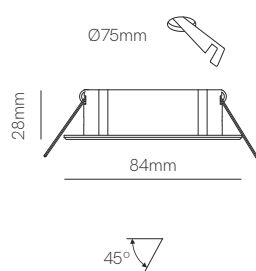

Technical Information

| | |
|--------------|-------------------------------|
| Version | Eclipse |
| Installation | Recessed |
| Material | Aluminium |
| Finishes | White / Gray / Brushed chrome |
| Bulbholder | 50mm G5.3 |

| | |
|------|---------------------------------|
| Code | 222232 <input type="checkbox"/> |
| | 222230 <input type="checkbox"/> |
| | 222238 <input type="checkbox"/> |

Accessories



Bulbholder GU10

301182



*G5.3 Bulbholder included.

3 YEARS WARRANTY | IP 20 | 1/50







Basculante

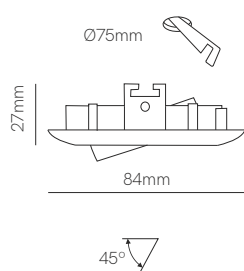

Technical Information

| | |
|--------------|-------------------------------|
| Version | Basculante |
| Installation | Recessed |
| Material | Aluminium |
| Finishes | White / Gray / Brushed chrome |
| Bulbholder | 50mm G5.3 |

| | |
|------|---------------------------------|
| Code | 205280 <input type="checkbox"/> |
| | 205284 <input type="checkbox"/> |
| | 205285 <input type="checkbox"/> |

Accessories



Bulbholder GU10

301182



*G5.3 Bulbholder included.

3 YEARS WARRANTY | IP 20 | 1/50

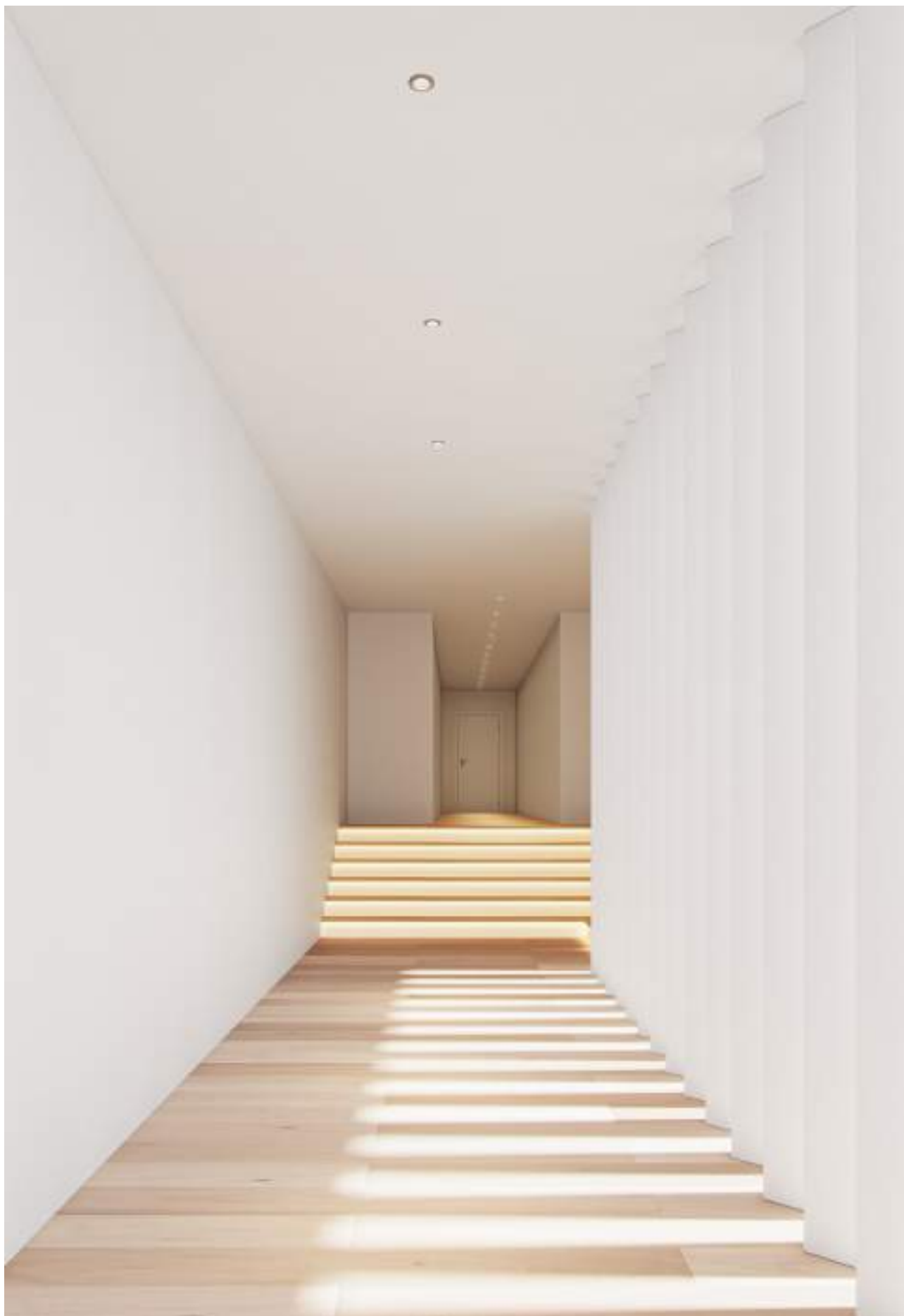

Fijo

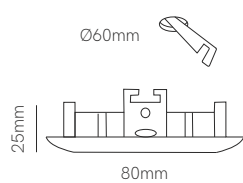

Technical Information

| | |
|--------------|-------------------------------|
| Version | Fijo |
| Installation | Recessed |
| Material | Aluminium |
| Finishes | White / Gray / Brushed chrome |
| Bulbholder | 50mm G5.3 |

| | |
|------|---------------------------------|
| Code | 206280 <input type="checkbox"/> |
| | 206284 <input type="checkbox"/> |
| | 206285 <input type="checkbox"/> |

Accessories



Bulbholder GU10

301182



*G5.3 Bulbholder included.

3 YEARS WARRANTY | IP 20 | 1/50

Retrofit

- 540. Nitro and Dole
- 541. Lynk
- 542. Max
- 543. Power
- 544. System
- 545. Hook
- 546. Uniform-line
- 547. Narrow
- 548. Tutto
- 549. Adn
- 550. Uniform-line G4
- 551. Uniform-line G9
- 552. Shop, Prisma
- 553. Pl T40
- 554. Cala
- 555. HQI Tubular
- 556. Lineal
- 558. Esférica
- 559. Standard
- 562. Globo
- 564. Flama
- 565. R-63 S-line
- 566. Reflectors
- 568. Par
- 569. Sil
- 570. Aria
- 571. Cup
- 572. Moon
- 573. Noa
- 575. Smile
- 576. Obo

Nitro

Dole

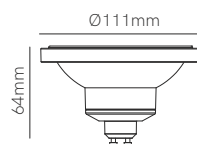
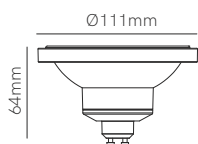

Technical Information

| | | |
|-------------------|------------|---|
| Version | Nitro GU10 | Dole GU10 |
| Power | 15W | 15W |
| Color Temperature | 2.700K | 2.700K / 3.000K / 4.000K |
| Lumens | 1.000 lm | 1.050 lm / 1.100 lm / 1.120 lm |
| Code | 3470 | 3467 2.700K 3468 3.000K 3469 4.000K |



3 YEARS WARRANTY | 25.000 HOURS | IP 40 | 220/240 VAC | PF >0,9 | CRI ≥80 | 45° | 50/60 Hz | +40°C / -20°C | 10/30

Lynk G53

Lynk GU10

Lynk GU10 dimmable

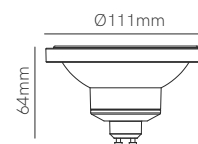
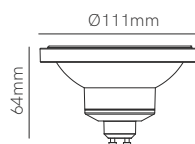
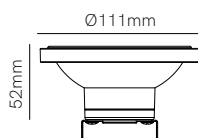

Technical Information

| Version | Lynk G53 | Lynk GU10 | Lynk GU10 dimmable |
|-------------------|---|---|---|
| Power | 13W | 13W | 13W |
| Color Temperature | 2.700K / 3.000K / 4.000K | 2.700K / 3.000K / 4.000K | 2.700K / 3.000K / 4.000K |
| Lumens | 880 lm / 900 lm / 950 lm | 880 lm / 900 lm / 950 lm | 880 lm / 900 lm / 950 lm |
| Code | 3452 2.700K 3453 3.000K 3454 4.000K | 3455 2.700K 3456 3.000K 3457 4.000K | 3464 2.700K 3465 3.000K 3466 4.000K |

12V
AC/DC

220/240
VAC

220/240
VAC

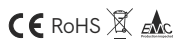

3 YEARS WARRANTY | 25.000 HOURS | IP 40 | PF >0,9 | CRI ≥80 | 45° | 50/60 Hz | +40°C / -20°C | 10/30

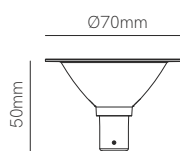
 Max

 Technical Information

| | |
|-------------------|-----------|
| Version | Max BA15d |
| Power | 7W |
| Color Temperature | 2.700K |
| Lumens | 500 lm |
| Code | 3569 |

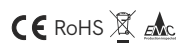

 3 YEARS WARRANTY | 25.000 HOURS | IP 40 | 12V AC/DC | PF >0,5 | CRI ≥80 | 24° | 50/60 Hz | +40°C -20°C | 6/30

Power MR16

Power GU10

Power GU10 dimmable

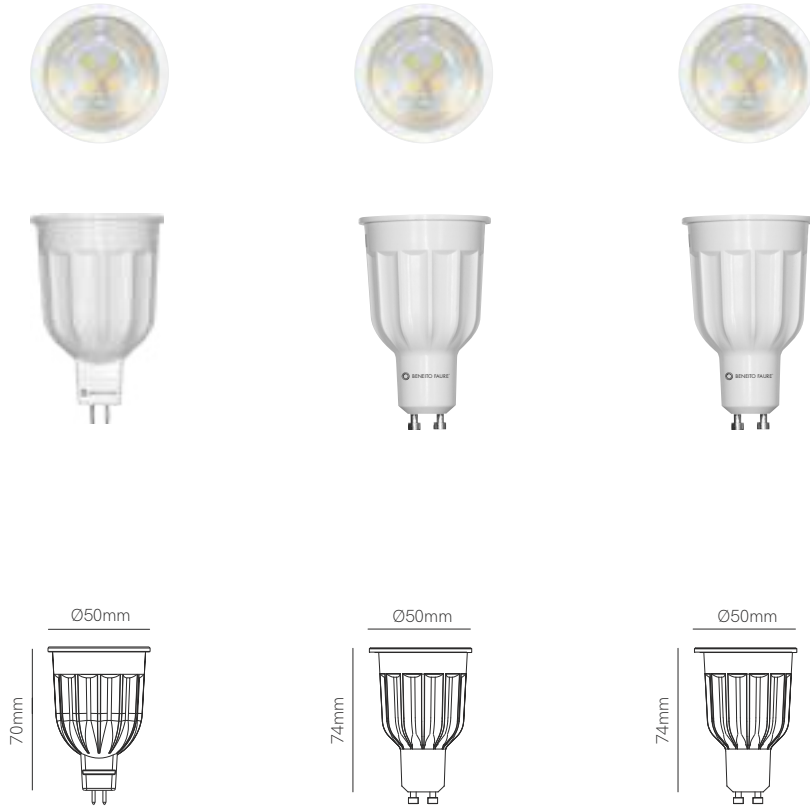

Technical Information

| Version | Power MR16 | Power GU10 | Power GU10 dimmable |
|-------------------|---|---|---|
| Power | 12W | 10W / 12W | 12W |
| Color Temperature | 2.700K / 3.000K / 4.000K | 2.700K / 3.000K / 4.000K | 2.700K / 3.000K / 4.000K |
| Lumens | 900 lm / 950 lm / 1.000 lm | 950 lm / 1.000 lm / 1.050 lm | 950 lm / 1.000 lm / 1.050 lm |
| Code | 3441 2.700K 3442 3.000K 3443 4.000K | 3438 12W 2.700K 4295 10W 3.000K 4296 10W 4.000K | 3489 2.700K 3490 3.000K 3491 4.000K |
| | 12V AC/DC | 220/240 VAC | 220/240 VAC TRIAC DIMM |

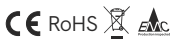

3 YEARS WARRANTY | 25.000 HOURS | IP 40 | PF >0,9 | CRI ≥80 | 60° | 50/60 Hz | +40°C / -20°C | 10/50

System MR16

System GU10

System GU10 dimmable

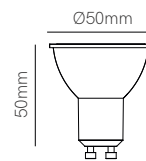
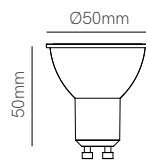
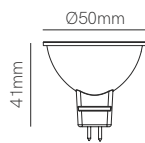

Technical Information

| Version | System MR16 | System GU10 | System GU10 dimmable |
|-------------------|---|---|---|
| Power | 8W | 8W | 8W |
| Color Temperature | 2.700K / 3.000K / 4.000K | 2.700K / 3.000K / 4.000K | 2.700K / 3.000K / 4.000K |
| Lumens | 725 lm / 780 lm / 825 lm | 725 lm / 780 lm / 825 lm | 660 lm / 700 lm / 750 lm |
| Code | 3435-N 2.700K 3436-N 3.000K 3437-N 4.000K | 3432-N 2.700K 3433-N 3.000K 3434-N 4.000K | 3492-N 2.700K 3493-N 3.000K 3494-N 4.000K |
| | 12V AC/DC | 220/240 VAC | 220/240 VAC TRIAC DIMM |

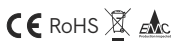

3 YEARS WARRANTY | 25.000 HOURS | IP 40 | PF >0,9 | CRI ≥80 | 60° | 50/60 Hz | +40°C / -20°C | 10/50



Technical Information

| | | |
|-------------------|---|---|
| Version | Hook GU10 | Hook GU10 dimmable |
| Power | 6W | 6W |
| Color Temperature | 2.700K / 3.000K / 4.000K | 2.700K / 3.000K / 4.000K |
| Lumens | 570 lm / 594 lm / 616 lm | 570 lm / 594 lm / 616 lm |
| Code | 4023 2.700K 4024 3.000K 4025 4.000K | 3654-N 2.700K 3655-N 3.000K 3656-N 4.000K |

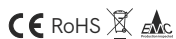

3 YEARS WARRANTY | 25.000 HOURS | IP 40 | 220/240 VAC | PF >0,9 | CRI ≥80 | 60° | 50/60 Hz | +40°C / -20°C | 10/50

Uniform-line MR16

Uniform-line GU10

Uniform-line GU10 dimmable

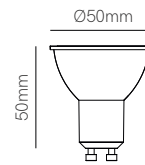
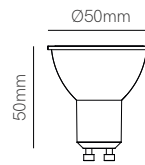
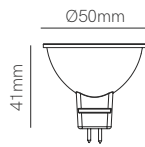

Technical Information

| | | | |
|-------------------|-----------------------------|-----------------------------|----------------------------|
| Version | Uniform-line MR16 | Uniform-line GU10 | Uniform-line GU10 dimmable |
| Power | 6W | 6W | 6W |
| Color Temperature | 2.700K/3.000K/4.000K/5.000K | 2.700K/3.000K/4.000K/5.000K | 2.700K / 3.000K / 4.000K |
| Lumens | 480 lm/510 lm/545 lm/560 lm | 480 lm/510 lm/545 lm/560 lm | 490 lm / 500 lm / 530 lm |

| | | | | | | |
|------|---------|--------|---------|--------|------|--------|
| Code | 4019-V2 | 2.700K | 4015-V2 | 2.700K | 4227 | 2.700K |
| | 4020-V2 | 3.000K | 4016-V2 | 3.000K | 4228 | 3.000K |
| | 4021-V2 | 4.000K | 4017-V2 | 4.000K | 4229 | 4.000K |
| | 4022-V2 | 5.000K | 4018-V2 | 5.000K | | |

12V
AC/DC

220/240
VAC

220/240
VAC

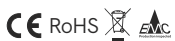

5 YEARS WARRANTY | 50.000 HOURS | IP 40 | PF >0,9 | CRI ≥80 | 120° | 50/60 Hz | +40°C / -20°C | 10/50

Narrow MR16

Narrow GU10 dimmable

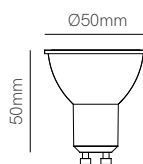
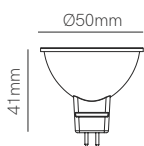

Technical Information

| | | |
|-------------------|-------------|----------------------------|
| Version | Narrow MR16 | Narrow GU10 dimmable |
| Power | 7W | 7W |
| Color Temperature | 3.000K | 2.700K / 3.000K |
| Lumens | 420 lm | 400 lm / 420 lm |
| Code | 3473 | 4672 2.700K 4671 3.000K |

12V
AC/DC

220/240
VAC

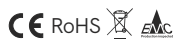

3 YEARS WARRANTY | 25.000 HOURS | IP 40 | PF >0,8 | CRI ≥80 | 15° | 50/60 Hz | +40°C / -20°C | 10/50

Tutto MR11

Tutto GU10

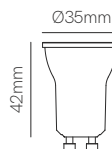
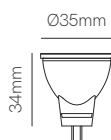

Technical Information

| Version | Tutto MR11 | Tutto GU10 |
|-------------------|---|---|
| Power | 4W | 4W |
| Color Temperature | 2.700K / 3.000K / 4.000K | 2.700K / 3.000K / 4.000K |
| Lumens | 240 lm / 250 lm / 260 lm | 285 lm / 300 lm / 315 lm |
| Code | 3447 2.700K 3448 3.000K 3449 4.000K | 3444 2.700K 3445 3.000K 3446 4.000K |
| | 12V AC/DC | 220/240 VAC |

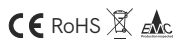

3 YEARS WARRANTY | 25.000 HOURS | IP 40 | PF >0,9 | CRI ≥80 | 60° | 50/60 Hz | +40°C / -20°C | 10/50

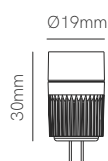

Adn

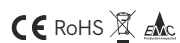

Technical Information

| | |
|-------------------|---------|
| Version | Adn G4 |
| Power | 2,5W |
| Color Temperature | 3.000K |
| Lumens | 198 lm |
| Code | 130L006 |



3 YEARS WARRANTY | 25.000 HOURS | IP 40 | 12V AC/DC | PF >0,6 | CRI ≥80 | 360°  | 50/60 Hz |  +40°C -20°C |  10/50

Uniform-line G4

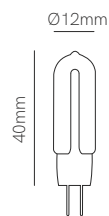

Uniform-line long G4

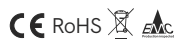

Technical Information

| Version | Uniform-line G4 | Uniform-line long G4 |
|-------------------|---------------------------------------|--------------------------------------|
| Power | 1,3W | 1,6W |
| Color Temperature | 3.000K / 5.000K | 3.000K / 5.000K |
| Lumens | 150 lm / 158 lm | 203 lm / 223 lm |
| Code | 130L006-2 3.000K 130L006-2F 5.000K | 130L195-C 3.000K 130L195-D 5.000K |



3 YEARS WARRANTY | 25.000 HOURS | IP 40 | 12V AC/DC | PF >0,5 | CRI ≥80 | 360°  | 50/60 Hz |  +40°C -20°C |  10/50

Uniform-line G9

Uniform-line long G9

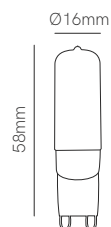
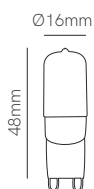

Technical Information

| Version | Uniform-line G9 | Uniform-line long G9 |
|-------------------|---------------------------------------|--------------------------------------|
| Power | 2,5W | 2,8W |
| Color Temperature | 3.000K / 5.000K | 3.000K / 5.000K |
| Lumens | 242 lm / 250 lm | 308 lm / 314 lm |
| Code | 130L184-5 3.000K 130L184-5F 5.000K | 130L195-A 3.000K 130L195-B 5.000K |

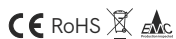

3 YEARS WARRANTY | 25.000 HOURS | IP 40 | 220/240 VAC | PF >0,8 | CRI ≥80 | 360° | 50/60 Hz | +40°C / -20°C | 10/50

Shop

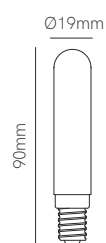
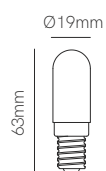

Prisma

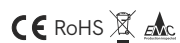

Technical Information

| | | |
|-------------------|----------|------------|
| Version | Shop E14 | Prisma E14 |
| Power | 2W | 4W |
| Color Temperature | 3.000K | 3.000K |
| Lumens | 180 lm | 340 lm |
| Code | 3450 | 3474-M |







3 YEARS WARRANTY | 25.000 HOURS | IP 44 | 220/240 VAC | PF >0,3 | CRI ≥80 | 360°  | 50/60 Hz |  +40°C / -20°C | 

 PL T40

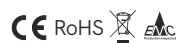
 Technical Information

| | | |
|-------------------|-----------------|--------|
| Version | PL T40 E27 | |
| Power | 10W | |
| Color Temperature | 3.000K / 4.000K | |
| Lumens | 825 lm / 880 lm | |
| Code | 582L016T40E-C3 | 3.000K |
| | 582L016T40E-F | 4.000K |



 3 YEARS WARRANTY | 25.000 HOURS | IP 40 | 220/240 VAC | PF >0,8 | CRI ≥80 | 360°  | 50/60 Hz |  +40°C / -20°C | 

Cala 9W

Cala 10W

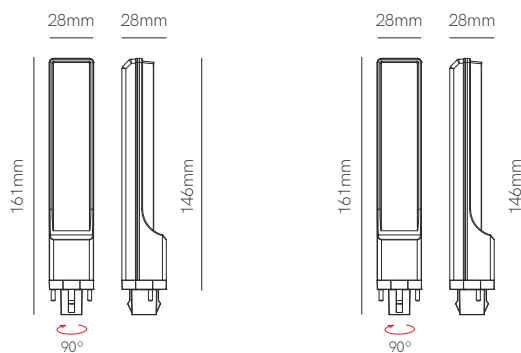

Technical Information

| | | |
|-------------------|--|--|
| Version | Cala 9W G24 | Cala 10W G24 |
| Power | 9W | 10W |
| Color Temperature | 3.000K / 4.000K | 3.000K / 4.000K |
| Lumens | 880 lm / 935 lm | 1.100 lm / 1.155 lm |
| Code | 582L015-C3 3.000K 582L015-F4 4.000K | 582L015-C3B 3.000K 582L015-F4B 4.000K |

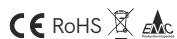

3 YEARS WARRANTY | 25.000 HOURS | IP 40 | 220/240 VAC | PF >0,8 | CRI ≥80 | 135° | 50/60 Hz | +40°C / -20°C | 10/50

HQI tubular RX7S

HQI tubular G12

HQI tubular E27

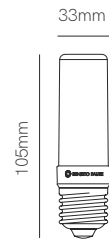
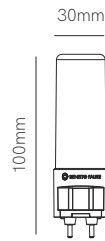
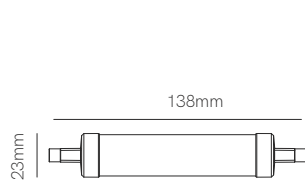

Technical Information

| | | | |
|-------------------|--------------------------------------|--|----------------------------|
| Version | HQI tubular RX7S | HQI tubular G12 | HQI tubular E27 |
| Power | 13W | 10W | 10W |
| Color Temperature | 3.000K / 4.000K | 3.000K / 4.000K | 3.000K / 4.000K |
| Lumens | 1.320 lm / 1.375 lm | 1.000 lm / 1.030 lm | 1.000 lm / 1.030 lm |
| Code | 592063-TC 3.000K 592063-TF 4.000K | 592063-G12/3 3.000K 592063-G12/4 4.000K | 3570 3.000K 3571 4.000K |

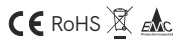

3 YEARS WARRANTY | 25.000 HOURS | IP 40 | 220/240 VAC | PF >0,8 | CRI ≥80 | 360° | 50/60 Hz | +40°C / -20°C

Lineal tubular 5W

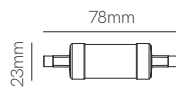

Lineal tubular 9W

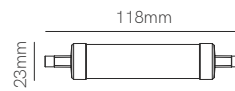
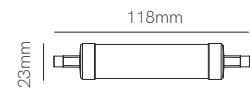
Lineal tubular 9W
dimmable

Technical Information

| | | | |
|-------------------|--|--|--|
| Version | Lineal tubular 5W R7S | Lineal tubular 9W R7S | Lineal tubular 9W R7S dimm. |
| Power | 5W | 9W | 9W |
| Color Temperature | 3.000K / 4.000K | 3.000K / 4.000K | 3.000K / 4.000K |
| Lumens | 561 lm / 574 lm | 935 lm / 1.000 lm | 935 lm / 1.000 lm |
| Code | 140026-C3T 3.000K 140026-F4T 4.000K | 141123-TC3 3.000K 141123-TF4 4.000K | 141123-TC3D 3.000K 141123-TF4D 4.000K |

3 YEARS
WARRANTY

3 YEARS
WARRANTY

4 YEARS
WARRANTY

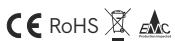

25.000 HOURS | IP 40 | 220/240 VAC | PF >0,8 | CRI ≥80 | 360°  | 50/60 Hz |  +40°C / -20°C |  6/30

Lineal tubular 11W dimmable

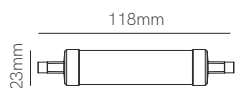

Lineal 13W



Lineal 9W

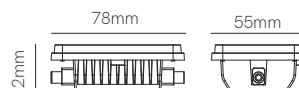

Technical Information

| | | | |
|-------------------|------------------------------|-----------------------------|-----------------|
| Version | Lineal tubular 11W R7S dimm. | Lineal 13W R7S | Lineal 9W R7S |
| Power | 11W | 13W | 9W |
| Color Temperature | 3.000K / 4.000K | 3.000K / 4.000K / 5.000K | 3.000K / 4.000K |
| Lumens | 1.210 lm / 1.280 lm | 1.700 lm / 1.780 lm / 1.800 | 858 lm / 880 lm |

| | | | | | | | | |
|------|------|--------|------|--------|----------|--------|-----------|--------|
| Code | 3477 | 3.000K | 3904 | 3.000K | 140L026L | 3.000K | | |
| | 3478 | 4.000K | | 3905 | | 4.000K | 140L0261L | 4.000K |
| | | | | 3906 | | 5.000K | | |

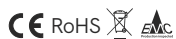

3 YEARS WARRANTY | 25.000 HOURS | IP 40 | 220/240 VAC | PF >0,9 | CRI ≥80 | 50/60 Hz | +40°C / -20°C | 6/30

Esférica 5W

Esférica 5,5W dimmable

Esférica 7W

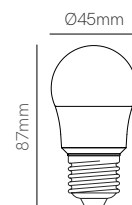
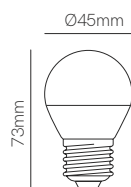
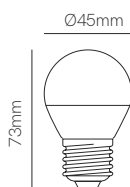

Technical Information

| Version | Esférica 5W E14 / E27 | Esférica 5,5W E14 / E27 dimm. | Esférica 7W E14 / E27 |
|-------------------|---|---|--|
| Power | 5W | 5,5W | 7W |
| Color Temperature | 2.700K/3.000K/4.000K/5.000K | 2.700K / 3.000K / 4.000K | 2.700K/3.000K/4.000K/5.000K |
| Lumens | 440 lm/462 lm/484 lm/495 lm | 396 lm / 418 lm / 440 lm | 700 lm/750 lm/800 lm/820 lm |
| Code | 592563-4C2(N) 2.700K E14 5925631-4C2(N) 2.700K E27 592563(N)-4C(N2) 3.000K E14 5925631(N)-4C(N2) 3.000K E27 592563(N)-4F(N2) 4.000K E14 5925631(N)-4F(N2) 4.000K E27 3538(N) 5.000K E14 3537(N) 5.000K E27 | 592563R-C2 2.700K E14 592563R1-C2 2.700K E27 592563R-C3 3.000K E14 592563R1-C3 3.000K E27 592563R-F4 4.000K E14 592563R1-F4 4.000K E27 | 4243 2.700K E14 4244 2.700K E27 4245 3.000K E14 4246 3.000K E27 4247 4.000K E14 4248 4.000K E27 4249 5.000K E14 4250 5.000K E27 |

5 YEARS WARRANTY | 50.000 HOURS | IP 40

3 YEARS WARRANTY | 25.000 HOURS | IP 40 | TRIAC DIMM

3 YEARS WARRANTY | 25.000 HOURS | IP 20

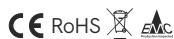

220/240 VAC | PF >0,9 | CRI ≥80 | 360° | 50/60 Hz | +40°C / -20°C | 10/50

Standard 6W

Standard 9W

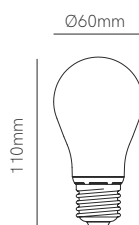
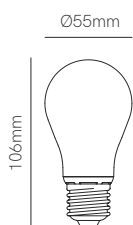

Technical Information

| | | |
|-------------------|---|--|
| Version | Standard 6W E27 | Standard 9W E27 |
| Power | 6W | 9W |
| Color Temperature | 2.700K / 3.000K / 4.000K | 2.700K/3.000K/4.000K/5.000K |
| Lumens | 534 lm / 550 lm / 660 lm | 880 lm/891 lm/935 lm/945 lm |
| Code | 592125S-6(N) 2.700K 592125S-6C(N) 3.000K 592125S-6F(N) 4.000K | 592125SC-2(N) 2.700K 592125SC-3(N) 3.000K 592125SC-4(N) 4.000K 3539(N) 5.000K |

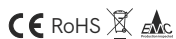

3 YEARS WARRANTY | 25.000 HOURS | IP 40 | 220/240 VAC | PF >0,9 | CRI ≥80 | 360° | 50/60 Hz | +40°C / -20°C |

Standard 12W

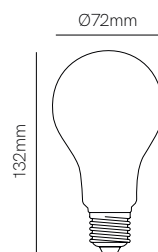
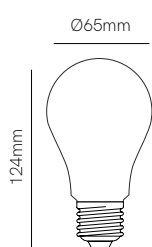

Standard 15W

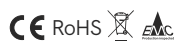

Technical Information

| | | |
|-------------------|--|--|
| Version | Standard 12W E27 | Standard 15W E27 |
| Power | 12W | 15W |
| Color Temperature | 2.700K / 3.000K / 4.000K | 2.700K / 3.000K / 4.000K |
| Lumens | 1.100 lm / 1.122 lm / 1.144 lm | 1.550 lm / 1.600 lm / 1.650 lm |
| Code | 3479(N) 2.700K 3480(N) 3.000K 3481(N) 4.000K | 3482(N) 2.700K 3483(N) 3.000K 3484(N) 4.000K |



3 YEARS WARRANTY | 25.000 HOURS | IP 40 | 220/240 VAC | PF >0,9 | CRI ≥80 | 360°  | 50/60 Hz |  +40°C / -20°C |  10/50

Standard 10W dimmable

Standard 12W dimmable

Standard 17W dimmable

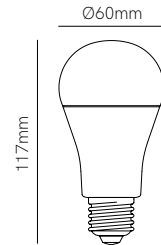
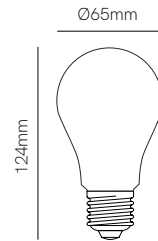
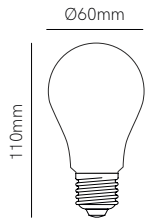

Technical Information

| | | | |
|-------------------|---|--|--|
| Version | Standard 10W E27 dimmable | Standard 12W E27 dimmable | Standard 17W E27 dimmable |
| Power | 10W | 12W | 17W |
| Color Temperature | 2.700K / 3.000K / 4.000K | 2.700K / 3.000K / 4.000K | 2.700K/3.000K/4.000K/5.000K |
| Lumens | 880 lm / 891 lm / 935 lm | 1.100 lm / 1.122 lm / 1.144 lm | 1.550 lm / 1.600 lm / 1.650 lm / 1.700 lm |
| Code | 592125R-C 2.700K 592125R-C3 3.000K 592125R-F 4.000K | 592125R2-C 2.700K 592125R2-C3 3.000K 592125R2-F 4.000K | 3527 2.700K 3528 3.000K 3529 4.000K 3530 5.000K |

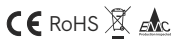

3 YEARS WARRANTY | 25.000 HOURS | IP 40 | 220/240 VAC | PF >0,9 | CRI ≥80 | 360° | 50/60 Hz | TRIAC DIMM | +40°C / -20°C | 10/50

Micro globo 6W

Globo 10W

Globo dimmable 10W

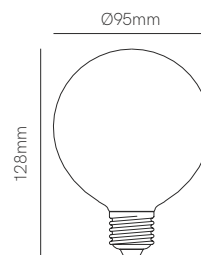
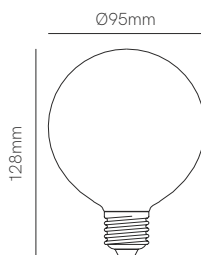
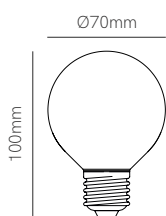

Technical Information

| | | | |
|-------------------|--------------------|--------------------------------|------------------------|
| Version | Micro globo 6W E27 | Globo 10W E27 | Globo dimmable 10W E27 |
| Power | 6W | 10W | 10W |
| Color Temperature | 2.700K / 3.000K | 2.700K / 3.000K / 4.000K | 3.000K |
| Lumens | 480 lm / 500 lm | 1.100 lm / 1.130 lm / 1.180 lm | 800 lm |

| | | | |
|------|-------------|-------------|--------------------|
| Code | 3880 2.700K | 3524 2.700K | 505119DIM-C 3.000K |
| | 3881 3.000K | 3525 3.000K | |
| | | 3526 4.000K | |

5 YEARS WARRANTY | 50.000 HOURS

3 YEARS WARRANTY | 25.000 HOURS

3 YEARS WARRANTY | 25.000 HOURS | TRIAC DIMM

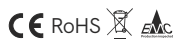

IP 40 | 220/240 VAC | PF >0,8 | CRI ≥80 | 360° | 50/60 Hz | +40°C / -20°C | 10/40

Globo 15W

Globo 16W

Globo 22W

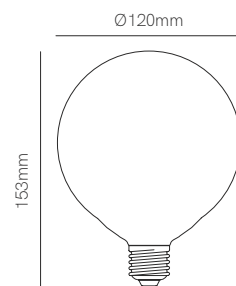
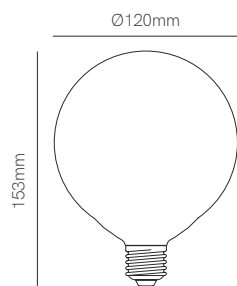
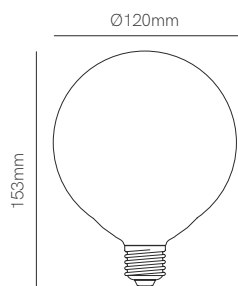

Technical Information

| Version | Globo 15W E27 | Globo 16W E27 | Globo 22W E27 |
|-------------------|----------------------------|---|---|
| Power | 15W | 16W | 22W |
| Color Temperature | 2.700K / 4.000K | 2.700K / 3.000K / 4.000K | 2.700K / 3.000K / 4.000K |
| Lumens | 1.400 lm / 1.500 lm | 1.600 lm / 1.700 lm / 1.750 lm | 2.400 lm / 2.500 lm / 2.600 lm |
| Code | 4677 2.700K 4678 4.000K | 3521 2.700K 3522 3.000K 3523 4.000K | 3518 2.700K 3519 3.000K 3520 4.000K |

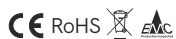

3 YEARS WARRANTY | 25.000 HOURS | IP 40 | 220/240 VAC | PF >0,9 | CRI ≥80 | 360° | 50/60 Hz | +40°C / -20°C | 10/40

Flama

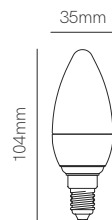

Flama dimmable

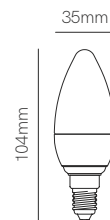



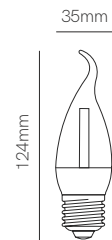

Flama deco transparent

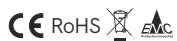

Technical Information

| | | | |
|-------------------|---|--------------------|----------------------------|
| Version | Flama E14 / E27 | Flama dimmable E14 | Flama deco transparent E27 |
| Power | 5,5W | 5,5W | 4W |
| Color Temperature | 2.700K / 3.000K / 5.000K | 3.000K | 2.700K |
| Lumens | 450 lm / 500 lm / 550 lm | 418 lm | 330 lm |
| Code | 592122-FL2 2.700K E14 592122-FL2E 2.700K E27 592122-FL3 3.000K E14 592122-FLE3 3.000K E27 3534 5.000K E14 | 592122R-C3 3.000K | 592122FD1T-4C 2.700K |





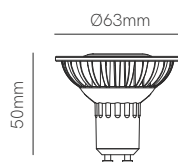

3 YEARS WARRANTY | 25.000 HOURS | IP 40 | 220/240 VAC | PF >0,8 | CRI ≥80 | 360°  | 50/60 Hz |  +40°C / -20°C |  10/50

R-63 s-line

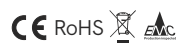
Technical Information

| | |
|-------------------|------------------|
| Version | R-63 s-line GU10 |
| Power | 8W |
| Color Temperature | 2.700K |
| Lumens | 720 lm |
| Code | 4003 |



5 YEARS WARRANTY | 50.000 HOURS | IP 20 | 220/240 VAC | PF >0,8 | CRI ≥80 | 60°  | 50/60 Hz |  +40°C / -20°C | 

R-39

R-50

R-63

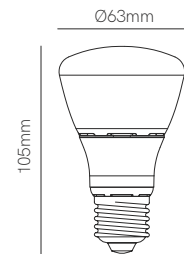
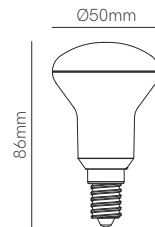
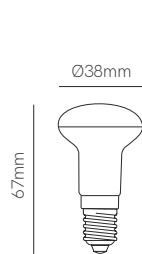

Technical Information

| | | | |
|-------------------|-------------|--------------|----------|
| Version | R-39 E14 | R-50 E14 | R-63 E27 |
| Power | 3W | 5W | 8W |
| Color Temperature | 3.000K | 3.000K | 3.000K |
| Lumens | 308 lm | 385 lm | 660 lm |
| Code | 592122R39-2 | 5920731-(N2) | 592072-1 |
| | IP 40 | IP 40 | IP 20 |



3 YEARS WARRANTY | 25.000 HOURS | 220/240 VAC | PF >0,8 | CRI ≥80 | 120° | 50/60 Hz | +40°C -20°C | 10/50

R-80



R-90 2.200K



R-90 3.000K

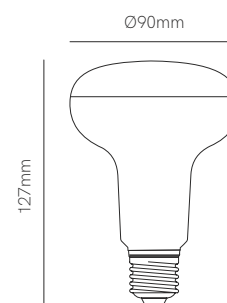
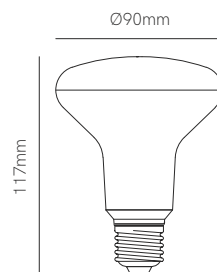
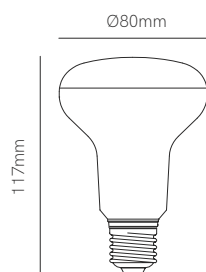

Technical Information

| | | | |
|-------------------|--------------|-------------|-------------|
| Version | R-80 | R-90 2.200K | R-90 |
| Power | 10W | 12W | 12W |
| Color Temperature | 3.000K | 2.200K | 3.000K |
| Lumens | 891 lm | 850 lm | 1.100 lm |
| Code | 592076-C3(N) | 4137 | 592074-C(N) |

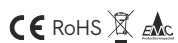

3 YEARS WARRANTY | 25.000 HOURS | IP 40 | 220/240 VAC | PF >0,8 | CRI ≥80 | 120° | 50/60 Hz | +40°C / -20°C | 10/40

Par 30

Par 38 3.000K

Par 38 Green

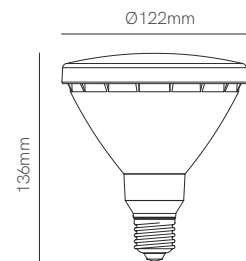
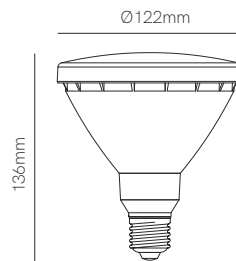
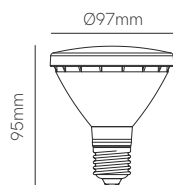

Technical Information

| | | | |
|-------------------|-------------|-------------------|------------------|
| Version | Par 30 E27 | Par 38 3.000K E27 | Par 38 Green E27 |
| Power | 10W | 15W | 15W |
| Color Temperature | 3.000K | 3.000K | Green |
| Lumens | 660 lm | 1.100 lm | 190 lm |
| Code | 171160P30-C | 171160P38(N)-C | 3579 |





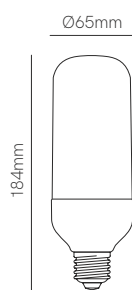

3 YEARS WARRANTY | 25.000 HOURS | IP 65 | 220/240 VAC | PF >0,8 | CRI ≥80 | 50/60 Hz | +40°C -20°C | 10/40

 Sil

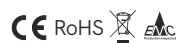
 Technical Information

| | |
|-------------------|--|
| Version | Sil E27 |
| Power | 20W |
| Color Temperature | 2.700K / 4.000K |
| Lumens | 2.035 lm / 2.550 lm |
| Code | 592165SIL-C 2.700K 592165SIL-F 4.000K |



3 YEARS WARRANTY | 25.000 HOURS | IP 40 | 220/240 VAC | PF >0,9 | CRI ≥85 | 360°  | 50/60 Hz |  +40°C / -20°C | 

Aria 30W

Aria 50W

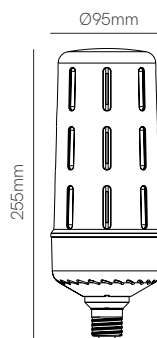
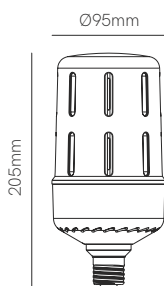

Technical Information

| | | |
|-------------------|--|--|
| Version | Aria 30W E27 / E40 | Aria 50W E27 / E40 |
| Power | 30W | 50W |
| Color Temperature | 2.700K / 5.000K | 2.700K / 5.000K |
| Lumens | 3.100 lm / 3.550 lm | 5.400 lm / 6.200 lm |
| Code | 3854 2.700K E27 3856 2.700K E40 3855 5.000K E27 3857 5.000K E40 | 3858 2.700K E27 3860 2.700K E40 3859 5.000K E27 3861 5.000K E40 |

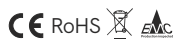

3 YEARS WARRANTY | 25.000 HOURS | IP 20 | 220/240 VAC | PF >0,9 | CRI ≥80 | 360° | 50/60 Hz | +40°C / -20°C | > 1KV | ENCLOSED NO | 6/24

Cup 45W

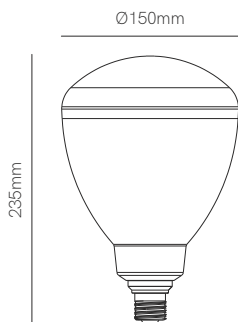

Technical Information

| | |
|-------------------|------------------------|
| Version | Cup 45W E27 / E40 |
| Power | 45W |
| Color Temperature | 3.000K |
| Lumens | 3.960 lm |
| Code | 592141-C3E2 3.000K E27 |
| | 592141-E4C3 3.000K E40 |

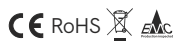



3 YEARS WARRANTY | 25.000 HOURS | IP 40 | 220/240 VAC | PF >0,8 | CRI ≥80 | 100° | 50/60 Hz | +40°C / -20°C | ENCLOSED NO | |

Moon



 Technical Information

| | |
|-------------------|--------------------|
| Version | Moon 50W E27 / E40 |
| Power | 50W |
| Color Temperature | 4.000K |
| Lumens | 7.250 lm |
| Code | 4028 4.000K |

CE RoHS  

5 YEARS WARRANTY | 50.000 HOURS | IP 42 | 100/240 VAC | PF >0,9 | CRI ≥85 | 115°  | 50/60 Hz |  +60°C / -40°C | > 4KV  | ENCLOSED OK  |  4

Noa 80W

Noa 85W

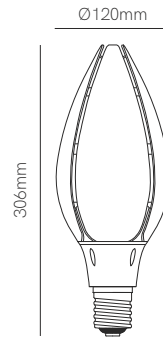
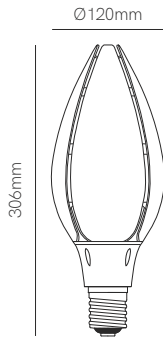

Technical Information

| | | |
|-------------------|----------------------|--|
| Version | Noa 80W E27 / E40 | Noa 85W E27 / E40 |
| Power | 80W | 85W |
| Color Temperature | 2.200K | 2.700K / 5.000K |
| Lumens | 5.900 lm | 9.700 lm / 10.200 lm |
| Code | 3965 2.200K E27/ E40 | 3902 2.700K E27 3900 2.700K E40 3903 5.000K E27 3901 5.000K E40 |

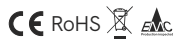

3 YEARS WARRANTY | 25.000 HOURS | IP 65 | 100/260 VAC | PF >0,9 | CRI ≥80 | 360° | 50/60 Hz | +40°C / -20°C | ENCLOSED NO | 8



Smile 20W

Smile 40W

Smile 60W

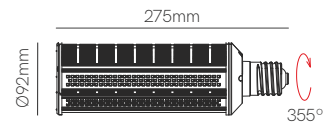
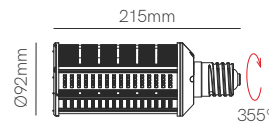
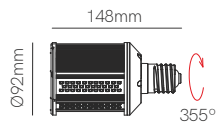
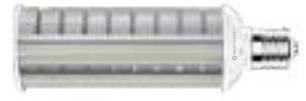

Technical Information

| | | | |
|-------------------|---------------------|---------------------|---------------------|
| Version | Smile 20W E27 | Smile 40W E27 | Smile 60W E40 |
| Power | 20W | 40W | 60W |
| Color Temperature | 2.200K / 5.000K | 2.200K / 5.000K | 2.200K / 5.000K |
| Lumens | 2.000 lm / 3.000 lm | 4.000 lm / 6.000 lm | 6.000 lm / 9.000 lm |
| Code | 3913 2.200K | 3914 2.200K | 3915 2.200K |
| | 3925 5.000K | 3926 5.000K | 3927 5.000K |
| | 24 | 12 | 12 |

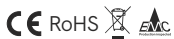

5 YEARS WARRANTY | 50.000 HOURS | IP 64 | 100/240 VAC | PF >0,9 | CRI ≥70 2.200K | CRI ≥80 5.000K | 120° | 50/60 Hz | +60°C / -40°C | >4KV | ENCLOSED OK

Obo 19W

Obo 27W

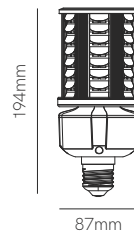
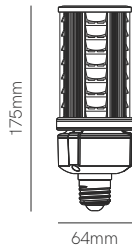

Technical Information

| | | |
|-------------------|----------------------------|----------------------------|
| Version | Obo 19W E27 | Obo 27W E27 |
| Power | 19W | 27W |
| Color Temperature | 2.200K / 5.000K | 2.200K / 5.000K |
| Lumens | 1.425 lm / 1.900 lm | 2.025 lm / 3.000 lm |
| Code | 3909 2.200K 3917 5.000K | 3910 2.200K 3918 5.000K |

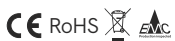

5 YEARS WARRANTY | 50.000 HOURS | IP 64 | 100/240 VAC | PF >0,9 | CRI ≥70 2.200K | CRI ≥80 5.000K | 170° | 50/60 Hz | +60°C -40°C | >4KV | ENCLOSED OK | 16

Obo 36W Obo 45W

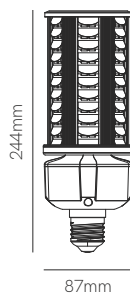
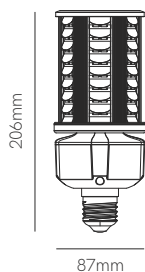

Technical Information

| | | |
|-------------------|--|--|
| Version | Obo 36W E27 / E40 | Obo 45W E27 / E40 |
| Power | 36W | 45W |
| Color Temperature | 2.200K / 5.000K | 2.200K / 5.000K |
| Lumens | 2.700 lm / 3.900 lm | 3.375 lm / 4.500 lm |
| Code | 3911 2.200K E27 3920 2.200K E40 3919 5.000K E27 3921 5.000K E40 | 3912 2.200K E27 3923 2.200K E40 3922 5.000K E27 3924 5.000K E40 |

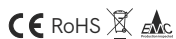

5 YEARS WARRANTY | 50.000 HOURS | IP 64 | 100/240 VAC | PF >0,9 | CRI ≥70 2.200K | CRI ≥80 5.000K | 170° | 50/60 Hz | +60°C / -40°C | >4KV | ENCLOSED OK | 16

Conditions



PRICES UPDATE - INTERNET UPDATE - PDF

Our interest in new solutions and for the development of lighting technology and lighting industry, we are constantly innovating. This is why BENEITO FAURE offers to its customers a frequently online updated PDF to inform about all our news.

You can find all the information on our website:

www.beneito-faure.com

IMPORTANT:

All information on the website can be cancelled and replaced by another one, and will be the last update the only right one.

For this reason is very important to visit our web.



TARIFA BENEITO FAURE - ACTUALIZACIÓN DIGITAL - PDF

Nuestra implicación desde BENEITO FAURE por una continua elaboración de soluciones avanzadas, junto al progresivo cambio tecnológico de la industria de la iluminación en los últimos años, nos hace estar en constante innovación.

Por ello, ponemos al servicio de todos nuestros clientes una actualización frecuente on-line (formato PDF) con la intención de tenerlos informados en todo momento de las últimas novedades de BENEITO FAURE.

La mencionada actualización se encuentra disponible en nuestra página WEB:

www.beneito-faure.com

IMPORTANTE:

Cualquier información publicada quedará anulada y sustituida por la que aparece en cada momento en nuestra WEB, siendo esta la única con validez y vigencia de gama y precios de venta recomendados.

Por ello, desde Beneito Faure recomendamos a todos nuestros clientes visiten nuestra página web.



GENERAL CONDITIONS OF SALE

BENEITO FAURE S.L reserves the right to make the variations it deems appropriate to its products, not being responsible for the possible erroneous information that appears in the catalog.

RATE

For any type of order the rate and conditions in force at the time of receipt of the order will apply. The rate will be sent via email to all customers in the BENEITO FAURE database and will be updated whenever necessary. Prices do not include VAT if recycling rate.

ORDERS

Orders must be sent via email. No order will be placed by phone or any other means. The quote of the material to be made to measure will be sent to the customer for acceptance and will not be processed prior receiving the copy signed for acceptance.

RETURNS

To make any return, the authorization must be requested from BENEITO FAURE. The return of the material must be communicated by e-mail indicating the customer's name, the reason of the return, the date of purchase, the number of units and the reference of the product to be returned. It is mandatory to attach a copy of the purchase invoice. The acceptance of the return does not imply the definitive acceptance of it. The return will be definitive only after the subsequent verification and analysis of the product by our technical department. Returns of merchandise will only be accepted if in perfect condition for sale and in the original packaging in good condition. The packaging label must also be intact. Returns will not be compensated by an economic amount and must be sent by means of the client's transport. The return of material may be compensated by prior order and with the authorization of BENEITO FAURE. The return of the products made to measure or previously processed by the technical department due to the customer's request, will not be accepted.

TRANSPORT

Unless other transport terms are agreed, the merchandise will travel on behalf of those purchased with the EXWORKS conditions. Likewise, BENEITO FAURE will offer a delivery time for each territory, this being always approximate. The company will not be responsible for possible alterations or delays on this time caused by causes outside the company.

PROPERTY RESERVATION

BENEITO FAURE reserves the right to own all the materials that it supplies until the buyer has paid the total amount thereof.

The requested goods are supplied under reservation of ownership in favor of BENEITO FAURE

The client is obliged to cooperate and take all steps necessary or desirable, and to propose or need to BENEITO safeguard their ownership of the goods. The serve of domain remains even in the event that the client had accepted and recognized credits against BENEITO or had established a system of accounts between them. The transformation or improvement of goods on which BENEITO has reserve domain, does not give property to client or manipulative. In case of union, transformation and/or accession of goods under domain's reserve to thirds, subsist the domain's reserve in proportion to the value that the goods subject had to domain's reserve before to accession. The client may sell the goods subject to domain's reserve in the ordinary course of business, provided those no breach his payment obligations to BENEITO. Upon a resale of goods subject to domain's reserve, occurs automatically the transfer to BENEITO of credits arising of that sale to the seller, and any other credit arising in the case of compensation for loss of thing, tort-contract, etc. in such cases, the client is obliged to BENEITO to provide all information and documentation necessary for the claim of the subrogated credits. In case of default by the client, in particular, in the case of late payment, or if a declaration of bankruptcy of the client, BENEITO claim by notifying the client, in possession of the goods, being obligated to BENEITO to provide all information and documentation necessary for the claim of the subrogated credits. In case of default by the client, in particular, in the case of late payment, or if a declaration of bankruptcy of the client, BENEITO claim by notifying the client, in possession of the goods, being obliged it to give them. If before performed the pay of total price, the goods sold were affected by some lien or lock, the client shall be obliged to sate explicitly in the diligence of the embargo, that the goods are owned by BENEITO and if, despite this, were seized, must facilitate to BENEITO the exercise by the relevant third domain action, whose expenses will be paid by the client.

DELIVERY TERM

The availability terms offered by BENEITO FAURE are always approximate and may be subject to variations. These possible variations in the terms will not imply the acceptance of the responsibility or penalties for the delay by BENEITO FAURE.

CLAIMS

On the delivery note of the carrier, any visible anomaly must be recorded and, after having reviewed the material, communicate in writing to our offices the incident within 24 hours of receiving the merchandise. Once this time has elapsed, the company will not be able to take charge of the claim because it is not in time for the transport agency. For other types of claims, you must contact our offices by written email. The product that does not work correctly will be replaced by the same article or another with the same characteristics. In no case will we be responsible for the costs of labor that may be caused by the malfunction of a product in our catalog.

WARRANTY

BENEITO FAURE guarantees that the products sold are in perfect condition. The warranty will cover the repair or replacement of the product (under the decision of BENEITO FAURE) and it will be necessary to send the incident by email. The product warranty is in its packaging. The technical department of BENEITO FAURE will be the only one authorized to determine if it is a manufacturing defect, after receiving the incident and the sales invoice in writing for prior verification. BENEITO FAURE quantifies the warranty time considering the date of the customer's purchase invoice and not on the hours of operation of the product.

The WARRANTY will not be covered:

1. If the product has been previously handled.
2. It is not installed according to the instructions.
3. If the ventilation of which is not adequate.
4. Problems with partial or total payment by the client.

JURISDICTION

In any discrepancy or dispute, both parties will submit to the jurisdiction of the Judges and courts of Barcelona.



ALLGEMEINE GESCHÄFTSBEDINGUNGEN

BENEITO FAURE S.L behält sich das Recht, etwaige, für erforderlich gehaltene Änderungen an den Produkten vorzunehmen, und ist nicht für mögliche Fehlinformationen im entsprechenden Katalog haftbar.

PREISLISTE

Alle Bestellungen unterliegen der zum Zeitpunkt der Bestellung geltenden Preisliste und den entsprechenden Geschäftsbedingungen. Die Preisliste wird per E-Mail an alle Kunden, die sich in der Datenbank von BENEITO FAURE befinden, geschickt und wird, wenn erforderlich, entsprechend aktualisiert werden. Die Preise enthalten weder die Mehrwertsteuer noch die Recyclinggebühr.

BESTELLUNGEN

Bestellungen müssen per E-Mail geschickt werden. Es werden keine Bestellungen telefonisch oder auf sonstigem Wege entgegengenommen. Der Kostenvoranschlag bzw. das Angebot für das nach Kundenvorgaben anzufertigende Produkt, wird dem Kunden zur Prüfung und zur Freigabe zugesandt und wird erst nach Erhalt der geprüften Auftragsfreigabe bearbeitet.

RÜCKGABEN

Alle Rückgaben müssen vorab bei BENEITO FAURE beantragt und von der Firma genehmigt werden. Die Rücksendung-Anfrage des Materials muss per E-Mail unter Angabe des Kundennamens, des Grundes der Rücksendung, des Kaufdatums, der Anzahl der Einheiten und der Referenz des zurückzusendenden Produkts erfolgen. Es ist zwingend erforderlich, eine Kopie der Kaufrechnung beizufügen. Die Annahme der Rücksendung bedeutet nicht die endgültige Annahme. Die Rücksendung ist erst nach der anschließenden Überprüfung und Analyse des Produkts durch unsere technische Abteilung endgültig. Warenrücksendungen werden nur akzeptiert, wenn sie sich in einwandfreiem Zustand zum Verkauf und in der Originalverpackung in gutem Zustand befinden. Das Verpackungsetikett muss ebenfalls intakt sein. Rückgaben werden nicht durch einen Geldbetrag ausgeglichen und müssen vom Kunden mit eigenen Transportmitteln geschickt werden. Die Materialrückgabe kann, nach Genehmigung von BENEITO FAURE, durch eine Vorbestellung ausgeglichen werden. Die Rücksendung der nach Maß gefertigten oder zuvor von der technischen Abteilung auf Kundenwunsch gefertigten Produkte wird nicht akzeptiert.

TRANSPORT

Außer im Falle von gesondert vereinbarten Transportbedingungen, wird die Ware unter ex-works Bedingungen zu Lasten des Käufers versendet werden. BENEITO FAURE wird die Lieferzeiten stets dem Empfangsort entsprechend angeben, wobei es sich immer um annähernde Zeiten handeln wird. Das Unternehmen ist nicht für etwaige Änderungen oder Verspätungen haftbar, die sich aus Gründen, die nicht vom Unternehmen zu verantworten sind, ergeben.

EIGENTUMSVORBEHALT

BENEITO FAURE behält sich das Eigentumsrecht auf alle gelieferten Materialien, bis der Käufer den gesamten Kaufbetrag beglichen hat.

Die bestellten Waren werden unter Eigentumsvorbehalt zu Gunsten von BENEITO geliefert, bis der Kunde allen Zahlungsverpflichtungen nachgekommen ist. Der Kunde verpflichtet sich, zu kooperieren und alle notwendigen oder angemessenen Maßnahmen und solche Maßnahmen, die BENEITO vorschlägt oder benötigt, zu ergreifen, um sein Eigentum über die Ware zu schützen. Der Eigentumsvorbehalt besteht selbst dann weiter, wenn der Kunde akzeptierte und anerkannte Forderungen gegenüber BENEITO hätte, oder wenn ein System laufender Konten zwischen beiden Parteien bestünde. Die Transformation oder Verbesserung der Ware für die BENEITO einen Eigentumsvorbehalt hat, überträgt sein Eigentum nicht an den Kunden oder den Anwender. Im Falle von Zusammenführung, Transformation und/oder Beistellung von Produkten unter Eigentumsvorbehalt mit Produkten von Dritten besteht der Eigentumsvorbehalt in Proportion entsprechend dem Wert, den die Produkte mit Eigentumsvorbehalt vor der Beistellung hatten, fort. Der Kunde kann die Waren unter Eigentumsvorbehalt im Rahmen seiner gewöhnlichen Geschäfte verkaufen, solange er seinen Zahlungsverpflichtungen gegenüber BENEITO nachkommt. In jedem Fall erfolgt bei einem Wiederverkauf der Waren unter Eigentumsvorbehalt automatisch eine Abtretung der aus diesem Wiederverkauf entstehenden Forderungen zugunsten des Verkäufers an BENEITO, sowie eine Abtretung aller anderen Forderungen, die ggf. als Entschädigungen durch Warenverlust, außervertragliche Haftung usw. entstehen. Der Kunde ist in diesen Fällen dazu verpflichtet, BENEITO alle für die Reklamation der übertragenen Forderungen notwendigen Informationen und Unterlagen zur Verfügung zu stellen. Im Falle einer Nichteinhaltung seitens des Kunden, und insbesondere im Fall von verspäteten Zahlungen oder Konkurserklärung seitens des Kunden, reklamiert BENEITO als Eigentümer der Ware, nach vorheriger Mitteilung an den Kunden, die Zurückgabe der Ware seitens des Kunden. Sollte die verkaufte Ware vor der vollständigen Bezahlung des Preises Gegenstand von Pfändung oder Handelshemmnis werden, ist der Kunde verpflichtet, bei der Pfändungsmaßnahme ausdrücklich darauf hinzuweisen, dass die Waren Eigentum von BENEITO sind und, sollten sie trotz dieser Erklärung gepfändet werden, die Durchführung des entsprechenden Drittwiderspruchs, dessen Kosten zu Lasten des Kunden gehen, seitens BENEITO zu ermöglichen.

LIEFERZEIT

Die von BENEITO FAURE genannten Lieferzeiten und Verfügbarkeiten verstehen sich immer als ca. Angaben und können Änderungen unterliegen. Diese möglichen Änderungen der Lieferzeiten bedeuten nicht die Anerkennung der Verantwortung oder die Auferlegung einer Strafe als Folge des Verzugs durch BENEITO FAURE.

REKLAMATIONEN

Jegliche sichtbaren Mängel müssen auf dem Lieferschein des Transportunternehmens eingetragen werden. Nach Prüfung der Ware, müssen etwaige Vorfälle unserer Firma innerhalb der nächsten 24 Stunden schriftlich mitgeteilt werden. Nach dieser Frist übernimmt die Firma keine Haftung für Reklamationen, da die vom Transportunternehmen vorgeschriebene Frist abgelaufen ist. Im Falle sonstiger Reklamationen müssen diese unserer Verwaltung schriftlich mitgeteilt werden. Produkte, die nicht korrekt funktionieren, werden durch gleiche Produkte, oder Produkte mit den gleichen Eigenschaften, ersetzt. In keinem Fall werden wir die Arbeitskosten übernehmen, die sich aus der Fehlfunktion eines Produkts aus unserem Katalog ergeben könnten.

GARANTIE

BENEITO FAURE garantiert, dass die verkauften Produkte sich in perfektem Zustand befinden. Die Garantie deckt die Reparatur oder den Ersatz des Produkts (nach Entscheidung von BENEITO FAURE). Der Fall muss jedoch vorab per E-Mail angezeigt werden. Die Produktgarantie befindet sich in der Produktverpackung. Die technische Abteilung von BENEITO FAURE ist die einzige autorisierte Stelle, um die Entscheidung zu treffen, ob es sich um einen Herstellungsfehler handelt, nachdem der Fall schriftlich gemeldet wurde, samt Rechnung, zur entsprechenden Prüfung.

BENEITO FAURE bewertet die Garantiezeit unter Berücksichtigung des Datums der Kaufrechnung des Kunden und nicht anhand der Betriebsstunden des Produktes.

Die GARANTIE gilt nicht:

1. Wenn das Produkt manipuliert wurde.
2. Wenn das Produkt nicht gemäß Anleitungen installiert wurde.
3. Wenn die Produktbelüftung nicht geeignet ist.
4. Wenn Probleme für die teilweise oder vollständige Zahlung durch den Kunden vorliegen.

GERICHTSBARKEIT

Im Falle etwaiger Uneinigkeiten oder Streitfälle, werden sich beide Parteien der Gerichtsbarkeit der Richter und Gerichte von Barcelona unterwerfen.



CONDITIONS GÉNÉRALES DE VENTE

BENEITO FAURE S.L. se réserve le droit de faire les variations qu'elle juge appropriées à ses produits n'étant pas responsable de toute information erronée qui apparaît dans le catalogue.

TARIF

Pour tout type de commande, nous appliquerons les tarifs et conditions en vigueur au moment de la réception de la commande. Le tarif sera envoyé par e-mail à tous les clients qui sont dans la base de données de BENEITO FAURE et sera mis à jour si nécessaire. Les prix n'incluent pas la TVA.

COMMANDES

Les commandes doivent être envoyées par EMAIL. Aucune commande ne sera passée par téléphone ou par tout autre moyen. Les devis de matériel qui doit être manipulé sur mesure seront soumis au client pour validation et ne seront pas traités avant de recevoir la copie signée du bon pour accord.

RETOURS

Pour tout retour, une autorisation préalable doit être demandée à BENEITO FAURE. Il faudra communiquer le motif du retour par courrier électronique en indiquant le nom du client, la date d'achat, les unités et la référence du produit retourné, le motif du retour et le bon de livraison concerné. L'acceptation du retour n'implique pas l'acceptation définitive de celui-ci. Le retour ne sera définitif qu'après vérification et analyse du produit par notre service technique. Les retours de marchandises ne seront acceptés que si le matériel est en parfait état pour la vente et dans son emballage d'origine en bon état, ainsi que l'étiquette de l'emballage. Les retours ne seront pas compensés par un montant économique et ils devront être envoyés par le biais du transport du client. Le retour du matériel peut être compensé au moyen d'une commande préalable et avec l'autorisation de BENEITO FAURE. Nous n'accepterons pas les retours de produits de fabrication spéciale ou préalablement manipulés par le service technique à la demande du client.

TRANSPORT

Sauf convention contraire, les marchandises voyagent pour le compte de ceux qui achètent aux conditions EXWORKS. De même, BENEITO FAURE proposera un délai de livraison pour chaque territoire, toujours approximatif. La société ne sera pas responsable d'éventuelles modifications ou retards sur ce délai produits par des causes externes à la société.

RÉSERVE DE PROPRIÉTÉ

BENEITO FAURE se réserve la propriété de tous les matériaux qu'elle fournit jusqu'au paiement intégral par l'acheteur.

La marchandise commandée est livrée sous réserve de propriété en faveur de BENEITO FAURE jusqu'à l'exécution complète des obligations de paiement du client.

Le client est tenu de coopérer et de prendre les mesures nécessaires et celles que BENEITO FAURE propose pour préserver sa propriété des marchandises. La réservation du domaine persiste même si le client a accepté et reconnu des crédits sur BENEITO FAURE ou si un système de comptes courants a été établi entre eux. La transformation ou l'amélioration de la marchandise sur laquelle BENEITO FAURE a une réserve de propriété ne confère pas sa propriété au client ou au manipulateur. Toute supposition d'union, de transformation et/ou d'adhésion des produits sous la réserve de dominion aux produits de tiers subsistera la réserve de dominion dans la proportion correspondant à la valeur qui avait les produits objet de la réserve de dominion avant l'adhésion. Le client peut vendre la marchandise sous réserve de propriété dans le cours normal de ses affaires, à condition qu'il n'ait pas manqué à ses obligations de paiement envers BENEITO FAURE. En tout état de cause, en cas de revente de marchandises sous réserve de propriété, il y a cession de plein droit à BENEITO FAURE des crédits nés de cette revente en faveur du vendeur, ainsi que de tous autres crédits antérieurs, en cas d'indemnisation pour perte de la chose, responsabilité civile, etc. Dans ces cas, le client sera tenu de fournir à BENEITO FAURE toutes les informations et documents nécessaires à la réclamation des crédits subrogés. En cas de non-respect de la part du client, et notamment en cas de retard de paiement ou de déclaration de faillite du client, BENEITO FAURE se réserve le droit de réclamer, moyennant notification préalable au client, la possession des marchandises, le client étant tenu de les lui livrer. Si, avant le paiement intégral du prix, les marchandises vendues font l'objet d'une saisie ou d'un empêchement, le client est tenu de déclarer expressément, dans le cadre de la saisie, que les marchandises sont prioritaires pour BENEITO FAURE et si, malgré cette déclaration, elles sont saisies, BENEITO FAURE pourra exercer l'action correspondante du tiers, dont les frais seront à charge du client.

TEMPS DE LIVRAISON

Les périodes de disponibilité offertes par BENEITO FAURE sont toujours approximatives et peuvent faire l'objet de variations. Ces éventuelles variations de conditions n'impliquent pas l'acceptation de responsabilité ou de pénalités de retard de la part de BENEITO FAURE.

RÉCLAMATIONS

Le bon de livraison du transporteur doit mentionner toute anomalie visible et, après examen du matériel, communiquer par écrit à nos bureaux l'incident dans les 24 heures suivant la réception des marchandises. Passé ce délai, l'entreprise ne pourra pas prendre en charge la réclamation pour ne pas être dans le délai par l'agence de transport. Pour les autres types de réclamations, vous devez communiquer par écrit à nos bureaux. Le produit qui ne fonctionne pas correctement sera remplacé par un autre égal ou qui remplit les mêmes caractéristiques. En aucun cas nous ne prendrons en charge les coûts de main d'œuvre qui peuvent être occasionnés par le dysfonctionnement d'un produit de notre catalogue.

GARANTIE

BENEITO FAURE garantit que les produits vendus sont en parfait état. La garantie couvrira la réparation ou le remplacement du produit (à la discrétion de BENEITO FAURE) et il sera nécessaire d'envoyer l'incident par email. La garantie du produit se trouve sur l'emballage du produit. Le service technique de BENEITO FAURE sera le seul autorisé à déterminer s'il s'agit d'un défaut de fabrication, après avoir reçu par écrit l'incidence et la facture de vente pour vérification préalable. BENEITO FAURE base la période de garantie sur les années écoulées depuis l'achat du produit par le client, et non sur les heures d'utilisation du produit.

La GARANTIE ne sera pas couverte :

1. Si le produit a déjà été manipulé.
2. N'a pas été installé conformément aux instructions.
3. Si la ventilation n'est pas suffisante.
4. Problèmes de paiement partiel ou total par le client.

JURIDICTION

En cas de désaccord ou de litige, les deux parties se soumettront à la juridiction des juges et tribunaux de Barcelone.



CONDIZIONI GENERALI DI VENDITA

BENEITO FAURE S.L. si riserva il diritto di realizzare le variazioni che considera opportune sui propri prodotti non essendo responsabile di possibili informazioni errate che possono apparire nel catalogo.

LISTINO PREZZI

Per qualsiasi ordine si applicano le condizioni di vendita in vigore al momento della ricezione dello stesso. Il listino prezzi è inviato tramite mail a tutti i clienti inseriti nel data base di BENEITO FAURE e può essere aggiornato in qualsiasi momento se necessario. I prezzi sono da intendersi IVA esclusa. Tassa di riciclaggio inclusa.

ORDINI

Gli ordini devono essere inviati esclusivamente tramite mail. Non sarà processato nessun ordine via telefono o tramite altri mezzi. I preventivi del materiale che deve essere fatto su misura saranno inviati al cliente per accettazione e non saranno elaborati fino al ricevimento della copia firmata per accettazione.

RESI

Per procedere con qualsiasi reso è necessario ricevere l'autorizzazione di BENEITO FAURE. Il motivo del reso deve essere comunicato tramite e-mail indicando il nome del cliente, la data di acquisto, le unità ed il riferimento del prodotto da rendere. È obbligatorio allegare sempre la copia della fattura d'acquisto. L'accettazione del reso non implica l'accettazione definitiva dello stesso. Il reso sarà definitivo solo dopo la successiva verifica ed analisi del prodotto da parte del nostro ufficio tecnico. I resi di merce saranno accettati solo se in perfette condizioni per la vendita e nella confezione originale in buone condizioni. Anche l'etichetta dell'imballo deve essere integra. I resi non vengono rimborsati e devono essere spediti unicamente dal cliente all'azienda. I resi vengono compensati con articoli sostitutivi tramite autorizzazione di BENEITO FAURE. Non saranno accettati resi di prodotti fatti su misura o precedentemente trattati dall'ufficio tecnico su richiesta del cliente.

CONSEGNA

A meno che non si accordino speciali condizioni e termini, il trasporto è a carico del destinatario: EX-WORKS. Alternativamente BENEITO FAURE dispone di un servizio di consegna per ogni territorio e la resa ed il presso variano a seconda della destinazione. L'azienda non si fa carico di eventuali danni o alterazioni subiti dalla merce durante il trasporto non imputabili dall'azienda stessa.

DIRITTO DI PROPRIETÀ

BENEITO FAURE si riserva il diritto e la proprietà di tutto il materiale che somministra fino al momento in cui il cliente finale abbia totalmente pagato il materiale stesso.

La merce si somministra sotto la riserva di proprietà di BENEITO FAURE fino al totale adempimento delle obbligazioni da parte del cliente.

Il cliente è obbligato a cooperare e adottare tutte le misure necessarie o convenienti e quelle proposte da BENEITO FAURE per salvaguardare la sua proprietà del prodotto. La riserva di proprietà persiste anche quando viene accettato e riconosciuto il credito del cliente da BENEITO FAURE o se si fosse stabilito un sistema di pagamento tra le parti. Le trasformazioni o i miglioramenti della merce sulla quale BENEITO FAURE ha la riserva di proprietà, non assegnano la proprietà al cliente o al manipolatore. In caso di unione, trasformazione e/o adesione dei prodotti sotto la proprietà di terzi sussisterà la riserva di proprietà in proporzione al valore che avevano i prodotti oggetto di riserva di proprietà prima dell'adesione. Il cliente potrà vendere i beni soggetti a riserva di proprietà nell'ambito dei suoi affari, sempre e quando non ci siano violazioni delle obbligazioni nei confronti di BENEITO FAURE. In tutti i casi quando si genera una rivendita di merce soggetta a diritto di proprietà, si genera automaticamente la cessazione a BENEITO FAURE dei crediti conseguenti alla rivendita in favore del venditore, così come si qualsiasi altro credito precedente, nel suo caso di indennizzo per perdita della cosa, responsabilità extra-contrattuale, ecc. Il cliente sarà obbligato in questo caso a fornire a BENEITO FAURE tutte le informazioni e i documenti necessari per i reclami. BENEITO FAURE reclamerà, previa notifica del cliente in possesso della merce, essendo quest'ultimo obbligato a fornirli. Se prima di effettuare il pagamento totale, la merce venduta fosse soggetta a qualsiasi tipo di sequestro o blocco, il cliente sarà obbligato a dichiarare nel documento di sequestro che la merce è proprietà di BENEITO FAURE e se, indipendentemente da questo la merce fosse sequestrata, il cliente deve supportare BENEITO FAURE alla rivalsa del diritto di proprietà le cui spese saranno a carico del cliente.

TEMPI DI CONSEGNA

I tempi di consegna offerti da BENEITO FAURE sono sempre approssimati e possono essere soggetti a variazioni. Queste possibili variazioni non implicano l'accettazione di eventuali responsabilità o penalizzazioni subite a cause del ritardo di BENEITO FAURE.

RECLAMI

Nel documento di trasporto dell'autista deve essere segnalata qualsiasi visibile anomalia. Deve essere effettuato il controllo della merce e segnalato all'azienda entro e non oltre le 24 ore dalla ricezione. Superato questo tempo, l'azienda non si farà carico del reclamo per il ritardo dovuto all'agenzia di trasporto. Qualsiasi altro reclamo dovrà essere trasmesso in forma scritta all'azienda. Il prodotto non funzionante sarà sostituito con il corrispettivo uguale o che presenti le medesime caratteristiche. In nessun caso l'impresa si farà carico dei costi sostenuti per il mal funzionamento di un prodotto del nostro catalogo.

GARANZIA

Beneito Faure garantisce che i prodotti vengono venduti in perfetto stato. La garanzia copre la riparazione o la sostituzione del prodotto (sotto conferma di BENEITO FAURE) ed è necessario l'invio della contestazione via mail. La garanzia del prodotto si trova all'interno dell'imballo. Il dipartimento tecnico di BENEITO FAURE sarà l'unico autorizzato a determinare se si tratta di un difetto di fabbricazione, dopo aver ricevuto in forma scritta la contestazione e la fattura di vendita per poter verificare l'effettivo periodo di garanzia. BENEITO FAURE quantifica il tempo di garanzia considerando la data della fattura di acquisto del cliente e non sulle ore di funzionamento del prodotto.

La GARANZIA non sarà valida se:

1. Il prodotto viene manomesso o manipolato
2. Il prodotto non è installato come da istruzioni
3. La ventilazione del prodotto non è adeguata
4. Il cliente ha problemi con i pagamenti, sia in forma parziale che totale.

FORO DI COMPETENZA

In qualunque caso di discrepanza o controversia, ambe le parti si dovranno riferire al foro di competenza dei Giudici e del Tribunale di Barcellona.



CONDICIONES GENERALES DE VENTA

BENEITO FAURE S.L se reserva el derecho a realizar las variaciones que considere oportunas a sus productos no siendo responsables de la posible información errada que aparezca en dicho catálogo.

TARIFA

Para cualquier tipo de pedido se aplicará la tarifa y condiciones vigentes en el momento de la recepción del pedido. La tarifa se enviará vía email a todos los clientes que se encuentren en la base de datos de BENEITO FAURE y será actualizada siempre que sea necesario. Los precios no incluyen IVA ni tasa de reciclaje.

PEDIDOS

Los pedidos deberán ser enviados vía email. No se cursará ningún pedido por teléfono o cualquier otra vía. Los presupuestos de material que se deba manipular a medida se enviarán al cliente para su aceptación y no se cursaran hasta recibir la copia firmada de la aceptación.

DEVOLUCIONES

Para realizar cualquier devolución se deberá solicitar la autorización previa a BENEITO FAURE. Deberá comunicarse el motivo de la devolución vía email indicando el nombre del cliente, fecha de compra, unidades y referencia del producto devuelto, motivo de la devolución y albarán de compra. La aceptación de la devolución no implica la aceptación definitiva de ésta. Dicha devolución solo será definitiva tras la consiguiente verificación y análisis del producto por parte de nuestro departamento técnico. Solo serán aceptadas las devoluciones de mercancía si ésta se encuentra en perfecto estado para su venta y en su embalaje original en buen estado, así como la etiqueta de embalaje. Las devoluciones no serán compensadas mediante un importe económico. La devolución de material podrá ser compensada mediante un pedido previo y con la autorización de BENEITO FAURE. No se aceptarán devoluciones de productos de fabricación especial o previamente manipulados por parte del departamento técnico bajo petición del cliente.

TRANSPORTE

Salvo que se acuerden otros términos de transporte, la mercancía viajará por cuenta de los comprados con las condiciones EXWORKS. Así mismo, BENEITO FAURE ofrecerá un tiempo de entrega por cada territorio, siendo éste siempre aproximado. La empresa no se hará cargo de posibles alteraciones o demoras sobre éste tiempo producidas por causas externas a la empresa.

RESERVA DE LA PROPIEDAD

BENEITO FAURE se reserva el derecho a la propiedad de todos los materiales que suministre hasta que el comprador haya hecho efectivo el pago del total de los mismos.

Las mercancías pedidas se suministran bajo reserva de dominio en favor de BENEITO FAURE hasta el total cumplimiento de las obligaciones de pago del cliente.

El cliente queda obligado a cooperar y adoptar las medidas que sean necesarias y las que BENEITO FAURE le proponga para salvaguardar su propiedad sobre la mercancía. La reserva del dominio persiste incluso en el supuesto de que el cliente tuviera créditos aceptados y reconocidos contra BENEITO FAURE o se hubiera establecido un sistema de cuentas corrientes entre ambos. La transformación o mejora de la mercancía sobre la que BENEITO FAURE tiene reserva de dominio no otorga su propiedad al cliente o manipulador. En el supuesto de unión, transformación y/o cesión de los productos bajo la reserva de dominio a productos de terceros subsistirá la reserva de dominio en la proporción correspondiente al valor que tuvieran los productos objeto de reserva de dominio con anterioridad a la cesión. El cliente podrá vender los bienes sujetos a la reserva de dominio en el curso ordinario de sus negocios, siempre y cuando no haya incumplido sus obligaciones de pago frente a BENEITO FAURE. En todo caso al producirse una reventa de mercancías sujetas a reserva de dominio, se produce automáticamente la cesión a BENEITO FAURE de los créditos nacidos en consecuencia de dicha reventa en favor del vendedor, así como de cualesquiera otros créditos precedentes, en su caso de indemnizaciones por pérdida de la cosa, responsabilidad extracontractual, etc. El cliente estará obligado en estos supuestos a facilitar a BENEITO FAURE toda la información y documentación necesaria para la reclamación de los créditos subrogados. En caso de incumplimiento por parte del cliente, y en particular, en el supuesto de retraso en los pagos o en caso de declaración de concurso del cliente, BENEITO FAURE reclamará, previa notificación al cliente, en posesión de las mercancías, estando obligado éste a entregárselas. Si antes de efectuado el total pago del precio, las mercancías vendidas fuesen objeto de cualquier embargo o traba, el cliente vendrá obligado a hacer constar expresamente en la diligencia del embargo, que las mercancías son prioridad de BENEITO FAURE y si, a pesar de esta manifestación, fuesen embargados, facilitará el ejercicio por parte de la BENEITO FAURE de la correspondiente acción de tercería de dominio, cuyos gastos correrán por parte del cliente.

PLAZO DE ENTREGA

Los plazos y disponibilidad ofrecidos por BENEITO FAURE son siempre aproximados y pueden estar sujetos a variaciones. Éstas posibles variaciones en los plazos no supondrán la aceptación de la responsabilidad o penalizaciones por la demora por parte de BENEITO FAURE.

RECLAMACIONES

En el albarán del transportista deberá constar cualquier anomalía visible y, tras haber revisado el material, comunicar por escrito a nuestras oficinas la incidencia en las 24 horas siguientes a la recepción de la mercancía.

Superado este tiempo, la empresa no podrá hacerse cargo de la reclamación por no estar en el plazo por la agencia de transporte.

Para otro tipo de reclamaciones, deberá comunicarse por escrito a nuestras oficinas.

El producto que no funcione correctamente será repuesto por otro igual o que cumpla con las mismas características. En ningún caso nos haremos cargo de los costes de la mano de obra que se pueda originar por el mal funcionamiento de un producto de nuestro catálogo.

GARANTÍA

BENEITO FAURE garantiza que los productos que se venden se encuentran en perfecto estado. La garantía cubrirá la reparación o la reposición del producto (bajo decisión de BENEITO FAURE) y será necesario el previo envío de la incidencia por email. La garantía del producto se encuentra en el embalaje del mismo. El departamento técnico de BENEITO FAURE será el único autorizado para determinar si se trata de un defecto de fabricación, después de recibir por escrito la incidencia y la factura de venta para previa verificación. BENEITO FAURE basa el tiempo de garantía en los años desde que el producto fue comprado por el cliente, no en las horas de funcionamiento de éste.

La GARANTÍA no se cubrirá:

1. Si el producto ha sido previamente manipulado.
2. No se encuentra instalado según las instrucciones.
3. Si la ventilación del cuál no es la adecuada.
4. Problemas de pago parcial o en su totalidad por parte del cliente.

JURISDICCIÓN

En cualquier discrepancia o disputa, ambas partes se someterán a la jurisdicción de los Jueces y tribunales de Barcelona.

Numerical Index (Code - Page)

| | | | | | | | |
|---------|-----|---------|-----|---------|-----|---------|-----|
| 3364 | 205 | 3490 | 543 | 3624-V2 | 205 | 3909 | 576 |
| 3365 | 205 | 3491 | 543 | 3625 | 205 | 3910 | 576 |
| 3366 | 205 | 3492-N | 544 | 3654-N | 545 | 3911 | 577 |
| 3367 | 205 | 3493-N | 544 | 3655-N | 545 | 3912 | 577 |
| 3368 | 205 | 3494-N | 544 | 3656-N | 545 | 3913 | 575 |
| 3369 | 205 | 3496 | 511 | 3747 | 421 | 3914 | 575 |
| 3370 | 205 | 3497 | 511 | 3748 | 421 | 3915 | 575 |
| 3371-V2 | 205 | 3518 | 563 | 3749 | 421 | 3916-N | 367 |
| 3372 | 205 | 3519 | 563 | 3750 | 421 | 3917 | 576 |
| 3373 | 205 | 3520 | 563 | 3751 | 419 | 3918 | 576 |
| 3432-N | 544 | 3521 | 563 | 3752 | 419 | 3919 | 577 |
| 3433-N | 544 | 3522 | 563 | 3753 | 419 | 3920 | 577 |
| 3434-N | 544 | 3523 | 563 | 3754 | 419 | 3921 | 577 |
| 3435-N | 544 | 3524 | 562 | 3757 | 433 | 3922 | 577 |
| 3436-N | 544 | 3525 | 562 | 3758 | 433 | 3923 | 577 |
| 3437-N | 544 | 3526 | 562 | 3795 | 205 | 3924 | 577 |
| 3438 | 543 | 3527 | 561 | 3796 | 205 | 3925 | 575 |
| 3444 | 548 | 3528 | 561 | 3797 | 205 | 3926 | 575 |
| 3445 | 548 | 3529 | 561 | 3805 | 207 | 3927 | 575 |
| 3446 | 548 | 3530 | 561 | 3851 | 207 | 3929 | 469 |
| 3447 | 548 | 3531 | 504 | 3852 | 207 | 3931 | 469 |
| 3448 | 548 | 3532 | 504 | 3854 | 570 | 3942 | 243 |
| 3449 | 548 | 3534 | 564 | 3855 | 570 | 3943 | 243 |
| 3450 | 552 | 3537(N) | 558 | 3856 | 570 | 3944 | 243 |
| 3452 | 541 | 3538(N) | 558 | 3857 | 570 | 3945 | 243 |
| 3453 | 541 | 3539(N) | 559 | 3858 | 570 | 3948 | 383 |
| 3454 | 541 | 3569 | 542 | 3859 | 570 | 3949 | 383 |
| 3455 | 541 | 3570 | 555 | 3860 | 570 | 3950 | 383 |
| 3456 | 541 | 3571 | 555 | 3861 | 570 | 3951 | 383 |
| 3457 | 541 | 3579 | 568 | 3880 | 562 | 3952 | 383 |
| 3458 | 205 | 3580 | 477 | 3881 | 562 | 3953 | 383 |
| 3459 | 205 | 3581 | 475 | 3882 | 503 | 3955 | 491 |
| 3464 | 541 | 3582 | 424 | 3883 | 503 | 3956 | 491 |
| 3465 | 541 | 3583 | 424 | 3884 | 503 | 3957 | 491 |
| 3466 | 541 | 3584 | 424 | 3885 | 503 | 3958 | 351 |
| 3467 | 540 | 3585 | 424 | 3886 | 426 | 3959 | 351 |
| 3468 | 540 | 3586 | 419 | 3887 | 426 | 3965 | 573 |
| 3469 | 540 | 3587 | 507 | 3888 | 426 | 3972 | 399 |
| 3470 | 540 | 3589 | 433 | 3889 | 426 | 3983 | 439 |
| 3473 | 547 | 3590 | 419 | 3890 | 422 | 3984 | 439 |
| 3474-M | 552 | 3592 | 507 | 3891 | 422 | 3985 | 439 |
| 3477 | 557 | 3593 | 433 | 3892 | 422 | 3986 | 439 |
| 3478 | 557 | 3614 | 205 | 3893 | 422 | 3987 | 439 |
| 3479(N) | 560 | 3615 | 205 | 3897 | 207 | 3988 | 439 |
| 3480(N) | 560 | 3616 | 205 | 3898 | 207 | 3989-V3 | 198 |
| 3481(N) | 560 | 3617 | 205 | 3900 | 573 | 3990-V3 | 198 |
| 3482(N) | 560 | 3618 | 205 | 3901 | 573 | 3995 | 457 |
| 3483(N) | 560 | 3619 | 205 | 3902 | 573 | 3996 | 457 |
| 3484(N) | 560 | 3620 | 205 | 3903 | 573 | 3997 | 457 |
| 3485 | 381 | 3621 | 205 | 3904 | 557 | 3998 | 457 |
| 3486 | 381 | 3622 | 205 | 3905 | 557 | 3999 | 459 |
| 3489 | 543 | 3623 | 205 | 3906 | 557 | 4000 | 459 |

| | | | | | | | |
|---------|-----|--------|-----|--------|-----|---------|-----|
| 4001 | 459 | 4218 | 225 | 4332-N | 324 | 4445 | 191 |
| 4002 | 459 | 4227 | 546 | 4333 | 324 | 4447 | 191 |
| 4003 | 565 | 4228 | 546 | 4333-N | 324 | 4448 | 191 |
| 4015-V2 | 546 | 4229 | 546 | 4334 | 328 | 4449-V2 | 185 |
| 4016-V2 | 546 | 4230-N | 323 | 4334-N | 328 | 4450-V2 | 185 |
| 4017-V2 | 546 | 4231-N | 323 | 4335 | 328 | 4451 | 228 |
| 4018-V2 | 546 | 4232-N | 327 | 4335-N | 328 | 4452 | 228 |
| 4019-V2 | 546 | 4233-N | 327 | 4336-N | 191 | 4453 | 228 |
| 4020-V2 | 546 | 4236 | 375 | 4337 | 191 | 4454 | 228 |
| 4021-V2 | 546 | 4241-N | 209 | 4338-N | 191 | 4455 | 228 |
| 4022-V2 | 546 | 4242-N | 209 | 4339 | 191 | 4456 | 228 |
| 4023 | 545 | 4243 | 558 | 4340 | 481 | 4457 | 233 |
| 4024 | 545 | 4244 | 558 | 4341 | 481 | 4458 | 233 |
| 4025 | 545 | 4245 | 558 | 4349 | 486 | 4459 | 233 |
| 4028 | 572 | 4246 | 558 | 4350 | 486 | 4460 | 233 |
| 4038 | 195 | 4247 | 558 | 4351 | 486 | 4461 | 308 |
| 4039 | 195 | 4248 | 558 | 4352 | 486 | 4462 | 308 |
| 4040 | 195 | 4249 | 558 | 4353 | 486 | 4463 | 308 |
| 4049 | 200 | 4250 | 558 | 4354 | 486 | 4464 | 308 |
| 4050 | 200 | 4251 | 429 | 4355 | 486 | 4465 | 310 |
| 4096 | 211 | 4254 | 490 | 4356 | 486 | 4466 | 310 |
| 4097 | 211 | 4257 | 490 | 4362 | 205 | 4467 | 310 |
| 4098 | 211 | 4263 | 490 | 4363 | 205 | 4468 | 310 |
| 4099 | 211 | 4266 | 490 | 4364 | 205 | 4476 | 523 |
| 4106 | 360 | 4276 | 490 | 4365 | 205 | 4477 | 523 |
| 4107 | 360 | 4279 | 490 | 4367 | 453 | 4478 | 521 |
| 4108 | 359 | 4280 | 490 | 4368 | 453 | 4479 | 521 |
| 4109 | 359 | 4290 | 431 | 4369 | 452 | 4480 | 521 |
| 4111 | 360 | 4291 | 467 | 4383 | 345 | 4481 | 521 |
| 4112 | 360 | 4292 | 467 | 4384 | 345 | 4482 | 523 |
| 4113 | 360 | 4295 | 543 | 4385 | 345 | 4483 | 523 |
| 4126 | 359 | 4296 | 543 | 4386 | 345 | 4484 | 519 |
| 4127 | 359 | 4297 | 228 | 4387 | 345 | 4485 | 519 |
| 4134 | 479 | 4298 | 228 | 4388 | 345 | 4486 | 519 |
| 4135 | 429 | 4299 | 228 | 4401 | 490 | 4487 | 519 |
| 4137 | 567 | 4300 | 228 | 4402 | 490 | 4499-V2 | 372 |
| 4142-V2 | 353 | 4301 | 228 | 4410 | 230 | 4500-V2 | 371 |
| 4143-V2 | 353 | 4302 | 228 | 4411 | 230 | 4502 | 388 |
| 4174 | 347 | 4303 | 439 | 4412 | 230 | 4503 | 388 |
| 4175 | 347 | 4304 | 439 | 4413 | 230 | 4504 | 388 |
| 4176 | 195 | 4305 | 543 | 4427 | 193 | 4505 | 388 |
| 4177 | 195 | 4306 | 543 | 4428 | 193 | 4506 | 389 |
| 4178 | 195 | 4307 | 543 | 4429 | 193 | 4507 | 389 |
| 4193 | 513 | 4308 | 486 | 4430 | 193 | 4508 | 389 |
| 4194 | 513 | 4309 | 486 | 4433 | 202 | 4509 | 495 |
| 4198 | 225 | 4310 | 486 | 4435 | 202 | 4510 | 495 |
| 4199 | 225 | 4311 | 486 | 4437 | 197 | 4511 | 495 |
| 4200 | 225 | 4312 | 439 | 4438 | 197 | 4512 | 495 |
| 4201 | 225 | 4313 | 462 | 4439 | 187 | 4513 | 493 |
| 4202 | 225 | 4314 | 462 | 4440 | 187 | 4514 | 493 |
| 4203 | 225 | 4315 | 462 | 4441-N | 189 | 4515 | 493 |
| 4209 | 513 | 4331 | 452 | 4442-N | 189 | 4516 | 493 |
| 4217 | 225 | 4332 | 324 | 4444 | 191 | 4517 | 493 |

| | | | | | | | |
|------|-----|------|-----|--------|-----|------|-----|
| 4518 | 493 | 4609 | 299 | 4663 | 271 | 4750 | 307 |
| 4519 | 493 | 4610 | 299 | 4664 | 271 | 4751 | 307 |
| 4520 | 493 | 4611 | 299 | 4665 | 271 | 4752 | 307 |
| 4521 | 493 | 4612 | 299 | 4666 | 271 | 4753 | 207 |
| 4522 | 331 | 4613 | 299 | 4667 | 449 | 4754 | 207 |
| 4523 | 331 | 4614 | 299 | 4668 | 449 | 4755 | 525 |
| 4541 | 193 | 4615 | 299 | 4669 | 451 | 4756 | 525 |
| 4542 | 193 | 4616 | 299 | 4670 | 451 | 4757 | 525 |
| 4543 | 193 | 4617 | 299 | 4671 | 547 | 4758 | 527 |
| 4544 | 193 | 4618 | 299 | 4672 | 547 | 4759 | 527 |
| 4546 | 461 | 4619 | 299 | 4677 | 563 | 4761 | 220 |
| 4547 | 461 | 4620 | 299 | 4678 | 563 | 4762 | 220 |
| 4548 | 461 | 4621 | 302 | 4679 | 483 | 4763 | 220 |
| 4549 | 240 | 4622 | 302 | 4680 | 483 | 4766 | 375 |
| 4550 | 240 | 4623 | 302 | 4681 | 483 | 4767 | 376 |
| 4551 | 240 | 4624 | 302 | 4682 | 483 | 4768 | 257 |
| 4552 | 240 | 4625 | 302 | 4683 | 483 | 4769 | 257 |
| 4573 | 259 | 4626 | 302 | 4684 | 483 | 4770 | 257 |
| 4574 | 259 | 4627 | 302 | 4685 | 484 | 4771 | 257 |
| 4575 | 259 | 4628 | 302 | 4686 | 484 | 4772 | 253 |
| 4576 | 259 | 4629 | 302 | 4687 | 484 | 4773 | 253 |
| 4577 | 259 | 4630 | 302 | 4688 | 484 | 4774 | 253 |
| 4578 | 259 | 4631 | 302 | 4689 | 484 | 4775 | 253 |
| 4579 | 259 | 4632 | 302 | 4690 | 479 | 4776 | 249 |
| 4580 | 259 | 4633 | 302 | 4691 | 376 | 4777 | 249 |
| 4581 | 259 | 4634 | 302 | 4692 | 479 | 4778 | 249 |
| 4582 | 259 | 4635 | 302 | 4693 | 479 | 4779 | 249 |
| 4583 | 259 | 4636 | 302 | 4694 | 484 | 4780 | 249 |
| 4584 | 259 | 4637 | 271 | 4700 | 205 | 4781 | 249 |
| 4585 | 259 | 4638 | 271 | 4701 | 205 | 4782 | 249 |
| 4586 | 259 | 4639 | 271 | 4709 | 419 | 4783 | 249 |
| 4587 | 259 | 4640 | 271 | 4710 | 419 | 4784 | 251 |
| 4588 | 259 | 4641 | 271 | 4725-N | 365 | 4785 | 251 |
| 4589 | 300 | 4642 | 271 | 4731 | 213 | 4786 | 251 |
| 4590 | 300 | 4643 | 271 | 4732 | 213 | 4787 | 261 |
| 4591 | 300 | 4644 | 271 | 4733 | 213 | 4788 | 261 |
| 4592 | 300 | 4645 | 271 | 4734 | 213 | 4789 | 261 |
| 4593 | 300 | 4646 | 271 | 4735 | 214 | 4790 | 261 |
| 4594 | 300 | 4647 | 271 | 4736 | 214 | 4791 | 261 |
| 4595 | 300 | 4648 | 271 | 4737 | 214 | 4792 | 261 |
| 4596 | 300 | 4649 | 271 | 4738 | 214 | 4793 | 261 |
| 4597 | 300 | 4650 | 271 | 4739 | 365 | 4794 | 261 |
| 4598 | 300 | 4651 | 271 | 4739-N | 365 | 4795 | 265 |
| 4599 | 300 | 4652 | 271 | 4740 | 365 | 4796 | 265 |
| 4600 | 300 | 4653 | 271 | 4740-N | 365 | 4797 | 265 |
| 4601 | 300 | 4654 | 271 | 4742 | 217 | 4798 | 265 |
| 4602 | 300 | 4655 | 271 | 4743 | 218 | 4799 | 305 |
| 4603 | 300 | 4657 | 271 | 4744 | 217 | 4800 | 305 |
| 4604 | 300 | 4658 | 271 | 4745 | 218 | 4801 | 305 |
| 4605 | 299 | 4659 | 271 | 4746 | 217 | 4802 | 305 |
| 4606 | 299 | 4660 | 271 | 4747 | 218 | 4803 | 305 |
| 4607 | 299 | 4661 | 271 | 4748 | 217 | 4804 | 305 |
| 4608 | 299 | 4662 | 271 | 4749 | 218 | 4805 | 305 |

| | | | | | | | |
|------|-----|------|-----|------|-----|------|-----|
| 4806 | 305 | 4876 | 409 | 4935 | 220 | 5001 | 335 |
| 4807 | 271 | 4877 | 409 | 4946 | 179 | 5002 | 335 |
| 4808 | 313 | 4878 | 409 | 4947 | 179 | 5003 | 335 |
| 4809 | 313 | 4879 | 409 | 4950 | 179 | 5004 | 497 |
| 4810 | 313 | 4880 | 409 | 4951 | 179 | 5005 | 497 |
| 4811 | 313 | 4881 | 409 | 4952 | 308 | 5006 | 338 |
| 4812 | 313 | 4882 | 410 | 4953 | 308 | 5007 | 338 |
| 4813 | 313 | 4883 | 410 | 4954 | 310 | 5008 | 338 |
| 4814 | 313 | 4884 | 410 | 4955 | 310 | 5009 | 338 |
| 4815 | 313 | 4885 | 411 | 4956 | 8 | 5010 | 338 |
| 4816 | 313 | 4886 | 411 | 4957 | 445 | 5011 | 338 |
| 4817 | 313 | 4887 | 411 | 4958 | 445 | 5012 | 340 |
| 4818 | 313 | 4888 | 410 | 4959 | 445 | 5013 | 340 |
| 4819 | 313 | 4889 | 410 | 4960 | 445 | 5014 | 340 |
| 4820 | 471 | 4890 | 410 | 4961 | 445 | 5015 | 340 |
| 4821 | 220 | 4891 | 411 | 4962 | 445 | 5016 | 340 |
| 4822 | 220 | 4892 | 411 | 4963 | 207 | 5017 | 340 |
| 4823 | 220 | 4893 | 411 | 4964 | 207 | 5018 | 379 |
| 4824 | 220 | 4894 | 473 | 4965 | 207 | 5019 | 381 |
| 4825 | 220 | 4895 | 473 | 4966 | 207 | 5020 | 461 |
| 4826 | 220 | 4897 | 473 | 4967 | 207 | 5021 | 461 |
| 4827 | 449 | 4898 | 473 | 4968 | 207 | 5022 | 461 |
| 4828 | 449 | 4900 | 183 | 4969 | 207 | 5023 | 462 |
| 4829 | 451 | 4901 | 183 | 4970 | 207 | 5024 | 462 |
| 4830 | 451 | 4902 | 321 | 4971 | 207 | 5025 | 462 |
| 4831 | 372 | 4903 | 321 | 4972 | 207 | 5027 | 355 |
| 4832 | 371 | 4904 | 321 | 4973 | 207 | 5028 | 465 |
| 4833 | 197 | 4905 | 321 | 4974 | 207 | 5029 | 357 |
| 4834 | 197 | 4906 | 439 | 4975 | 207 | 5030 | 375 |
| 4837 | 403 | 4907 | 439 | 4976 | 207 | 5034 | 222 |
| 4838 | 403 | 4908 | 439 | 4977 | 207 | 5035 | 222 |
| 4839 | 403 | 4909 | 439 | 4978 | 207 | 5036 | 222 |
| 4840 | 403 | 4910 | 439 | 4979 | 363 | 5037 | 269 |
| 4841 | 403 | 4911 | 439 | 4981 | 363 | 5038 | 269 |
| 4842 | 403 | 4912 | 439 | 4982 | 445 | 5039 | 269 |
| 4843 | 403 | 4913 | 439 | 4983 | 445 | 5040 | 269 |
| 4844 | 403 | 4914 | 439 | 4984 | 445 | 5041 | 315 |
| 4845 | 403 | 4915 | 392 | 4985 | 189 | 5042 | 315 |
| 4846 | 403 | 4916 | 392 | 4986 | 189 | 5043 | 315 |
| 4847 | 403 | 4917 | 392 | 4987 | 375 | 5044 | 315 |
| 4848 | 403 | 4918 | 392 | 4988 | 375 | 5045 | 316 |
| 4849 | 407 | 4919 | 393 | 4989 | 435 | 5046 | 316 |
| 4850 | 407 | 4920 | 393 | 4990 | 435 | 5047 | 316 |
| 4851 | 407 | 4921 | 393 | 4991 | 435 | 5048 | 316 |
| 4852 | 407 | 4922 | 479 | 4992 | 435 | 5049 | 318 |
| 4853 | 407 | 4923 | 475 | 4993 | 435 | 5050 | 318 |
| 4854 | 407 | 4924 | 477 | 4994 | 435 | 5051 | 318 |
| 4855 | 407 | 4925 | 365 | 4995 | 335 | 5052 | 318 |
| 4856 | 407 | 4930 | 307 | 4996 | 335 | 5053 | 319 |
| 4857 | 407 | 4931 | 307 | 4997 | 335 | 5054 | 319 |
| 4858 | 407 | 4932 | 307 | 4998 | 335 | 5055 | 319 |
| 4859 | 407 | 4933 | 519 | 4999 | 335 | 5056 | 319 |
| 4860 | 407 | 4934 | 519 | 5000 | 335 | 5057 | 225 |

| | | | | | | | |
|------|-----|-------|-----|-------|-----|-------|-----|
| 5058 | 225 | 5137 | 321 | 25307 | 164 | 49600 | 135 |
| 5059 | 226 | 5138 | 321 | 25367 | 164 | 50460 | 148 |
| 5060 | 226 | 10119 | 105 | 25407 | 164 | 51270 | 134 |
| 5061 | 236 | 10121 | 105 | 25467 | 164 | 51277 | 134 |
| 5062 | 236 | 10122 | 105 | 27119 | 115 | 51300 | 134 |
| 5063 | 237 | 11119 | 109 | 27121 | 115 | 51307 | 134 |
| 5064 | 237 | 12119 | 108 | 27122 | 115 | 51400 | 134 |
| 5065 | 237 | 13113 | 110 | 28119 | 121 | 51407 | 134 |
| 5066 | 237 | 14119 | 111 | 29119 | 117 | 51600 | 134 |
| 5067 | 237 | 15119 | 103 | 30129 | 118 | 51607 | 134 |
| 5068 | 237 | 15121 | 103 | 30209 | 118 | 52270 | 143 |
| 5069 | 323 | 15122 | 103 | 31270 | 136 | 52277 | 143 |
| 5070 | 323 | 16119 | 102 | 31277 | 136 | 52300 | 143 |
| 5071 | 327 | 16121 | 102 | 31300 | 136 | 52307 | 143 |
| 5072 | 327 | 16122 | 102 | 31307 | 136 | 52400 | 143 |
| 5073 | 415 | 17119 | 101 | 31400 | 136 | 52407 | 143 |
| 5074 | 415 | 17121 | 101 | 31407 | 136 | 52600 | 143 |
| 5075 | 416 | 17122 | 101 | 32122 | 120 | 52607 | 143 |
| 5076 | 416 | 18119 | 100 | 33119 | 119 | 53119 | 113 |
| 5078 | 440 | 18121 | 100 | 33121 | 119 | 53121 | 113 |
| 5079 | 440 | 18122 | 100 | 33122 | 119 | 53122 | 113 |
| 5080 | 440 | 19119 | 104 | 35119 | 106 | 55270 | 145 |
| 5081 | 440 | 19121 | 104 | 35121 | 106 | 55300 | 145 |
| 5082 | 440 | 19122 | 104 | 35122 | 106 | 55400 | 145 |
| 5083 | 440 | 21119 | 114 | 36360 | 146 | 56270 | 144 |
| 5084 | 281 | 21121 | 114 | 37121 | 122 | 56300 | 144 |
| 5085 | 281 | 22119 | 116 | 38119 | 107 | 56360 | 144 |
| 5086 | 282 | 22122 | 116 | 38121 | 107 | 56400 | 144 |
| 5087 | 282 | 22410 | 170 | 38122 | 107 | 57241 | 167 |
| 5088 | 294 | 22415 | 170 | 41270 | 139 | 57242 | 167 |
| 5089 | 294 | 22420 | 170 | 41275 | 139 | 57588 | 167 |
| 5090 | 295 | 22424 | 170 | 41300 | 139 | 59249 | 167 |
| 5091 | 295 | 22430 | 170 | 41305 | 139 | 59739 | 167 |
| 5092 | 285 | 22432 | 170 | 41400 | 139 | 59769 | 167 |
| 5093 | 285 | 22435 | 170 | 41405 | 139 | 59789 | 167 |
| 5094 | 286 | 22460 | 170 | 41600 | 139 | 61270 | 141 |
| 5095 | 286 | 22490 | 168 | 41605 | 139 | 61275 | 141 |
| 5096 | 290 | 22499 | 168 | 42360 | 147 | 61300 | 141 |
| 5097 | 290 | 22726 | 168 | 42365 | 147 | 61305 | 141 |
| 5098 | 291 | 22821 | 167 | 43430 | 151 | 61400 | 141 |
| 5099 | 291 | 22856 | 167 | 44110 | 137 | 61405 | 141 |
| 5108 | 236 | 22948 | 168 | 44270 | 137 | 61600 | 141 |
| 5109 | 236 | 23119 | 112 | 44370 | 137 | 61605 | 141 |
| 5110 | 226 | 23121 | 112 | 44500 | 137 | 62412 | 170 |
| 5111 | 226 | 23122 | 112 | 45220 | 155 | 62415 | 170 |
| 5112 | 415 | 24108 | 171 | 45310 | 155 | 62430 | 170 |
| 5113 | 416 | 24109 | 171 | 45520 | 155 | 62460 | 170 |
| 5130 | 307 | 24159 | 171 | 46460 | 149 | 62475 | 170 |
| 5131 | 307 | 24208 | 171 | 46465 | 149 | 66470 | 153 |
| 5132 | 308 | 24609 | 171 | 47430 | 152 | 66477 | 153 |
| 5134 | 308 | 24758 | 171 | 49270 | 135 | 69270 | 133 |
| 5135 | 310 | 25247 | 164 | 49300 | 135 | 69275 | 133 |
| 5136 | 310 | 25277 | 164 | 49400 | 135 | 69300 | 133 |

| | | | | | | | |
|-------|-----|----------------|-----|----------------|-----|-------------------|-----|
| 69305 | 133 | 91430 | 166 | 32305-N | 142 | 592563-4C2(N) | 558 |
| 69400 | 133 | 205280 | 535 | 32405-N | 142 | 592563(N)-4C(N2) | 558 |
| 69405 | 133 | 205284 | 535 | 32605-N | 142 | 592563(N)-4F(N2) | 558 |
| 69600 | 133 | 205285 | 535 | 33XXXX | 87 | 5925631-4C2(N) | 558 |
| 69605 | 133 | 206280 | 537 | 34XXXX | 54 | 5925631(N)-4C(N2) | 558 |
| 70277 | 158 | 206284 | 537 | 35XXXX | 54 | 5925631(N)-4F(N2) | 558 |
| 70307 | 158 | 206285 | 537 | 37XXXX | 85 | 592563R-C2 | 558 |
| 70407 | 158 | 222230 | 531 | 39XX1X | 89 | 592563R-C3 | 558 |
| 70437 | 158 | 222232 | 531 | 43XXX8 | 43 | 592563R-C3 | 558 |
| 72277 | 160 | 222238 | 531 | 44X9XX | 50 | 592563R-F4 | 558 |
| 72307 | 160 | 223232 | 529 | 45XXX8 | 43 | 592563R1-C2 | 558 |
| 72407 | 160 | 223233 | 529 | 46XXXX | 91 | 592563R1-C3 | 558 |
| 72437 | 160 | 12XXXX | 78 | 49XXX2 | 90 | 592563R1-F4 | 558 |
| 74277 | 161 | 130L006 | 549 | 505119DIM-C | 562 | 59XXXX | 51 |
| 74307 | 161 | 130L006-2 | 550 | 55XXXX | 48 | 61XX0X | 57 |
| 74407 | 161 | 130L006-2F | 550 | 56XXXX | 51 | 62XXXX | 61 |
| 74437 | 161 | 130L184-5 | 551 | 582L015-C3 | 554 | 63XXXX | 63 |
| 77019 | 166 | 130L184-5F | 551 | 582L015-C3B | 554 | 64XXXX | 53 |
| 79430 | 166 | 130L195-A | 551 | 582L015-F4 | 554 | 65XXXX | 53 |
| 80260 | 166 | 130L195-B | 551 | 582L015-F4B | 554 | 67XXXX | 61 |
| 81990 | 166 | 130L195-C | 550 | 582L016T40E-C3 | 553 | 68XXXX | 58 |
| 82995 | 166 | 130L195-D | 550 | 582L016T40E-F | 553 | 69XXXX | 62 |
| 83475 | 166 | 140026-C3T | 556 | 592063-G12/3 | 555 | 6XXXXX | 56 |
| 84270 | 131 | 140026-F4T | 556 | 592063-G12/4 | 555 | 71XXXX | 83 |
| 84275 | 131 | 140L0261L | 557 | 592063-TC | 555 | 75XXXX | 47 |
| 84300 | 131 | 140L026L | 557 | 592063-TF | 555 | 81XX0X | 41 |
| 84305 | 131 | 141123-TC3 | 556 | 592072-1 | 566 | 83XXXX | 35 |
| 84400 | 131 | 141123-TC3D | 556 | 5920731-(N2) | 566 | 85XXXX | 35 |
| 84405 | 131 | 141123-TF4 | 556 | 592074-C(N) | 567 | 8XXXXX | 40 |
| 84431 | 168 | 141123-TF4D | 556 | 592076-C3(N) | 567 | 93XXXX | 38 |
| 84600 | 131 | 14XXXX | 80 | 592122-FL2 | 564 | 95XXXX | 38 |
| 84605 | 131 | 15XXXX | 67 | 592122-FL2E | 564 | D-3626 | 205 |
| 85120 | 169 | 16XXXX | 68 | 592122-FL3 | 564 | D-3627 | 205 |
| 85183 | 169 | 171160P30-C | 568 | 592122-FLE3 | 564 | D-3628 | 205 |
| 85220 | 169 | 171160P38(N)-C | 568 | 592122FD1T-4C | 564 | TR10024 | 171 |
| 85263 | 169 | 17XXXX | 71 | 592122R-C3 | 564 | TR3024 | 171 |
| 85332 | 169 | 18XXXX | 76 | 592122R39-2 | 566 | TR6024 | 171 |
| 85336 | 169 | 21XXXX | 59 | 592125R-C | 561 | Z1XX0X | 72 |
| 85360 | 167 | 22XXXX | 59 | 592125R-C3 | 561 | | |
| 85460 | 167 | 23XXXX | 59 | 592125R-F | 561 | | |
| 85470 | 167 | 242337-15C3 | 381 | 592125R2-C | 561 | | |
| 85626 | 169 | 242337-15F | 381 | 592125R2-C3 | 561 | | |
| 85876 | 168 | 243113-5B | 415 | 592125R2-F | 561 | | |
| 85884 | 168 | 243113-5N | 415 | 592125S-6(N) | 559 | | |
| 85890 | 167 | 24XXX2 | 86 | 592125S-6C(N) | 559 | | |
| 85890 | 168 | 257226C | 523 | 592125S-6F(N) | 559 | | |
| 85894 | 168 | 258226C | 521 | 592125SC-2(N) | 559 | | |
| 85993 | 169 | 26XXXX | 59 | 592125SC-3(N) | 559 | | |
| 86019 | 166 | 28XXX2 | 86 | 592125SC-4(N) | 559 | | |
| 87029 | 166 | 29XXXX | 59 | 592141-C3E2 | 571 | | |
| 88460 | 166 | 300335C3 | 379 | 592141-E4C3 | 571 | | |
| 89260 | 166 | 300335F | 379 | 592165SIL-C | 569 | | |
| 90990 | 166 | 32275-N | 142 | 592165SIL-F | 569 | | |

Alphabetical Index (Name - Page)

| | | | | | |
|--------------------------|-----|--------------------------|-----|------------------------|-----|
| Adn | 549 | BOX 27 | 115 | Esférica 7W | 558 |
| Air | 379 | BOX 28 | 121 | Fade | 477 |
| Air switch | 379 | BOX 29 | 117 | Fijo | 537 |
| Alfa | 195 | BOX 30 | 118 | Filter | 85 |
| Alp | 291 | BOX 33 | 119 | FINE 25 | 164 |
| Alp 48V | 261 | BOX 35 | 106 | FINE 31 | 136 |
| Alp suspension 48V | 261 | BOX 37 | 122 | FINE 32 N | 142 |
| Aria 30W | 570 | BOX 38 | 107 | FINE 36 | 146 |
| Aria 50W | 570 | BOX 39 | 120 | FINE 41 | 139 |
| Ark recessed | 313 | BOX 53 | 113 | FINE 42 | 147 |
| Ark surface | 313 | Caddie | 475 | FINE 43 | 151 |
| Artis | 465 | Cala 10W | 554 | FINE 44 | 137 |
| Aston | 187 | Cala 9W | 554 | FINE 45 | 155 |
| Atmos 25 | 308 | Cam 110 | 419 | FINE 46 | 149 |
| Atmos 25 GU10 | 310 | Cam 60 | 419 | FINE 47 | 152 |
| Atmos 45 | 308 | Central corner connector | 271 | FINE 49 | 135 |
| Atmos 45 GU10 | 310 | Clos 16W | 409 | FINE 50 | 148 |
| Atmos slim 25 | 307 | Clos 16W base 30cm | 410 | FINE 51 | 134 |
| Atmos slim 45 | 307 | Clos 16W base 60cm | 411 | FINE 52 | 143 |
| Avant round | 519 | Clos 8W | 409 | FINE 55 | 145 |
| Avant square | 519 | Clos 8W base 30cm | 410 | FINE 56 | 144 |
| Avant surface round | 519 | Clos 8W base 60cm | 411 | FINE 61 | 141 |
| Basculante | 535 | Comet | 415 | FINE 66 | 153 |
| Bathroom | 529 | Comet switch | 415 | FINE 69 | 133 |
| Beam | 351 | Compac round | 383 | FINE 70 | 158 |
| Blis rectangular | 445 | Compac square | 383 | FINE 72 | 160 |
| Blis round | 445 | Concord | 327 | FINE 74 | 161 |
| Blis square | 445 | Concord dimmable | 327 | FINE 84 | 131 |
| Bonn | 211 | Control Basic | 166 | Fix | 471 |
| Bora 48V | 259 | Control Casambi | 167 | Flama | 564 |
| Bora 48V suspension | 259 | Control Dali Push | 168 | Flama deco transparent | 564 |
| Bora recessed 4,5W | 300 | Control Dali Push Triac | 168 | Flama dimmable | 564 |
| Bora recessed 8,5W | 300 | Control Push Triac | 168 | Flash | 89 |
| Bora surface 4,5W | 302 | Control Top | 166 | Flexible joint track | 205 |
| Bora surface 8,5W | 302 | Control Tuya | 167 | Flexible joint track | 207 |
| Bora suspension | 281 | Converse lighting | 367 | Fly | 62 |
| Bora suspension recessed | 299 | Cookie 48V | 253 | Forest | 43 |
| Bora suspension surface | 299 | Cup 45W | 571 | Gadir | 433 |
| Bora suspension XL | 282 | Dau | 67 | Globo 10W | 562 |
| BOX 10 | 105 | Dau E | 69 | Globo 15W | 563 |
| BOX 11 | 109 | Dis | 453 | Globo 16W | 563 |
| BOX 12 | 108 | Dole | 540 | Globo 22W | 563 |
| BOX 13 | 110 | Dot 48V | 257 | Globo dimmable 10W | 562 |
| BOX 14 | 111 | Dual | 51 | Grip | 86 |
| BOX 15 | 103 | Eclipse | 531 | Grow | 360 |
| BOX 16 | 102 | Egna | 507 | Hook | 545 |
| BOX 17 | 101 | End cap | 205 | Hook dimmable | 545 |
| BOX 18 | 100 | End cap | 207 | HQI tubular E27 | 555 |
| BOX 19 | 104 | End cap recessed | 271 | HQI tubular G12 | 555 |
| BOX 21 | 114 | End cap surface | 271 | HQI tubular RX7S | 555 |
| BOX 22 | 116 | Esférica 5,5W dimmable | 558 | Icon 12W | 345 |
| BOX 23 | 112 | Esférica 5W | 558 | Icon 7W | 345 |

| | | | |
|-----------------------------------|-----|--------------------------------------|-----|
| Ilo | 359 | Mac wall 120mm | 335 |
| Ina | 453 | Mac wall 180mm | 335 |
| Iris | 511 | Mac wall 250mm | 335 |
| Joint track with spacing recessed | 207 | Magnet Track recessed | 271 |
| Joint track with spacing surface | 205 | Magnet Track surface | 271 |
| Joint track without spacing | 205 | Market | 59 |
| Kom 20W | 191 | Max | 542 |
| Kom 30W | 191 | Micro globo 6W | 562 |
| Kom 40W | 191 | Mini Comet | 416 |
| Konic | 189 | Mini Concord | 328 |
| Konic dimmable | 189 | Mini Concord dimmable | 328 |
| Kora round 20W | 371 | Mini Oxo round 1 | 236 |
| Kora round 25W | 371 | Mini Oxo square 1 | 236 |
| Kora square 20W | 372 | Mini Oxo square 2 | 237 |
| Kora square 25W | 372 | Mini Oxo square 4 | 237 |
| Krion 300W | 495 | Mini Oxo square 6 | 237 |
| Krion 400W | 495 | Mini Rubyc | 324 |
| Kubo | 47 | Mini Rubyc dimmable | 324 |
| Kubo E | 48 | Mis round | 461 |
| L joint ceiling recessed | 271 | Mis round switch | 461 |
| L joint ceiling surface | 271 | Mis square | 462 |
| L Joint track recessed | 207 | Mis square switch | 462 |
| L Joint track surface | 205 | Moon | 572 |
| L joint wall ceiling recessed | 271 | Motion Sensor | 169 |
| L joint wall ceiling surface | 271 | Nano alp | 290 |
| Lao | 355 | Nano oxo round | 240 |
| Lek round | 439 | Nano oxo square | 240 |
| Lek square | 439 | Nano pulsar round | 228 |
| Lek XL round | 440 | Nano pulsar round surface accessory | 230 |
| Lek XL square | 440 | Nano pulsar square | 228 |
| Lena | 185 | Nano pulsar square surface accessory | 230 |
| Lievo | 365 | Narrow GU10 dimmable | 547 |
| Lievo suspension | 294 | Narrow MR16 | 547 |
| Lievo switch | 365 | Neo | 421 |
| Lievo XL suspension | 295 | Neo sensor | 424 |
| Line 48V 15W | 251 | Neo XL | 422 |
| Line 48V 30W | 251 | Neo XL sensor | 426 |
| Line 48V 7,5W | 251 | Nexus | 50 |
| Lineal 13W | 557 | Nik | 467 |
| Lineal 9W | 557 | Nitro | 540 |
| Lineal tubular 11W dimmable | 557 | Nix | 452 |
| Lineal tubular 5W | 556 | Noa 80W | 573 |
| Lineal tubular 9W | 556 | Noa 85W | 573 |
| Lineal tubular 9W dimmable | 556 | Noi | 381 |
| Linear joint recessed | 271 | Noi dimmable | 381 |
| Linear joint surface | 271 | Noi switch | 381 |
| Lucky | 459 | Nox | 209 |
| Luk | 527 | Obo 19W | 576 |
| Lynk G53 | 541 | Obo 27W | 576 |
| Lynk GU10 | 541 | Obo 36W | 577 |
| Lynk GU10 dimmable | 541 | Obo 45W | 577 |
| Mac 30 | 403 | One recessed | 521 |
| Mac 60 | 403 | One surface | 521 |

| | | | |
|--------------------------|-----|--------------------------|-----|
| One wall | 338 | R-80 | 567 |
| One wall dual | 338 | R-90 | 567 |
| Optic | 452 | Rok | 525 |
| Oxo round | 233 | Rubyc | 323 |
| Oxo square | 233 | Rubyc dimmable | 323 |
| Par 30 | 568 | Sair 10W | 473 |
| Par 38 | 568 | Sair 20W | 473 |
| Piccolo | 197 | Selen | 449 |
| Piccolo AR11 base | 202 | Shop | 552 |
| Piccolo AR11 track | 202 | Sigma 17W | 429 |
| Piccolo base | 197 | Sigma 3W | 429 |
| Piccolo GU10 base | 200 | Signal | 431 |
| Piccolo GU10 track | 200 | Sil | 569 |
| Piccolo GU10 track V3 | 198 | Skin | 359 |
| PL T40 | 553 | Sky 100W | 491 |
| Plus | 331 | Sky 10W | 490 |
| Polaris 100W | 493 | Sky 150W | 491 |
| Polaris 150W | 493 | Sky 200W | 491 |
| Polaris 200W | 493 | Sky 20W | 490 |
| Polo | 457 | Sky 30W | 490 |
| Popa 100 | 503 | Sky microwave sensor 10W | 486 |
| Popa 60 | 503 | Sky microwave sensor 30W | 486 |
| Port | 360 | Sky microwave sensor 50W | 486 |
| Power GU10 | 543 | Sky switch 10W | 483 |
| Power GU10 dimmable | 543 | Sky switch 20W | 483 |
| Power MR16 | 543 | Sky switch 30W | 484 |
| Power Supplies Basic | 170 | Sky switch 40W | 484 |
| Power Supplies Dali | 171 | Sky with spike | 481 |
| Power Supplies Slim | 171 | Smile 20W | 575 |
| Power Supplies Standard | 170 | Smile 40W | 575 |
| Power Supplies Top | 170 | Smile 60W | 575 |
| Power Supplies Triac | 171 | Sono 40W | 179 |
| Prisma | 552 | Sono 60W | 179 |
| Proa | 504 | Square | 87 |
| Pulcom asymmetric trim | 220 | Standard 10W dimmable | 561 |
| Pulcom led | 220 | Standard 12W | 560 |
| Pulcom round | 217 | Standard 12W dimmable | 561 |
| Pulcom round asymmetric | 218 | Standard 15W | 560 |
| Pulcom square | 217 | Standard 17W dimmable | 561 |
| Pulcom square asymmetric | 218 | Standard 6W | 559 |
| Pulcom surface accessory | 222 | Standard 9W | 559 |
| Pulcom trim | 220 | Start connector | 271 |
| Pulsar | 225 | Stem | 363 |
| Pulsar asymmetric trim | 226 | Steps | 360 |
| Pulsar surface accessory | 226 | Sunset round | 435 |
| Pulsar switch | 225 | Sunset square | 435 |
| Pun | 357 | Suspension kit | 205 |
| Pure | 353 | Suspension kit | 271 |
| PVC trim | 271 | Sweet | 347 |
| R-39 | 566 | System GU10 | 544 |
| R-50 | 566 | System GU10 dimmable | 544 |
| R-63 | 566 | System MR16 | 544 |
| R-63 s-line | 565 | T Joint track recessed | 207 |

| | | | |
|-----------------------------|-----|------------------------|-----|
| T Joint track surface | 205 | Unirform-line GU10 | 546 |
| Tao | 243 | Urban | 53 |
| Thesis 15W | 375 | Urban asymmetric | 58 |
| Thesis 15W dimmable | 376 | Urban E | 54 |
| Thesis 25W | 375 | Urban sensor | 57 |
| Thesis 25W dimmable | 376 | Urban track | 56 |
| Thesis 35W | 375 | Visor | 469 |
| Three phase adapter | 205 | Visor solar | 513 |
| Three phase recessed base | 207 | Volt round 1 | 315 |
| Three phase surface base | 205 | Volt round 1 GU10 | 318 |
| Three phase track recessed | 207 | Volt round 3 | 316 |
| Three phase track surface | 205 | Volt round 3 GU10 | 319 |
| Time | 35 | Volt round 48V | 269 |
| Time E | 38 | Volt square 1 | 315 |
| Time track | 40 | Volt square 1 GU10 | 318 |
| Time wall sensor | 41 | Volt square 3 | 316 |
| Tot 40W | 321 | Volt square 3 GU10 | 319 |
| Tot 60W | 321 | Volt square 48V | 269 |
| Track ceiling recessed | 207 | Wech | 497 |
| Track ceiling surface | 205 | Work | 63 |
| Track power supply recessed | 207 | X Joint track recessed | 207 |
| Track power supply surface | 205 | X Joint track surface | 205 |
| Train | 61 | Zas round | 479 |
| Tram 20W | 193 | Zas square | 479 |
| Tram 30W | 193 | Zero design | 72 |
| Tram 48V 4,5W | 249 | Zero direct | 71 |
| Tram 48V 9W | 249 | Zero dual | 76 |
| Tram recessed 10 | 214 | Zero in | 78 |
| Tram recessed 15 | 214 | Zero out | 80 |
| Tram recessed 2 | 213 | Zibor | 451 |
| Tram recessed 5 | 213 | Zio | 523 |
| Triton | 90 | Zio surface | 523 |
| Triton down | 91 | Zio wall | 340 |
| Tubi | 83 | Zio wall dual | 340 |
| Tura 30 | 407 | Zoe | 285 |
| Tura 60 | 407 | Zoe 48V | 265 |
| Tutto GU10 | 548 | Zoe recessed | 305 |
| Tutto MR11 | 548 | Zoe surface | 305 |
| Ufo 300W | 399 | Zoe XL | 286 |
| Ufo Lens 100W | 388 | Zoom | 183 |
| Ufo Lens 150W | 388 | | |
| Ufo Lens 200W | 389 | | |
| Ufo Lens 240W | 389 | | |
| Ufo Lens Dali 100W | 392 | | |
| Ufo Lens Dali 150W | 392 | | |
| Ufo Lens Dali 200W | 393 | | |
| Ufo Lens Dali 240W | 393 | | |
| Unidorm-line MR16 | 546 | | |
| Uniform-line G4 | 550 | | |
| Uniform-line G9 | 551 | | |
| Uniform-line GU10 dimmable | 546 | | |
| Uniform-line long G4 | 550 | | |
| Uniform-line long G9 | 551 | | |



Showroom Benito Faure, La Roca del Valles (Spain).



Headquarters

C/ Nòria 10
Polig. Valldoriolf
08430 La Roca del Vallès
Barcelona (Spain)

C/ Thomas Edison 4-6
Polig. Valldoriolf
08430 La Roca del Vallès
Barcelona (Spain)





Headquarters



Showroom Beneito Faure, La Roca del Valles (Spain).



Headquarters



Showroom Beneito Faure, La Roca del Valles (Spain).

passion for led light



BENEITO FAURE