

acquabella



acquabella.com





Iconografía



Material Akron



Corte a medida



Rejilla inox Base/Arq incluida



Tapa Akron Areia incluida



Tapa Akron Flow incluida



Rebosadero cromo incluido



Fácil acceso



Material Dolotek



Desagüe incluido
(Base / Arq / Unic / Areia / Natur / Smart / Focus)



Rejilla Akron Base/Arq incluida
(3 modelos disponibles)



Rejilla Akron Natur incluida



Rejilla Akron Focus incluida



Desagüe incluido
(Opal Quiz / Lech / Dewa / Voss / Chrea / Levi / Vars / Venet / Boreal)



Material ligero

Contenido

<i>Empresa</i>	4-9
<i>Akron</i>	10-11
<i>Texturas y colores</i>	12-17
<i>Dolotek</i>	18-19
<i>Platos de ducha</i>	20-141
<i>Bañeras</i>	142-187
<i>Paneles</i>	188-209
<i>Encimeras</i>	210-243
<i>Lavabos</i>	244-271
<i>Tótems</i>	272-285
<i>Muebles y accesorios</i>	286-323
<i>Información técnica</i>	324-344



UNE-EN 16165:2022 Anexo A
*Beton / Slate / Slate Evo / Arabba / Wave / Zero



Desagüe incluido
(Halo / Tempo / Flow)



Rejilla Akron Unic incluida
(3 modelos disponibles)



Rejilla Akron Smart incluida



Rejilla inox Prisma incluida



Desagüe incluido
(Nevis)



Stock: salida de fábrica en 48h



Espesor máximo y mínimo



Desagüe incluido
(Prisma)



Tapa Akron Halo incluida



Tapa Akron Tempo incluida



Rebosadero integrado



Patas regulables incluidas

Alta costura para tu baño

Damos vida a tus ideas con innovadoras soluciones a medida para el cuarto de baño que ayudan a crear espacios de bienestar. La innovación y la sostenibilidad nos marcan el camino, pero siempre manteniendo el foco en lo más importante: las personas y su confianza en nuestro equipo.

Nuestra esencia



Profesionalidad

Seguimos un enfoque industrial riguroso, exacto y fiable gracias a un capital humano que demuestra un profundo compromiso por su trabajo.



Calidad

Tenemos una actitud responsable con la calidad del producto y el servicio al cliente y, por ello, hemos obtenido la certificación ISO 9001.



Creatividad

La innovación es el alimento que nos nutre. Gracias a la escucha activa y la capacidad de innovación del equipo, creamos productos adaptados a las necesidades del público.



Superación

Somos capaces de mejorar cada día nuestras relaciones y nuestros productos y servicios, siempre con el objetivo de alcanzar la excelencia.



Trabajo en equipo

Trabajamos en base al respeto y la cooperación, aprovechando las perspectivas diversas y potenciando lo mejor de cada persona.

Diseñamos experiencias únicas

Somos creadores de sensaciones. A través del diseño, las texturas y los colores, elevamos la experiencia de la ducha a otro nivel. En Acquabella sostenemos una identidad propia que queda reflejada en cada uno de nuestros productos y apariciones. La perfecta combinación entre la más avanzada tecnología y los trabajos artesanales ofrece el máximo cuidado por los detalles, dando como resultado espacios adaptados a cada persona o proyecto.



Material de calidad certificada

Productos fabricados con materiales altamente resistentes y de fácil mantenimiento que aseguran su durabilidad en el tiempo.



Adaptabilidad

Damos vida a tus ideas gracias a la posibilidad del corte a medida, la amplitud de formatos y la capacidad de personalización de nuestros productos.



Biblioteca 3D

Hacemos realidad tus proyectos de la mano de la tecnología. Descubre nuestra biblioteca 3D y diseña el cuarto de baño a tu medida.





Apuesta por un desarrollo sostenible

En Acquabella somos plenamente conscientes de nuestra responsabilidad con el medio ambiente y la sociedad. Por ello, nuestra empresa reconoce como propios los Objetivos de Desarrollo Sostenible (ODS) acordados en las Naciones Unidas. En este sentido, nos comprometemos a medir nuestro impacto ambiental y a la puesta en marcha de acciones que contribuyan a un crecimiento sostenible.

Innovación para transformar el futuro

Queremos generar experiencias únicas de confort, diseño y seguridad. Buscamos avanzar de la mano de la tecnología más sostenible, con un firme compromiso por la calidad y teniendo en cuenta las necesidades de todas las personas que forman parte de nuestra empresa y del entorno. Esta convicción nos ha hecho merecedores de reconocidas certificaciones internacionales.



9001:2015
Sistema de gestión de
Calidad



14001:2015
Sistema de gestión Ambiental



45001:2018
Sistema de gestión de la
seguridad y salud en el trabajo

Escanea el código si quieres
conocer nuestras acciones de RSC.



Akron

Akron es un material de nueva generación compuesto de poliuretano y cargas minerales de alta calidad y diferente granulometría, que se compacta en masa para lograr un acabado macizo y reforzado. La superficie está tratada con un revestimiento acrílico de poliuretano que garantiza una total integración físico-química con el soporte. La avanzada fórmula del Akron nos permite crear productos con texturas en alta definición, atrevidas formas y amplia variedad de colores, cuyo resultado son productos con diseño extraordinario y altas propiedades técnicas. Además, Akron se ha desarrollado de manera eficiente y respetuosa con el medio ambiente. Un antes y un después en el mundo del baño.





Composite en base poliuretánica con cargas minerales



Resistente al choque térmico



Antideslizamiento Clase C
* *Beton / Slate / Slate Evo / Arabba / Wave / Zero*



Aislamiento acústico
(DIN 4109 / SIA181 / DIN EN ISO 717-2:2020-01)



Certificado antibacteriano
(ISO 22196:2011)



Facilidad de corte



Clase 1 en UNE-EN 14527:2016 + A1:2019



Texturas de alta definición



Resistente a la hidrólisis. 0% poliéster ortoftálico



Corte seguro. Material sin sílice



Aptitud para la limpieza



Material 25% más ligero que otros materiales similares



Resistencia química



Evaluación de emisiones de COVs de productos de interior (ISO 16000-6:2006) A+ y evaluación de CMR



Resistente a impactos



Todos los colores en todas las texturas

Texturas

Nuestras colecciones han sido concebidas para reproducir texturas de alta definición, sofisticadas y elegantes. Conseguimos transmitir con asombrosa fidelidad unos acabados inspirados en la más pura naturaleza. Además, las texturas de Acquabella son agradables al tacto, capaces de trasladarnos a un universo de sensaciones para los 5 sentidos.

Wave



Quiz

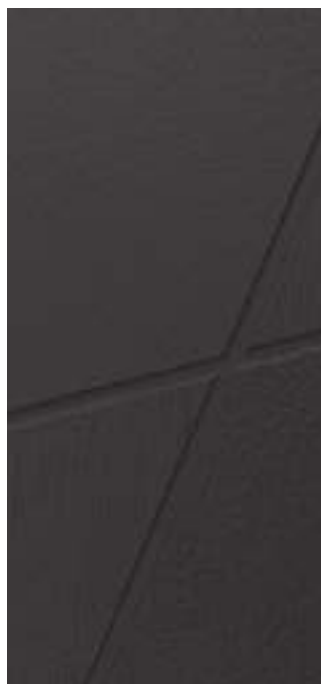

Arabba





Beton



Slate



Zero



Nude



COLORESSTANDARD



COLORESNATURALLY MADE

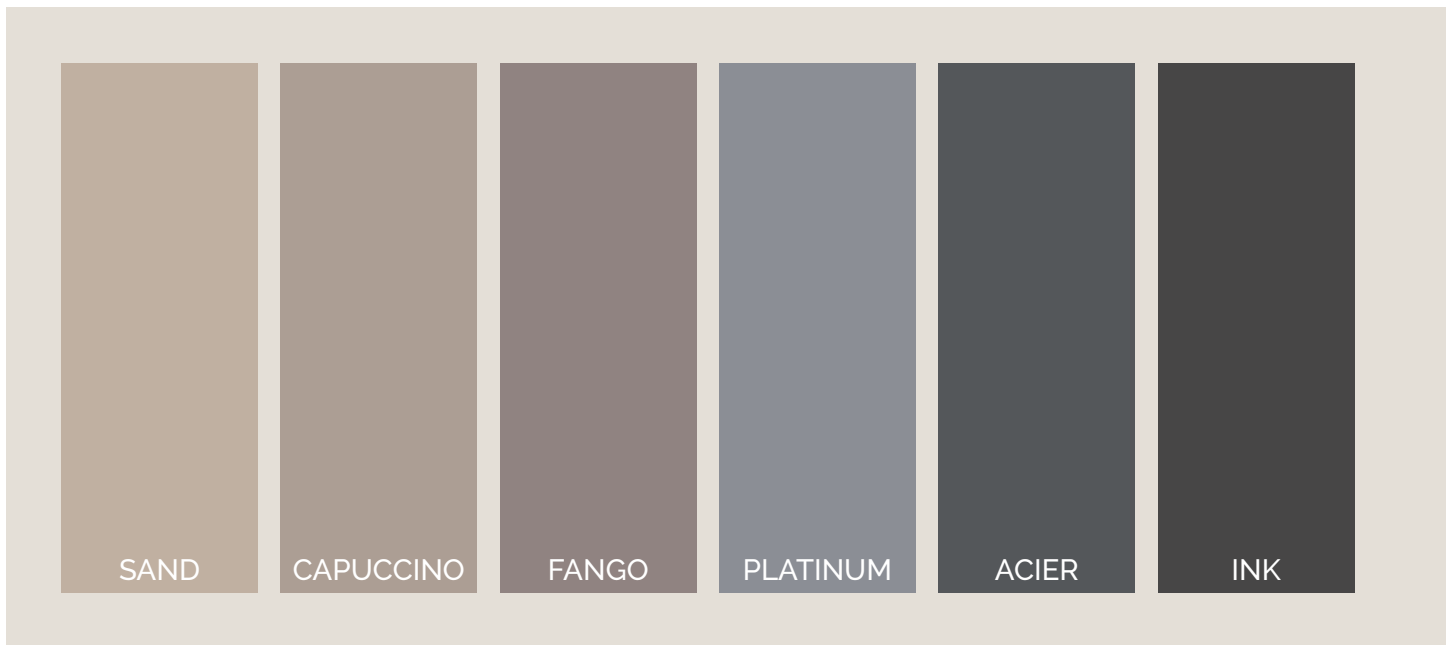

Colores

El color es nuestra forma de expresar emociones. Su uso nos permite dar rienda suelta a la creatividad y diseñar inspiradores espacios de baño. Ponemos a tu disposición 4 gamas de colores diferenciadas: los colores Standard, compuestos por tonalidades versátiles y atemporales; los colores Naturally Made, inspirados en el poder de la naturaleza; los colores Season, novedad de este año, una cuidadosa selección de los colores tendencia; y por último, la carta RAL/NCS, formada por más de 2.000 colores. Con Acquabella, tu imaginación será el límite.

COLORESRAL/NCS



NCS S 6020-B90G

NOTA: ejemplos NCS

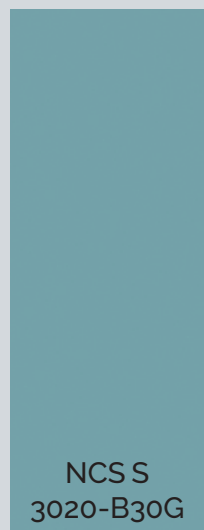

NCS S
3020-B30G

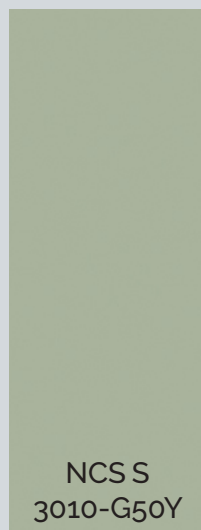

NCS S
3010-G50Y

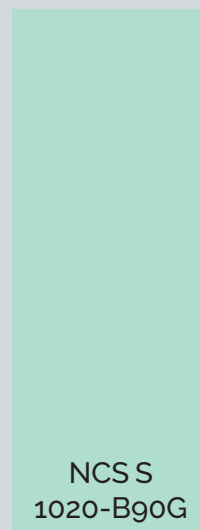

NCS S
1020-B90G

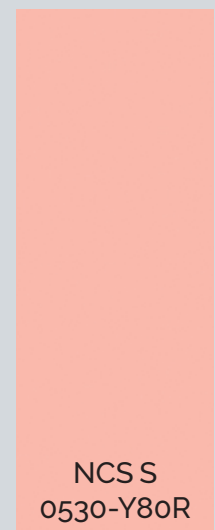

NCS S
0530-Y80R

Colores Season

Abanderados del diseño y las tendencias, hemos realizado una selección única de colores con los que llenar de frescura y estilo el cuarto de baño. Una línea cromática vibrante que, lejos de ser exagerada, transmite calma, minimalismo y elegancia. Se compone de románticos tonos pastel ligeramente empolvados. Es el momento de ampliar nuevos horizontes de la mano de los colores tendencia del año de Acquabella.





Dolotek

Gracias a la tecnología desarrollada, la roca que se formó hace millones de años, se transforma en productos modernos, duraderos y elegantes. Las características de uso de Dolotek son superiores a las de los materiales tradicionales, por lo que a menudo se denomina "cerámica del siglo XXI". Formado por una resina y piedra dolomita que da como resultado un material de tacto suave y blanco puro.

Las propiedades químicas y físicas de Dolotek permiten la fabricación de productos de alta calidad técnica y su moldeamiento en formas complejas bajo un diseño funcional, haciendo más fácil nuestro día a día. El proceso tecnológico que permite la elaboración de Dolotek, desarrollado de manera eficiente y respetuosa con el medio ambiente, no tiene igual en todo el sector del baño.





Compuesto de resina de poliéster y piedra de dolomita



Resistente al choque térmico



Recubrimiento de altas prestaciones



Aislamiento acústico



Certificado antibacteriano
(ISO 22196:2007)



Durabilidad



Aptitud para la limpieza



Versatilidad



Resistente a los UV



Tacto sedoso



Resistente al fuego



Precisión



Resistencia química



Evaluación de emisiones de COVs de productos de interior (ISO 16000-6:2006) A+ y evaluación de CMR





Platos de ducha

Nuevo concepto de rejillas 22-23

Base Slate 24-35

Base Beton 36-43

Base Zero 44-49

Base Nude 50-55

Arq Zero 56-63

Unic Slate 64-73

Halo Slate 74-83

Areia Slate Evo 84-93

Natur Wave 94-103

Smart Quiz 104-111

Tempo Arabba 112-119

Flow Zero 120-127

Focus Beton 128-135

Prisma Slate 136-141

La evolución de nuestra esencia

Con el afán de reinventarnos cada día, los modelos Base y Arq evolucionan para ofrecer nuevas opciones de personalización, llevándolos a un nivel superior de adaptabilidad. Proponemos una innovadora colección de rejillas a escoger entre Mia (disponible en acabados Akron e Inox), Geo y Lux (únicamente disponibles en Akron).



MIA INOX





MIA

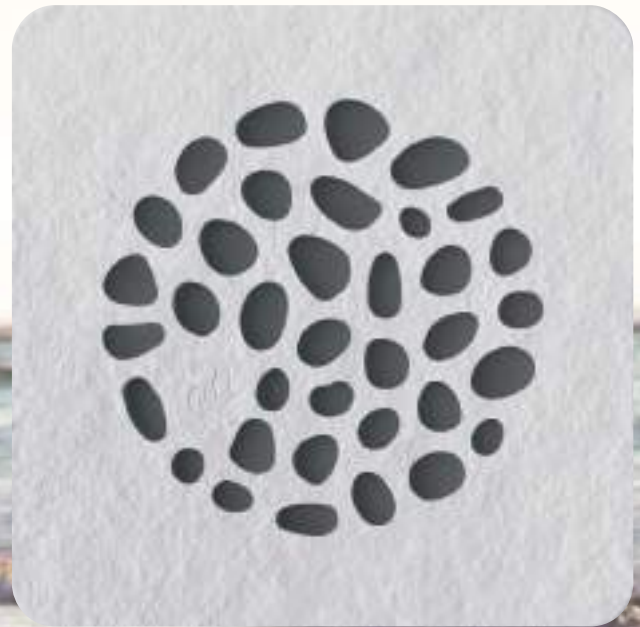

GEO

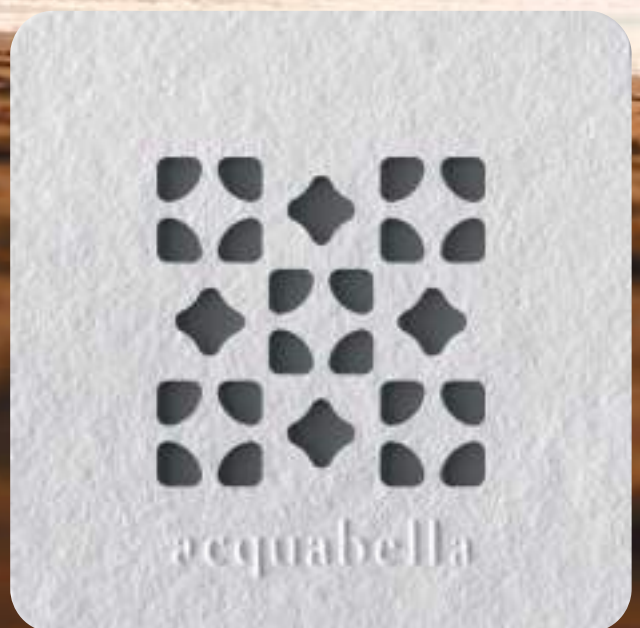

LUX



Base Slate

Convertido en un básico indispensable del cuarto de baño, el modelo Base se viste con la elegante textura Slate para llenar de funcionalidad el espacio. El plato de ducha Base Slate se adapta perfectamente a las necesidades del baño, gracias a la amplia variedad de formatos que ofrece y la posibilidad de corte a medida.



Dimensiones estándar (cm)

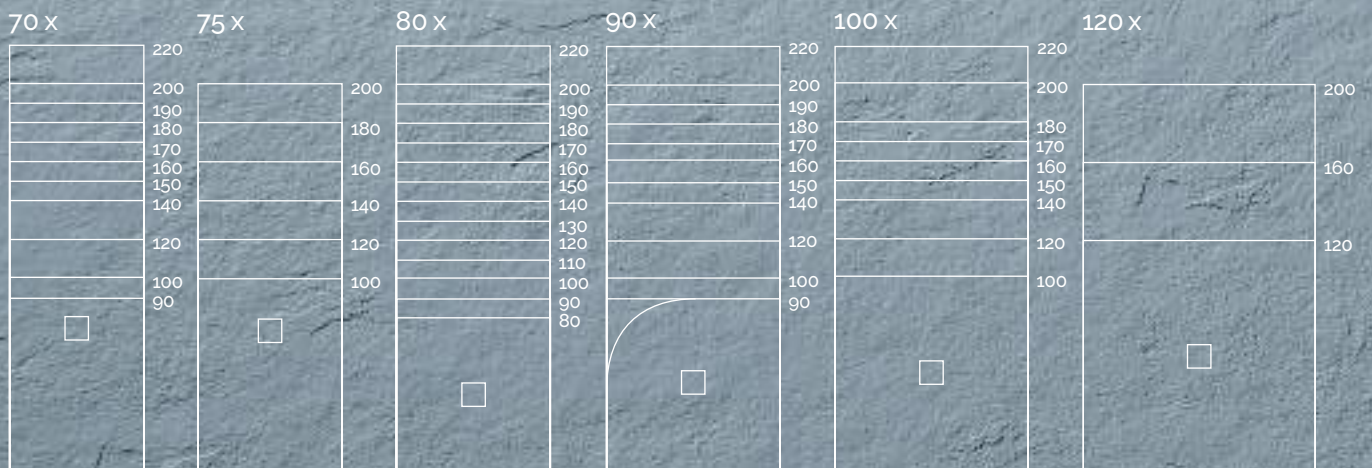

Rejillas disponibles

Mia inox



Mia



Geo

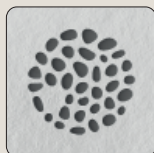

Lux











Base Slate



Base Slate blanco 150x90 cm



Colores

Standard

blanco nacar beige marfil crema

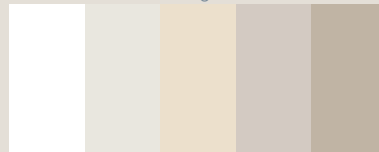

grey cemento moka lava negro



Naturally Made

sand capuccino fango platinum acier ink

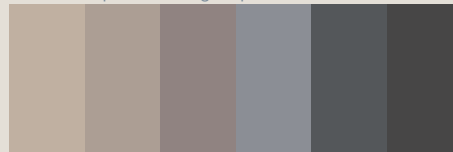

Season

burgundy petal ocean sky forest mint



RaL/NCS











BASE SLATECOMPLEMENTOS

Rejilla

		Textura	Medidas (cm)	Standard	Nat. Made	Season	RaL/NCS
	Rejilla Mia inox	-	12 x 12	✓	✓	✓	✓
	Rejilla Mia Akron	Slate	12 x 12	✓	✓	✓	✓
	Rejilla Geo Akron	Slate	12 x 12	✓	✓	✓	✓
	Rejilla Lux Akron	Slate	12 x 12	✓	✓	✓	✓

NOTA: incluido un solo modelo de rejilla por plato de ducha, a elegir entre: Mia, Geo o Lux.

Desagües (mm)

	Desagüe estándar			✓
	Desagüe vertical			✓
	Desagüe extraplano			🛒
	Desagüe gran caudal			🛒

NOTA: incluido un solo modelo de desagüe por plato de ducha.

Moldura

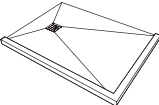
		Textura	Medidas (cm)	
	Moldura	Slate	4,1 x 5	🛒

Zona de secado

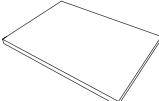
		Textura	Medidas (cm)	
	Zona de secado	Slate	100 x 100 x 2,3	🛒

Zócalo de elevación

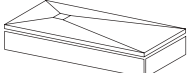
		Textura	Medidas (cm)	
	Zócalo	Slate	60 - 220 x 9 x 1,6	🛒

Materiales para la instalación



Set básico de impermeabilización

Kerdi-TS Schlüter Systems



Cola de pegado

Ultrabond MS Rapid



Silicona sellado juntas

Mapesil AC



BASE SLATE INFORMACIÓN TÉCNICA

Corte a medida

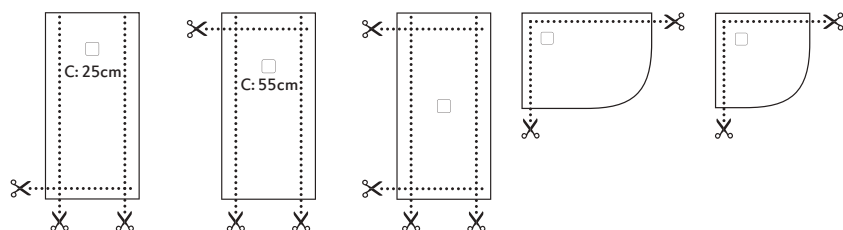

Dimensiones

	A (cm)	B (cm)	C (cm)		A (cm)	B (cm)	C (cm)
	90	70/80	25		80	80	40
	100	70/75/80/90	25		90	90	45
	110	80	25		100	100	50
	120	70/75/80/90/100	25		120	120	60
	130	80	25				
	140	70/75/80/90/100	55				
	150	70/80/90/100	55				
	160	70/75/80/90/100/120	55				
	170	70/80/90/100	55				
	180	70/75/80/90/100	55				
180	80/90/100	90					
190	70/80/90	55					
200	70/75/80/90/100/120	55					
200	80/90/100	100					
220	70/80/90/100	110					

	A (cm)	B (cm)	C (cm)
90	90	26	
90 Dx	120	27	
90 Sx	120	27	

Ensayos

Textura	Ensayo	Resultado
SLATE	UNE EN 16165:2022 Anexo A	CLASE C
	Normativa francesa XPP 05-010	PN 24

Ficha técnica de producto

Manual de instalación





Base Beton

El plato de ducha a medida Base Beton es capaz de dar un toque de frescura a cualquier cuarto de baño gracias a la textura de aspecto cemento. Su simplicidad lo convierte en un gran aliado a la hora de combinar otros elementos, mientras que su textura desenfadada conseguirá que sea el protagonista del cuarto de baño.



Dimensiones estándar (cm)

70 x

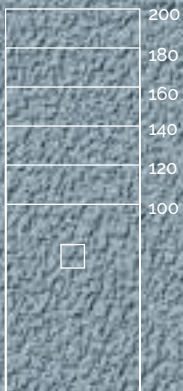

80 x

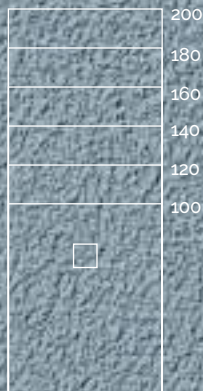

90 x

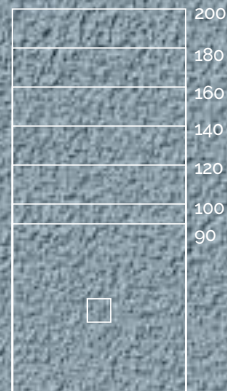

100 x

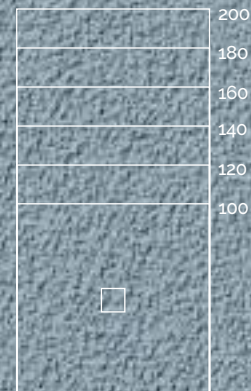

Rejillas disponibles

Mia inox



Mia

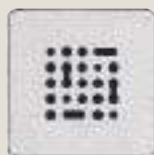

Geo



Lux







Base Beton



Base Mia Beton NCS S 3040-Y60R 200x100 cm



Colores

Standard

blanco nacar beige marfil crema

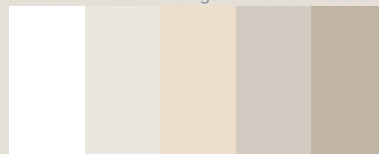

grey cemento moka lava negro



Naturally Made

sand capuccino fango platinum acier ink



Season

burgundy petal ocean sky forest mint

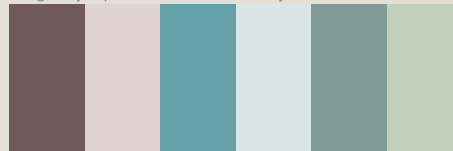





Ra/NCS



BASE BETONCOMPLEMENTOS

Rejilla

		Textura	Medidas (cm)	Standard	Nat. Made	Season	RaL/NCS
	Rejilla Mia inox	-	12 x 12	✓	✓	✓	✓
	Rejilla Mia Akron	Beton	12 x 12	✓	✓	✓	✓
	Rejilla Geo Akron	Beton	12 x 12	✓	✓	✓	✓
	Rejilla Lux Akron	Beton	12 x 12	✓	✓	✓	✓

NOTA: incluido un solo modelo de rejilla por plato de ducha, a elegir entre: Mia, Geo o Lux.

Desagües (mm)

	Desagüe estándar			✓
	Desagüe vertical			✓
	Desagüe extraplano			🛒
	Desagüe gran caudal			🛒

NOTA: incluido un solo modelo de desagüe por plato de ducha.

Moldura

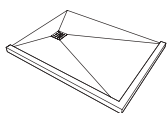
		Textura	Medidas (cm)	
	Moldura	Beton	4,1 x 5	🛒

Zócalo de elevación

		Textura	Medidas (cm)	
	Zócalo	Beton	60 - 200 x 9 x 1,6	🛒

Materiales para la instalación



Set básico de impermeabilización

Kerdi-TS Schlüter Systems



Cola de pegado

Ultrabond MS Rapid



Silicona sellado juntas

Mapesil AC



BASE BETON INFORMACIÓN TÉCNICA

Corte a medida

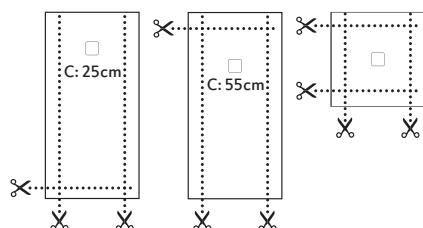

Dimensiones

	A (cm)	B (cm)	C (cm)		A (cm)	B (cm)	C (cm)
	100	70/80/90	25		90	90	45
	120	70/80/90/100	25		100	100	50
	140	70/80/90/100	55				
	160	70/80/90/100	55				
	180	70/80/90/100	55				
	200	70/80/90/100	55				

Ensayos

Textura	Ensayo	Resultado
BETON	UNE-EN 16165:2022 Anexo A	CLASE C
	Normativa francesa XP P 05-010	PN 24

Ficha técnica de producto



Manual de instalación





Base Zero

Una microtextura prácticamente lisa conforma el plato de ducha a medida Base Zero, convirtiéndolo en una pieza fundamental del diseño moderno. Su minimalismo conseguirá un interior versátil y atemporal, fundamental en hogares y hoteles. Base Zero dotará cualquier cuarto de baño de una amplitud sin igual.



Dimensiones estándar (cm)

70 x



80 x

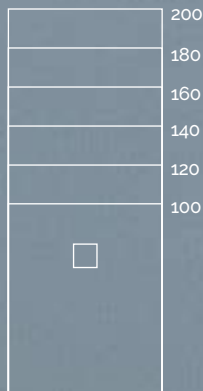

90 x

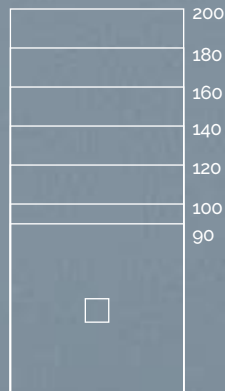

100 x

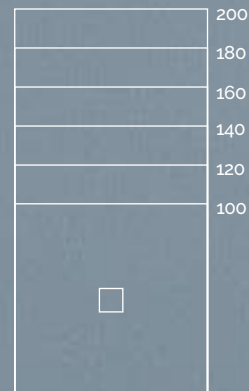

Rejillas disponibles

Mia inox



Mia



Geo



Lux



Base Zero



Base Mia Zero negro 200x100 cm



Colores

Standard

blanco nacar beige marfil crema

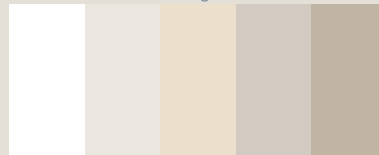

grey cemento moka lava negro

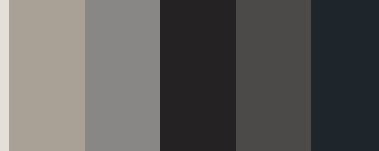

Naturally Made

sand capuccino fango platinum acier ink

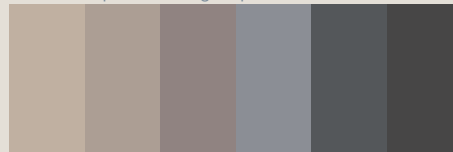

Season

burgundy petal ocean sky forest mint

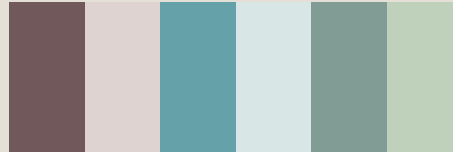

Ra/NCS



BASE ZERO COMPLEMENTOS

Rejilla

		Textura	Medidas (cm)	Standard	Nat. Made	Season	RaL/NCS
	Rejilla Mia inox	-	12 x 12	✓	✓	✓	✓
	Rejilla Mia Akron	Zero	12 x 12	✓	✓	✓	✓
	Rejilla Geo Akron	Zero	12 x 12	✓	✓	✓	✓
	Rejilla Lux Akron	Zero	12 x 12	✓	✓	✓	✓

NOTA: incluido un solo modelo de rejilla por plato de ducha, a elegir entre: Mia, Geo o Lux.

Desagües (mm)

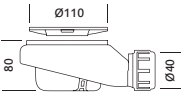
	Desagüe estándar			✓
	Desagüe vertical			✓
	Desagüe extraplano			🛒
	Desagüe gran caudal			🛒

NOTA: incluido un solo modelo de desagüe por plato de ducha.

Moldura

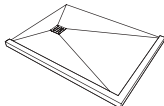
		Textura	Medidas (cm)	
	Moldura	Zero	4,1 x 5	🛒

Zócalo de elevación

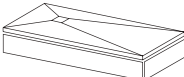
		Textura	Medidas (cm)	
	Zócalo	Zero	60 - 200 x 9 x 1,6	🛒

Materiales para la instalación



Set básico de impermeabilización

Kerdi-TS Schlüter Systems



Cola de pegado

Ultrabond MS Rapid



Silicona sellado juntas

Mapesil AC



BASE ZERO INFORMACIÓN TÉCNICA

Corte a medida

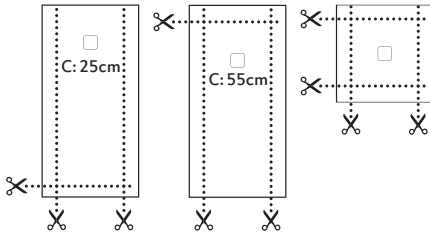

Dimensiones

A (cm)	Rectangular			A (cm)	Square		
	B (cm)	B (cm)	C (cm)		B (cm)	B (cm)	C (cm)
100	70/80/90	70/80/90	25	90	90	45	
120	70/80/90/100	70/80/90/100	25	100	100	50	
140	70/80/90/100	70/80/90/100	55				
160	70/80/90/100	70/80/90/100	55				
180	70/80/90/100	70/80/90/100	55				
200	70/80/90/100	70/80/90/100	55				

Ensayos

Textura	Ensayo	Resultado
ZERO	UNE-EN 16165:2022 Anexo A	CLASE C
	Normativa francesa XP P 05-010	PN 24

Ficha técnica de producto



Manual de instalación





Base Nude

La originalidad es el emblema del plato de ducha a medida Base Nude. La exclusiva textura en alta definición Nude reproduce a la perfección el aspecto de la piel, transmitiendo calidez al espacio. Un modelo que, gracias a la sencillez que lo caracteriza, cede el protagonismo al acabado, creando un plato de ducha elegante y rompedor.



Dimensiones estándar (cm)

80 x

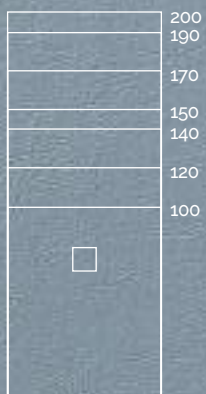

90 x

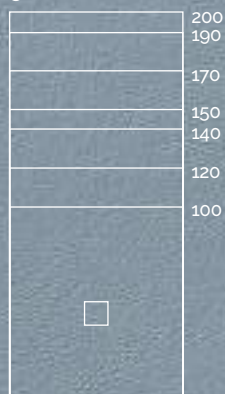

100 x

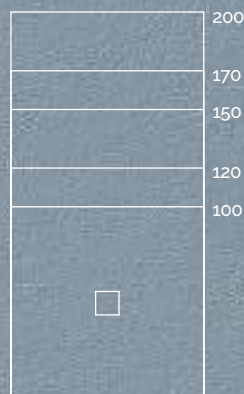

Rejillas disponibles

Mia inox



Mia



Geo



Lux



Base Nude



Base Geo Nude crema 170x90 cm



Colores

Standard

blanco nacar beige marfil crema

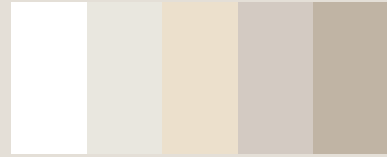

grey cemento moka lava negro

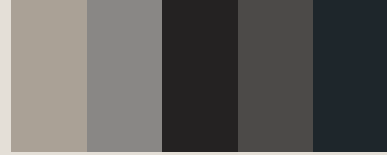

Naturally Made

sand capuccino fango platinum acier ink

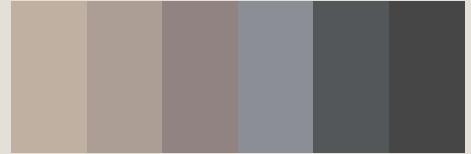

Season

burgundy petal ocean sky forest mint

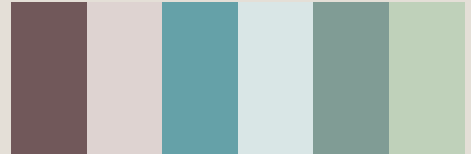





Ra/NCS



BASE NUDECOMPLEMENTOS

Rejilla

		Textura	Medidas (cm)	Standard	Nat. Made	Season	RaL/NCS
	Rejilla Mia inox	-	12 x 12	<input checked="" type="checkbox"/>	<input checked="" type="checkbox"/>	<input checked="" type="checkbox"/>	<input checked="" type="checkbox"/>
	Rejilla Mia Akron	Nude	12 x 12	<input checked="" type="checkbox"/>	<input checked="" type="checkbox"/>	<input checked="" type="checkbox"/>	<input checked="" type="checkbox"/>
	Rejilla Geo Akron	Nude	12 x 12	<input checked="" type="checkbox"/>	<input checked="" type="checkbox"/>	<input checked="" type="checkbox"/>	<input checked="" type="checkbox"/>
	Rejilla Lux Akron	Nude	12 x 12	<input checked="" type="checkbox"/>	<input checked="" type="checkbox"/>	<input checked="" type="checkbox"/>	<input checked="" type="checkbox"/>

NOTA: incluido un solo modelo de rejilla por plato de ducha, a elegir entre: Mia, Geo o Lux.

Desagües (mm)

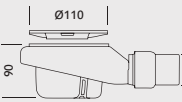
	Desagüe estándar			<input checked="" type="checkbox"/>
	Desagüe vertical			<input checked="" type="checkbox"/>
	Desagüe extraplano			<input type="checkbox"/>
	Desagüe gran caudal			<input type="checkbox"/>

NOTA: incluido un solo modelo de desagüe por plato de ducha.

Moldura

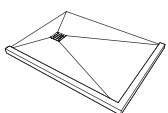
		Textura	Medidas (cm)	
	Moldura	Nude	4,1 x 5	<input type="checkbox"/>

Zócalo de elevación

		Textura	Medidas (cm)	
	Zócalo	Nude	60 - 200 x 9 x 1,6	<input type="checkbox"/>

Materiales para la instalación



Set básico de impermeabilización

Kerdi-TS Schlüter Systems



Cola de pegado

Ultrabond MS Rapid

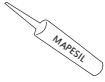

Silicona sellado juntas

Mapesil AC



BASE NUDE INFORMACIÓN TÉCNICA

Corte a medida

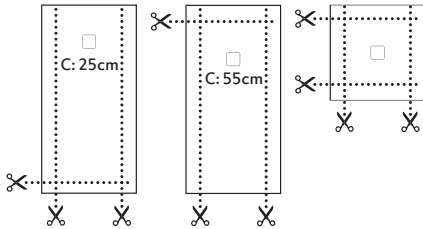

Dimensiones

	A (cm)	B (cm)	C (cm)		A (cm)	B (cm)	C (cm)
	100	80/90	25		100	100	50
	120	80/90/100	25				
	140	80/90	55				
	150	80/90/100	55				
	170	80/90/100	55				
	190	80/90	55				
	200	80/90/100	55				

Ensayos

Textura	Ensayo	Resultado
NUDE	UNE-EN 16165:2022 Anexo A	CLASE B
	Normativa francesa XP P 05-010	PN 18

Ficha técnica de producto



Manual de instalación





Arq Zero

Como si de una obra de arte se tratase, un marco recorre el perímetro del plato de ducha a medida Arq Zero. Este modelo se adapta a las últimas tendencias a la vez que presume de un diseño atemporal gracias a la microtextura Zero de Acquabella. Una elección infalible a la hora de renovar el plato de ducha de tu cuarto de baño.

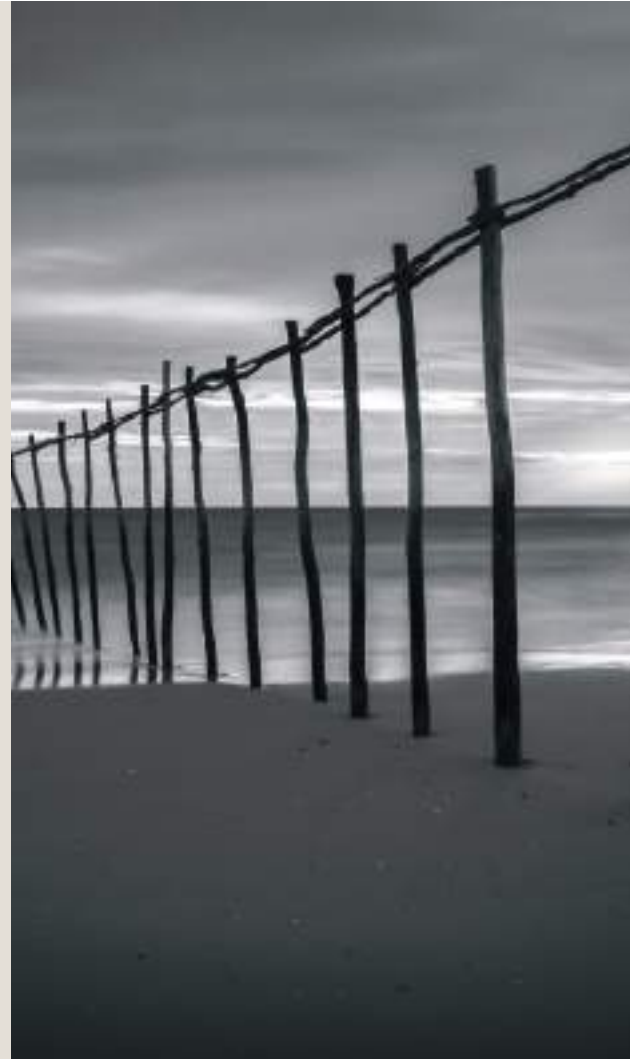

Dimensiones estándar (cm)

70 x

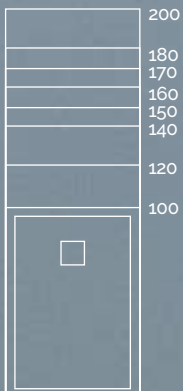

80 x

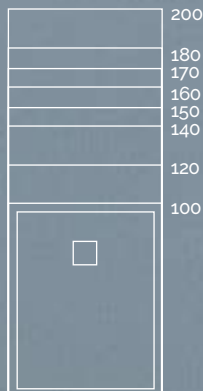

90 x

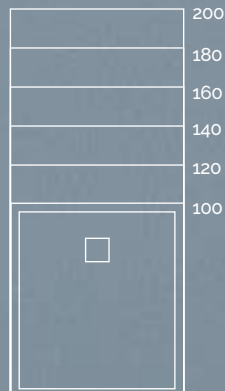

100 x

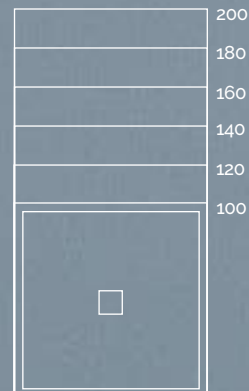

Rejillas disponibles

Mia inox



Mia



Geo



Lux







Arq Zero



Arq Zero blanco 200x100 cm



Colores

Standard

blanco nacar beige marfil crema

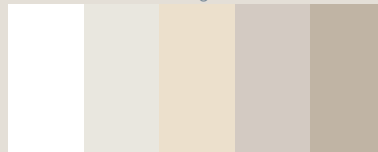

grey cemento moka lava negro



Naturally Made

sand capuccino fango platinum acier ink



Season

burgundy petal ocean sky forest mint

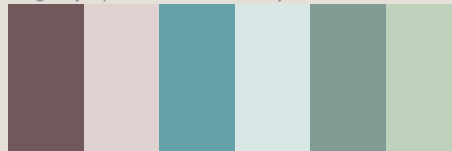





Ra/NCS



ARQ ZERO COMPLEMENTOS

Rejilla

		Textura	Medidas (cm)	Standard	Nat. Made	Season	RaL/NCS
	Rejilla Mia inox	-	12 x 12	✓	✓	✓	✓
	Rejilla Mia Akron	Zero	12 x 12	✓	✓	✓	✓
	Rejilla Geo Akron	Zero	12 x 12	✓	✓	✓	✓
	Rejilla Lux Akron	Zero	12 x 12	✓	✓	✓	✓

NOTA: incluido un solo modelo de rejilla por plato de ducha, a elegir entre: Mia, Geo o Lux.

Desagües (mm)



	Desagüe estándar			✓
	Desagüe vertical			✓
	Desagüe extraplano			🛒
	Desagüe gran caudal			🛒

NOTA: incluido un solo modelo de desagüe por plato de ducha.

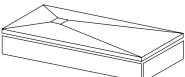
Zócalo de elevación

		Textura	Medidas (cm)	
	Zócalo	Zero	60 - 200 x 9 x 1,6	🛒

Materiales para la instalación

	Set básico de impermeabilización	Kerdi-TS Schlüter Systems	🛒
	Cola de pegado	Ultrabond MS Rapid	🛒
	Silicona sellado juntas	Mapesil AC	🛒

Dimensiones

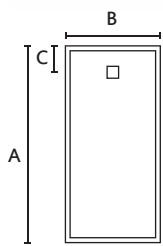
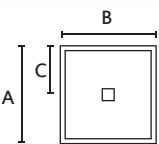
		A (cm)	B (cm)	C (cm)			A (cm)	B (cm)	C (cm)
	100	70/80/90	25		100	100	50		
	120	70/80/90/100	25						
	140	70/80/90/100	25						
	150	70/80	25						
	160	70/80/90/100	25						
	170	70/80	25						
	180	70/80/90/100	25						
	200	70/80/90/100	25						

Ensayos

Textura	Ensayo	Resultado
ZERO	UNE-EN 16165:2022 Anexo A	CLASE C
	Normativa francesa XP P 05-010	PN 24

Ficha técnica de producto



Manual de instalación





Unic Slate

Inspirado en el movimiento Neo Art Decó, Acquabella presenta el plato de ducha Unic. Este vanguardista estilo decorativo caracterizado por las formas geométricas y el lujo de sus materiales, quedan representados en el original Unic Slate. El plato de ducha Unic dibuja un elegante arco de suaves pendientes que enmarca una moderna rejilla, todo ello en textura Slate.



Dimensiones estándar (cm)

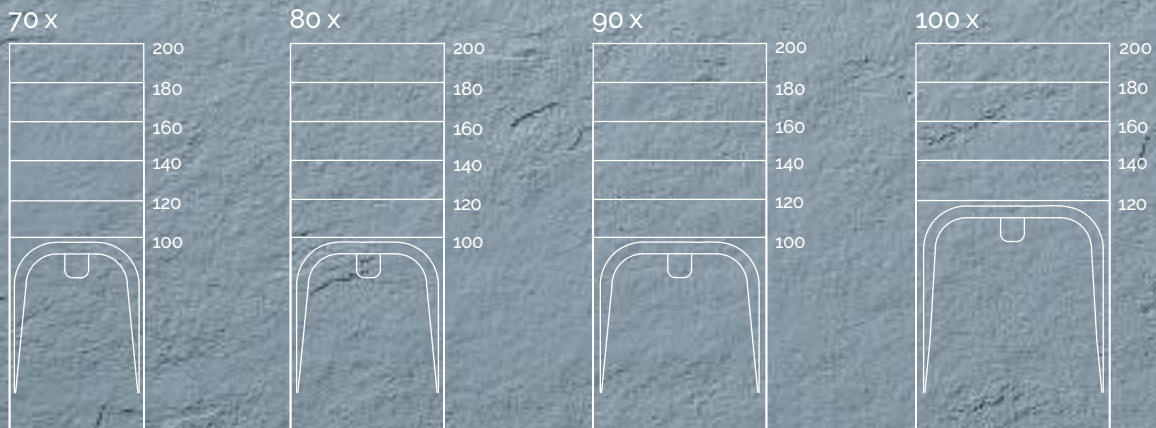

Rejillas disponibles

Deco



Dune



Drop

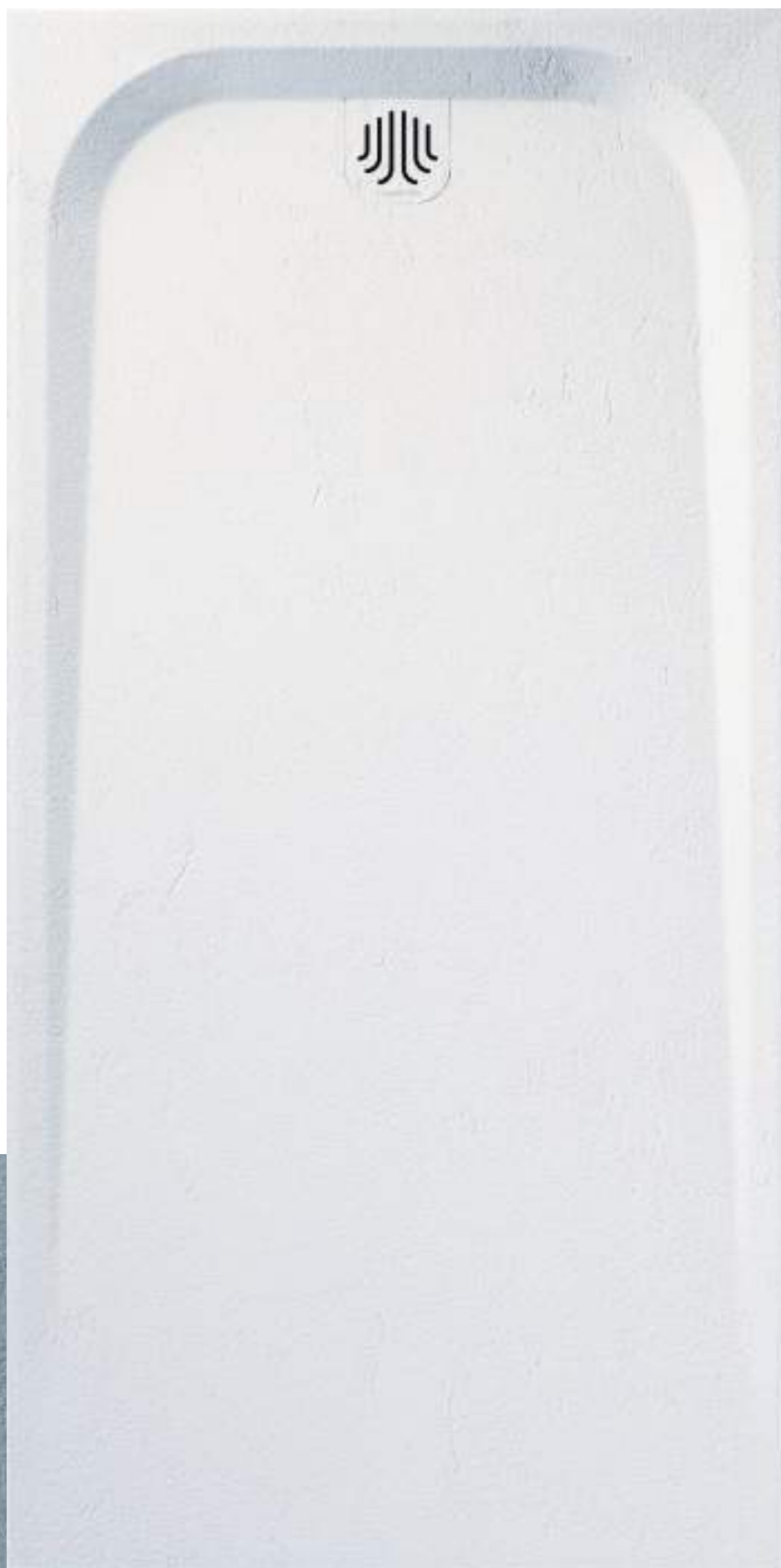

Unic Slate

El plato de ducha Unic ha llegado para romper con todos los esquemas gracias a 3 innovadores diseños de rejillas disponibles: Deco, Dune y Drop. Esta elección nos permite dar un paso más en la personalización del plato de ducha, consiguiendo así el efecto deseado.

Deco





Unic Deco Slate petal 160x90 cm

Dune

Drop

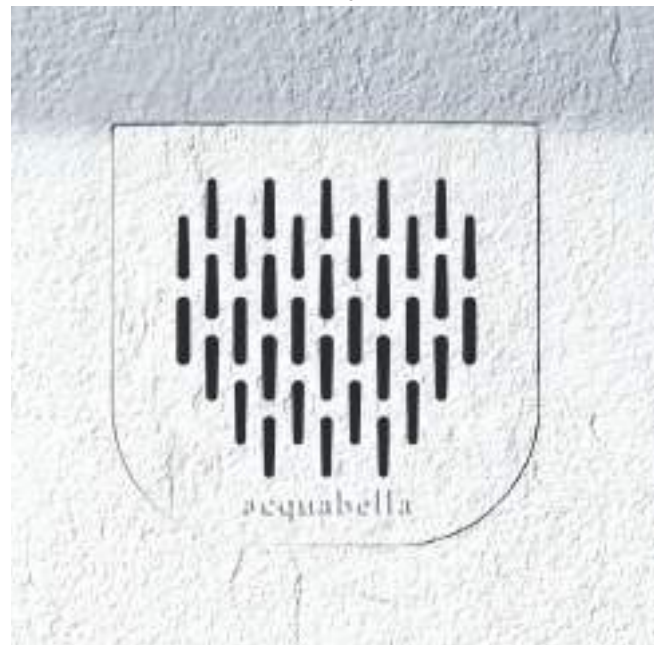





Unic Slate



Unic Drop Slate NCS S 5540-R90B 200x100 cm



Colores

Standard

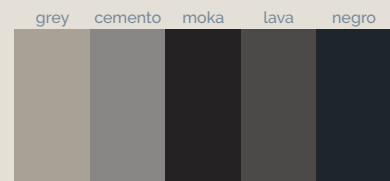
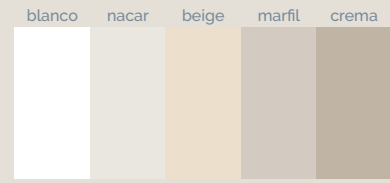

Naturally Made

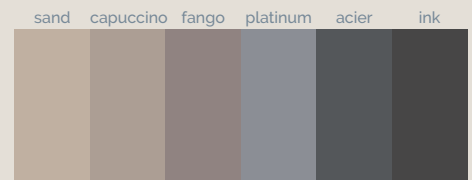

Season

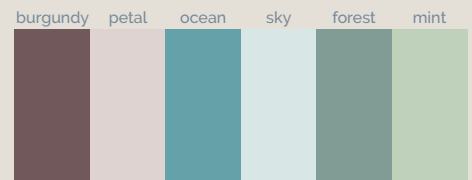



Ra/NCS



UNIC SLATECOMPLEMENTOS

Rejilla

		Textura	Medidas (cm)	Standard	Nat. Made	Season	RaL/NCS
	Rejilla Deco Akron	Slate	12,1 x 12	✓	✓	✓	✓
	Rejilla Dune Akron	Slate	12,1 x 12	✓	✓	✓	✓
	Rejilla Drop Akron	Slate	12,1 x 12	✓	✓	✓	✓

NOTA: incluido un solo modelo de rejilla por plato de ducha, a elegir entre: Deco, Dune o Drop.

Desagües (mm)

	Desagüe estándar			✓
	Desagüe vertical			✓
	Desagüe extraplano			🛒
	Desagüe gran caudal			🛒

NOTA: incluido un solo modelo de desagüe por plato de ducha.

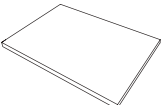

Zona de secado

		Textura	Medidas (cm)	
	Zona de secado	Slate	100 x 100 x 2,3	🛒

Zócalo de elevación

		Textura	Medidas (cm)	
	Zócalo	Slate	60 - 200 x 9 x 1,6	🛒

Materiales para la instalación

	Set básico de impermeabilización	Kerdi-TS Schlüter Systems	🛒
	Cola de pegado	Ultrabond MS Rapid	🛒
	Silicona sellado juntas	Mapesil AC	🛒

Corte a medida

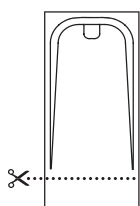

Dimensiones

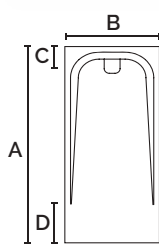
	A (cm)	B (cm)	C (cm)	D (cm)
	100	70/80/90	15,1	20
	120	70/80/90/100	15,1	20
	140	70/80/90/100	15,1	20
	160	70/80/90/100	15,1	20
	180	70/80/90/100	15,1	20
	200	70/80/90/100	15,1	20

Ensayos

Textura	Ensayo	Resultado
SLATE	UNE-EN 16165:2022 Anexo A	CLASE C
	Normativa francesa XP P 05-010	PN 24

Ficha técnica de producto



Manual de instalación





Halo Slate

El minimalismo nos envuelve de la mano de Halo Slate, un plato de ducha de diseño enmarcado. Este se caracteriza por un marco liso de dulces caídas, que crea un sutil contraste con la definición de la piedra pizarra. Halo Slate se corona con una alargada rejilla que se integra en la forma del marco, ofreciendo así una elevada evacuación de agua.



Dimensiones estándar (cm)

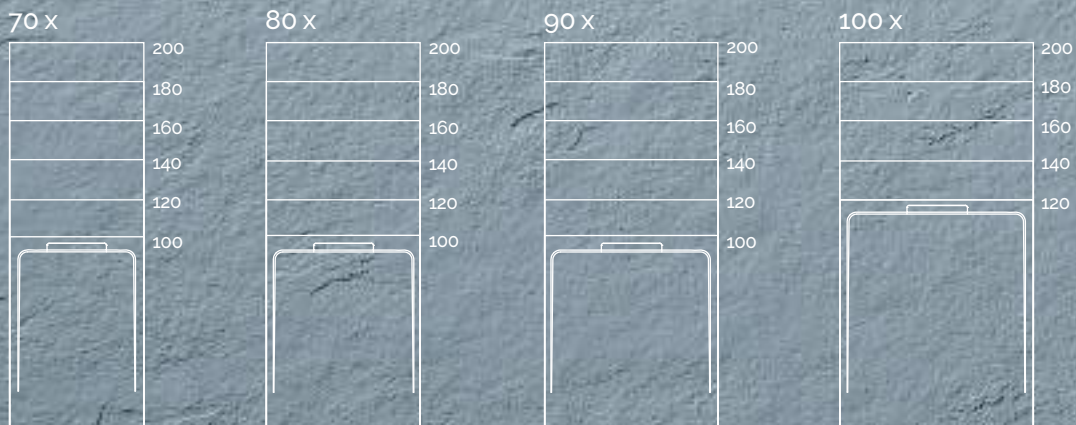







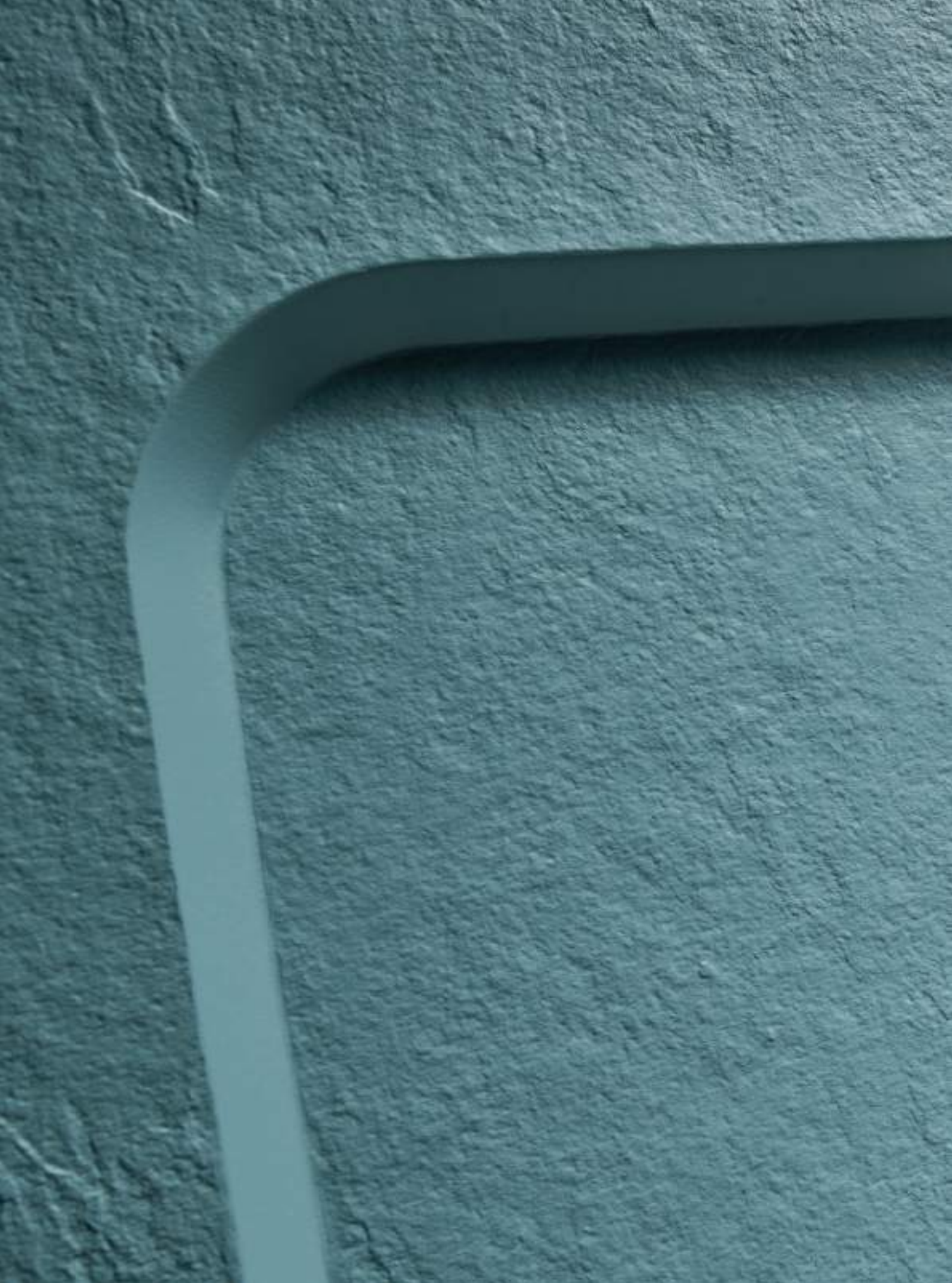



Halo Slate



Halo Slate negro 200x100 cm



Colores

Standard

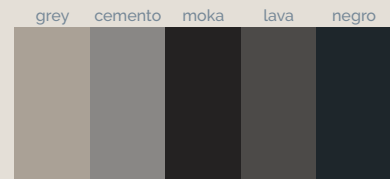
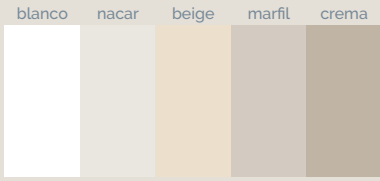

Naturally Made

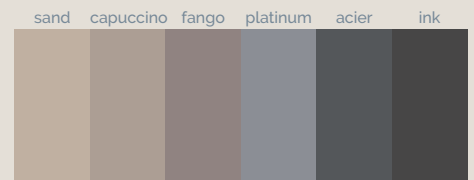

Season

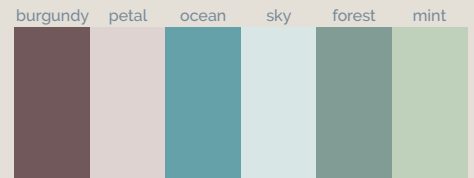





Ra/NCS



HALO SLATECOMPLEMENTOS



Tapa

	Textura	Medidas (cm)	Standard	Nat. Made	Season	RaL/NCS
 Tapa Akron	Slate	31,2 x 3,5				

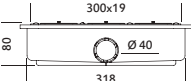

Desagüe (mm)

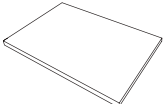
 Desagüe line estándar						
---	--	--	--	--	--	---

Zona de secado

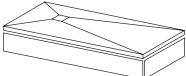

	Textura	Medidas (cm)	
 Zona de secado	Slate	100 x 100 x 2,3	

Zócalo de elevación

	Textura	Medidas (cm)	
 Zócalo	Slate	60 - 200 x 9 x 1,6	

Materiales para la instalación

 Set básico de impermeabilización	Kerdi-TS Schlüter Systems	
--	---------------------------	---

 Cola de pegado	Ultrabond MS Rapid	
--	--------------------	---

 Silicona sellado juntas	Mapesil AC	
---	------------	---

Corte a medida

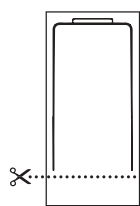

Dimensiones



A (cm)	B (cm)	C (cm)	D (cm)	E (cm)
100	70/80	4,4	20	40
100	90	4,4	20	50
120	70/80	4,4	20	40
120	90/100	4,4	20	50
140	70/80	4,4	20	40
140	90/100	4,4	20	50
160	70/80	4,4	20	40
160	90/100	4,4	20	50
180	70/80	4,4	20	40
180	90/100	4,4	20	50
200	70/80	4,4	20	40
200	90/100	4,4	20	50

Ensayos

Textura	Ensayo	Resultado
SLATE	UNE-EN 16165:2022 Anexo A	CLASE C
	Normativa francesa XP P 05-010	PN 24

Ficha técnica de producto



Manual de instalación





Areia Slate Evo

Inspirado en la erosión que provoca el mar en la roca, Acquabella presenta el plato de ducha a medida Areia Slate Evo. Su diseño sencillo lleva la experiencia de ducha a otro nivel gracias a una textura Slate Evo, una nueva versión de la tradicional textura Slate que se degrada progresivamente hasta alcanzar la rejilla.



Dimensiones estándar (cm)

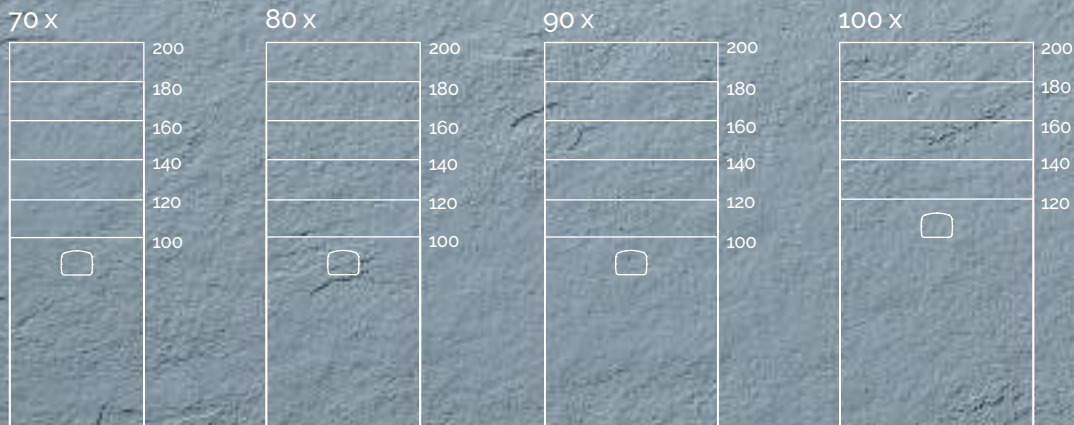

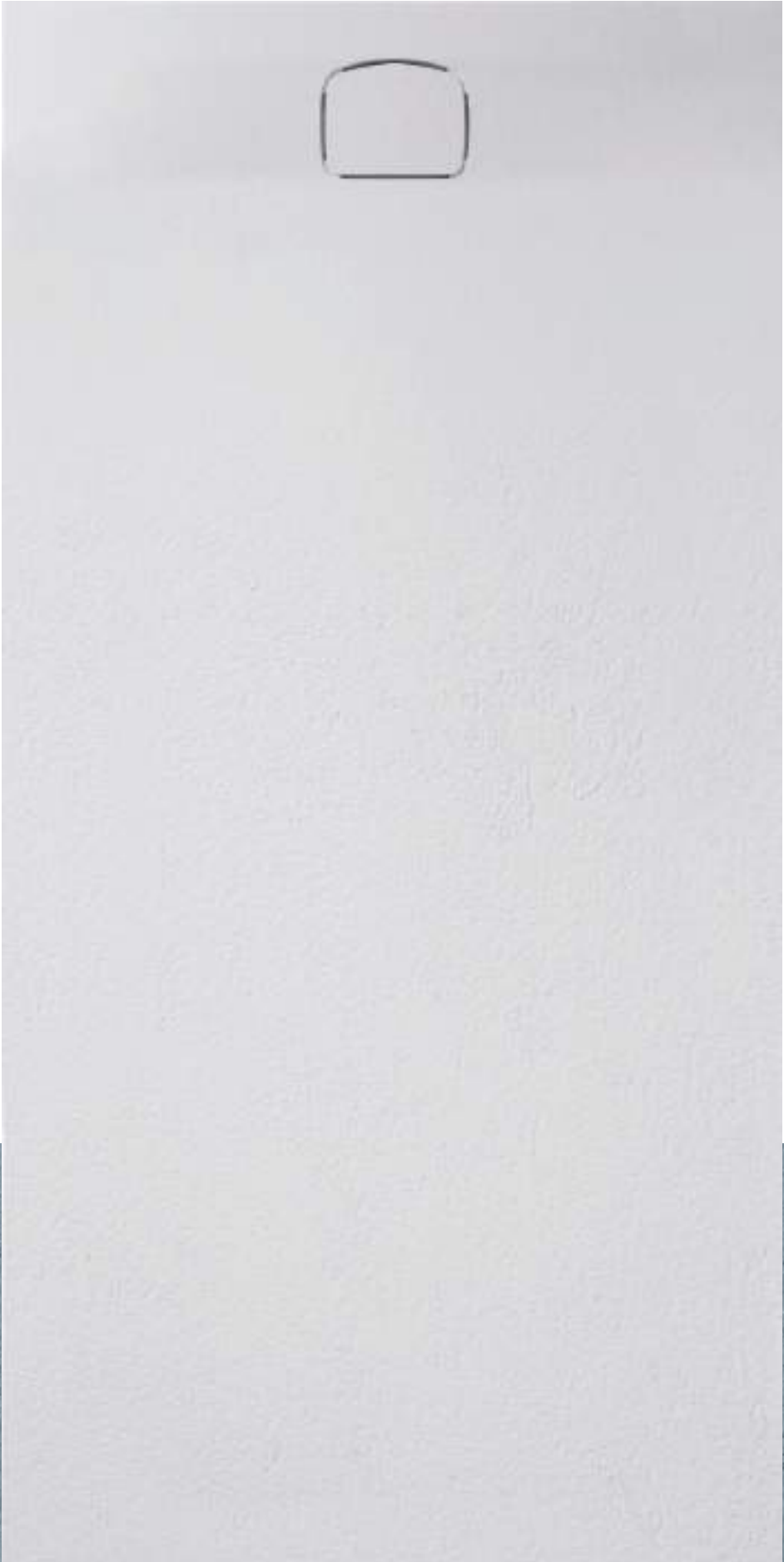

Areia Slate Evo

El modelo Areia posee una rejilla rectangular de cantos redondeados que encaja a la perfección con la suave pendiente del plato de ducha.





Areia Slate Evo marfil 180x90 cm

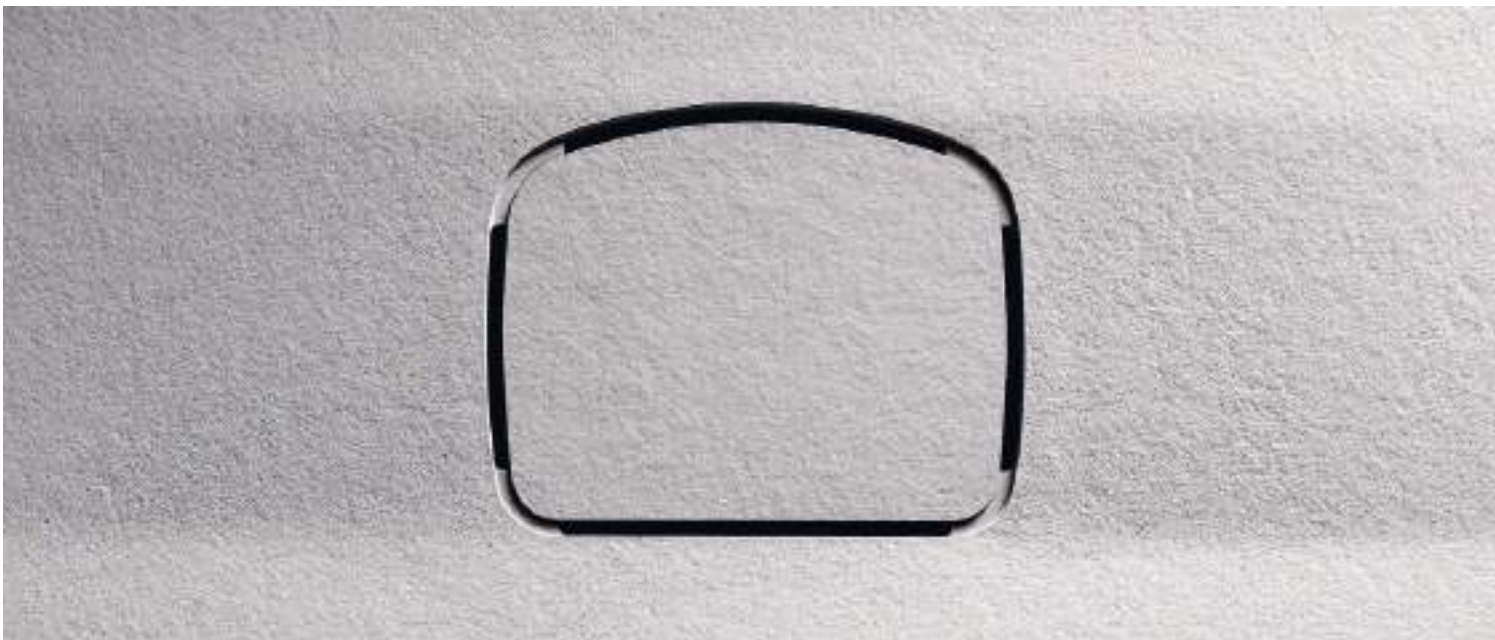

Areia Slate Evo marfil 180x90 cm 87





Areia Slate Evo



Areia Slate Evo NCS S 3030-Y80R 200x100 cm

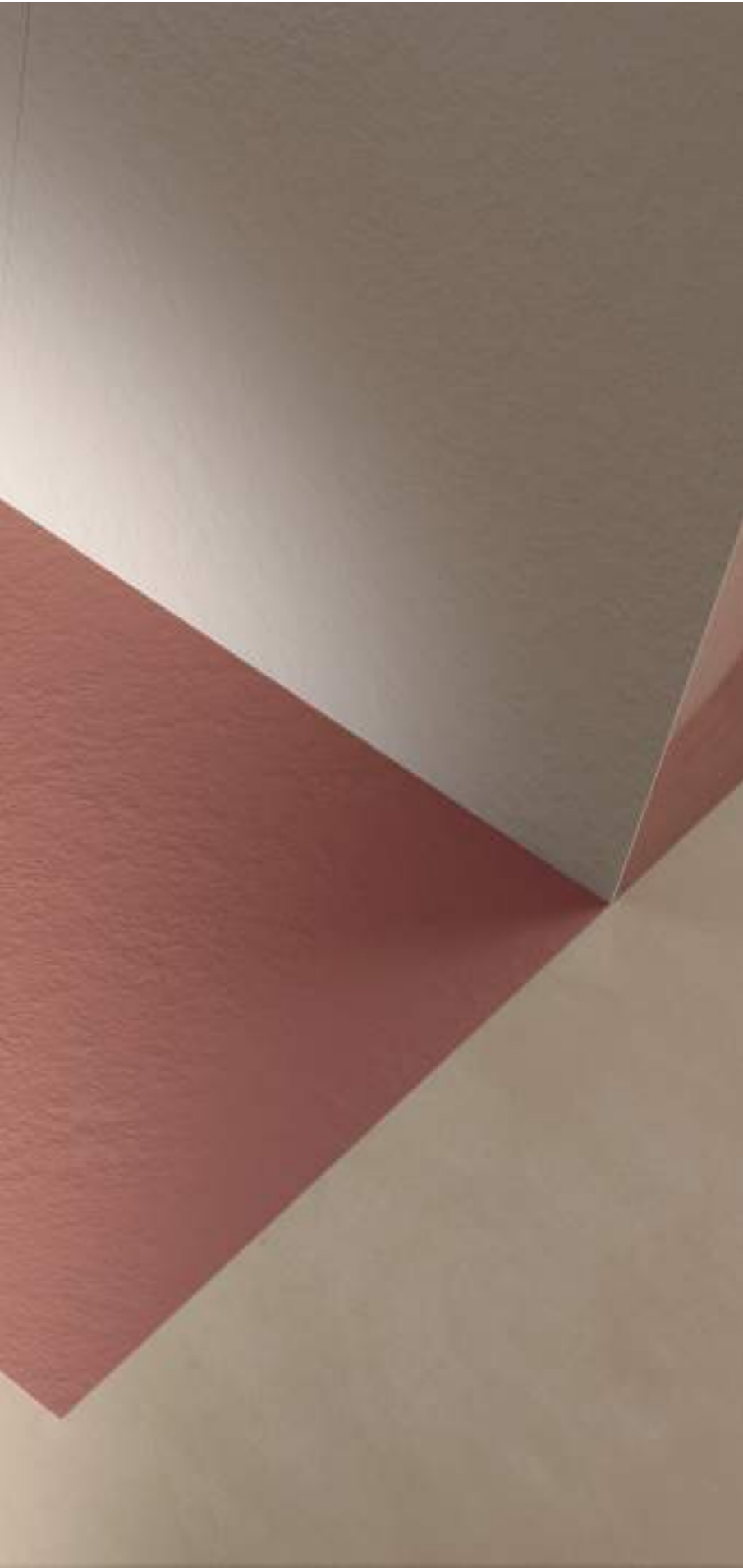

Colores

Standard

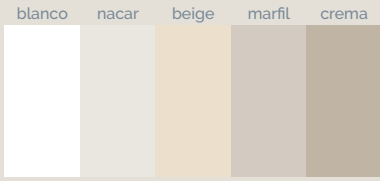

Naturally Made

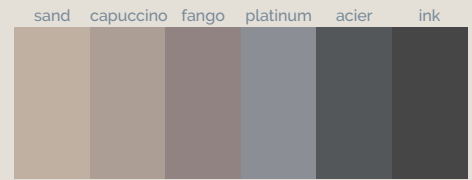

Season

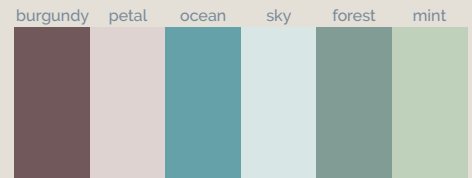





Ra/NCS



AREIA SLATE EVOCOMPLEMENTOS

Tapa

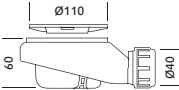

		Textura	Medidas (cm)	Standard	Nat. Made	Season	RaL/NCS
	Tapa Akron	Slate Evo	16 x 12,5				

Desagües (mm)





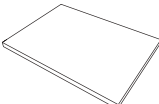

	Desagüe estándar	
	Desagüe vertical	
	Desagüe extraplano	
	Desagüe gran caudal	

NOTA: incluido un solo modelo de desagüe por plato de ducha.

Zona de secado

		Textura	Medidas (cm)	
	Zona de secado	Slate	100 x 100 x 2,3	

Materiales para la instalación

	Set básico de impermeabilización	Kerdi-TS Schlüter Systems	
	Cola de pegado	Ultrabond MS Rapid	
	Silicona sellado juntas	Mapesil AC	

Corte a medida

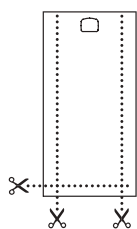

Dimensiones

	A (cm)	B (cm)	C (cm)
	100	70/80/90	13,1
	120	70/80/90/100	13,1
	140	70/80/90/100	13,1
	160	70/80/90/100	13,1
	180	70/80/90/100	13,1
	200	70/80/90/100	13,1

Ensayos

Textura	Ensayo	Resultado
SLATE EVO	UNE-EN 16165:2022 Anexo A	CLASE C
	Normativa francesa XP P 05-010	PN 24

Ficha técnica de producto



Manual de instalación





Natur Wave

Acquabella presenta la textura Wave. Su diseño está inspirado en los patrones dinámicos que podemos observar en la naturaleza. Unos anillos de diferentes rugosidades que abrazan y dibujan una rejilla irregular, dando lugar al modelo Natur. El resultado es un plato de ducha que derrocha diseño y personalidad por los cuatro costados.



reddot winner 2023

Dimensiones estándar (cm)

70 x

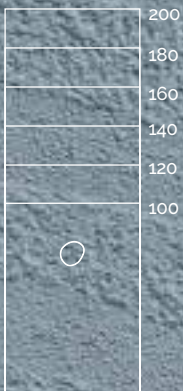

80 x

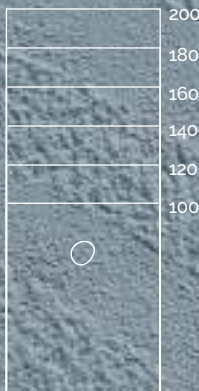

90 x

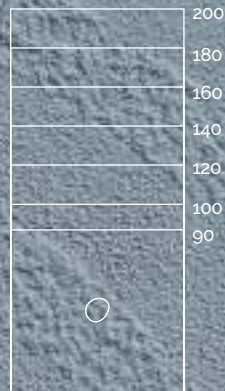

100 x

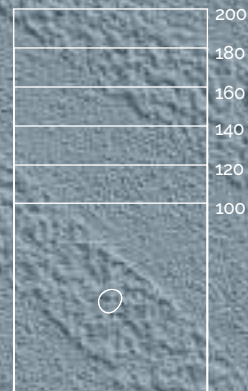











Natur Wave



Natur Wave crema 200x100 cm



Colores

Standard

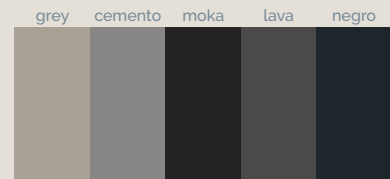
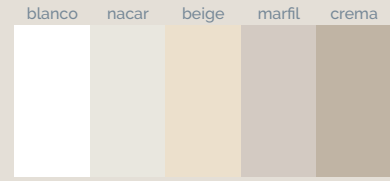

Naturally Made

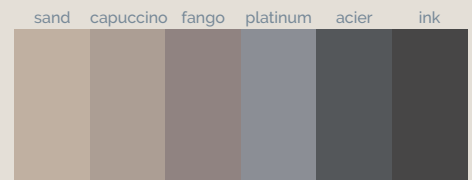

Season

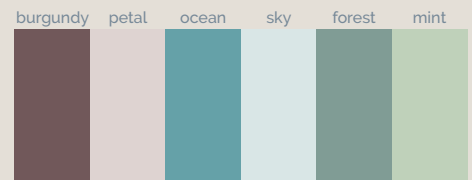





Ra/NCS



NATUR WAVECOMPLEMENTOS

Rejilla







		Textura	Medidas (cm)	Standard	Nat. Made	Season	Ra/NCS
	Rejilla Akron	Wave	14 x 13,9				

Desagües (mm)

	Desagüe estándar	
	Desagüe vertical	
	Desagüe extraplano	
	Desagüe gran caudal	

NOTA: incluido un solo modelo de desagüe por plato de ducha.

Materiales para la instalación

	Set básico de impermeabilización	Kerdi-TS Schlüter Systems	
	Cola de pegado	Ultrabond MS Rapid	
	Silicona sellado juntas	Mapesil AC	

Corte a medida

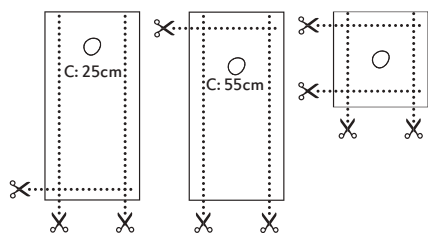

Dimensiones

A (cm)	B (cm)	C (cm)			A (cm)	B (cm)	C (cm)		
		100	70/80/90	25			90	90	45
120	70/80/90/100	25	90	90	45				
140	70/80/90/100	55	100	100	50				
160	70/80/90/100	55							
180	70/80/90/100	55							
200	70/80/90/100	55							

Ensayos

Textura	Ensayo	Resultado
WAVE	UNE-EN 16165:2022 Anexo A	CLASE C
	Normativa francesa XP P 05-010	PN 24

Ficha técnica de producto



Manual de instalación





Smart Quiz

El plato de ducha Smart Quiz representa el ADN de Acquabella: vanguardia, creatividad e inconformismo. Un innovador diseño que se caracteriza por el puzle geométrico que conforman las texturas Beton, Zero y Ethnic. El plato de ducha a medida Smart Quiz cuenta con una rejilla central, totalmente integrada en las formas del plato de ducha, ocultando el desagüe.



Dimensiones estándar (cm)

70 x

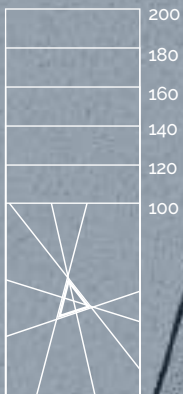

80 x



90 x

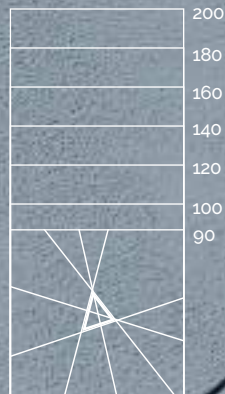

100 x

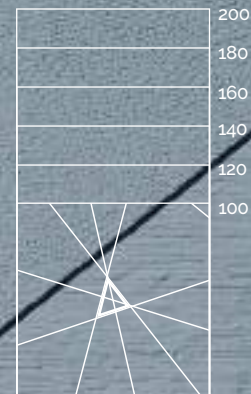

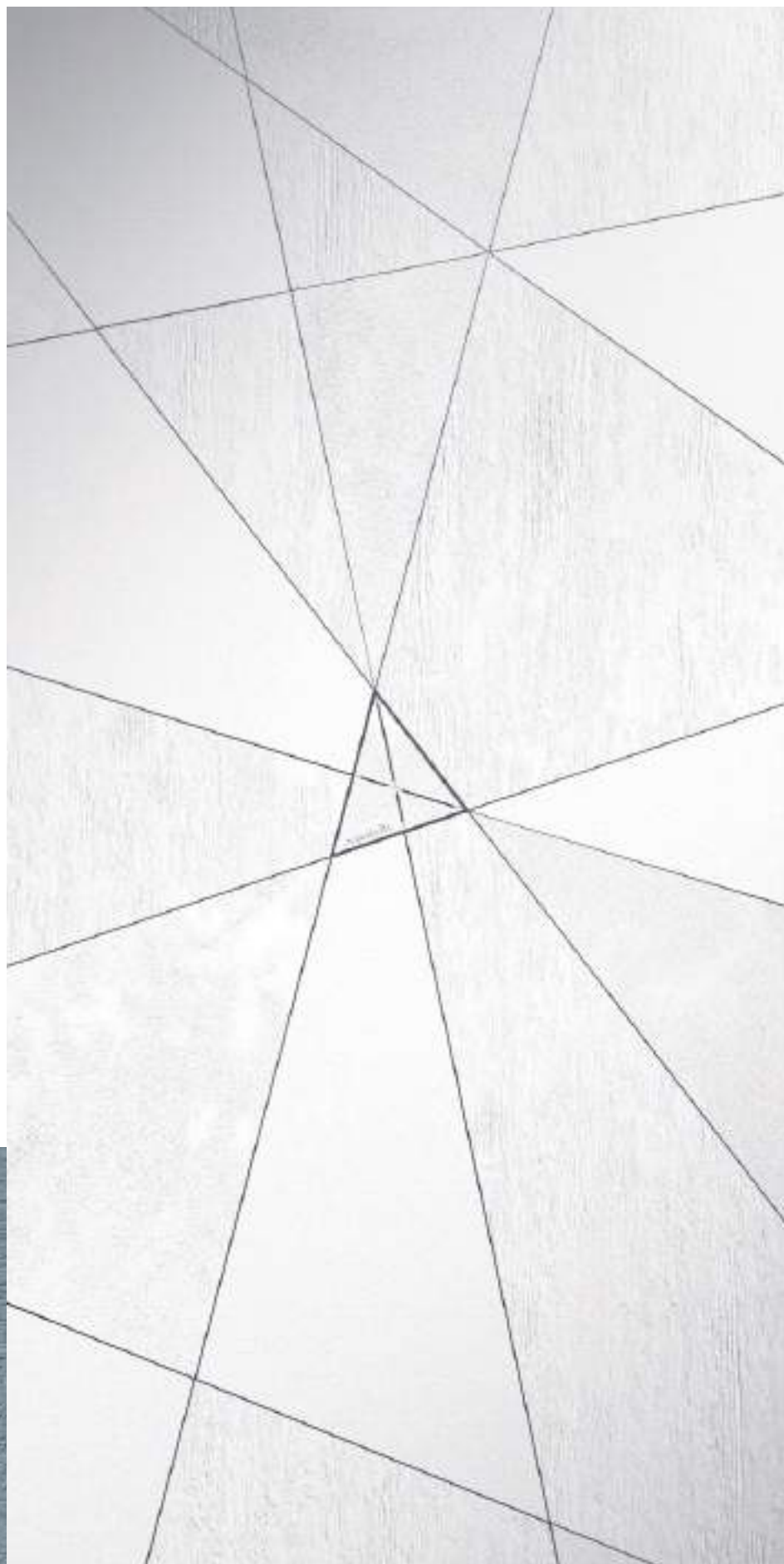





Smart Quiz



Smart Quiz negro 200x100 cm



Colores

Standard

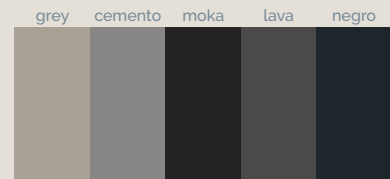
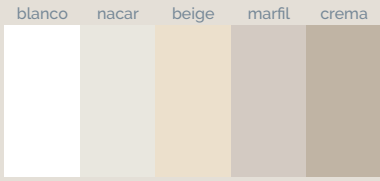

Naturally Made

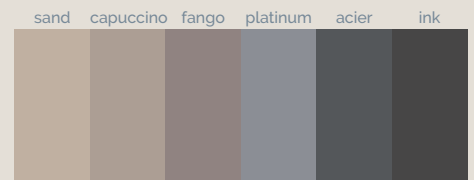

Season

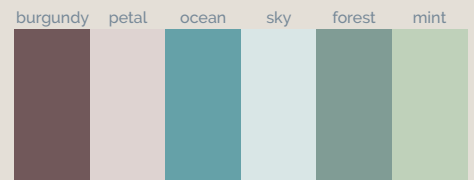

Ra/NCS



SMART QUIZ COMPLEMENTOS

Rejilla



	Textura	Medidas (cm)	Standard	Nat. Made	Season	RaL/NCS
 Rejilla Akron	Beton	17,6 x 17,6	<input checked="" type="checkbox"/>	<input checked="" type="checkbox"/>	<input checked="" type="checkbox"/>	<input checked="" type="checkbox"/>

Desagües (mm)

 Desagüe estándar	<input checked="" type="checkbox"/>
 Desagüe vertical	<input checked="" type="checkbox"/>
 Desagüe extraplano	<input type="checkbox"/>
 Desagüe gran caudal	<input type="checkbox"/>

NOTA: incluido un solo modelo de desagüe por plato de ducha.

Materiales para la instalación

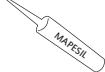
 Set básico de impermeabilización	Kerdi-TS Schlüter Systems	<input type="checkbox"/>
 Cola de pegado	Ultrabond MS Rapid	<input type="checkbox"/>
 Silicona sellado juntas	Mapesil AC	<input type="checkbox"/>

Corte a medida

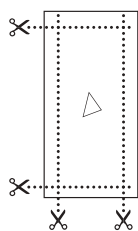

Dimensiones

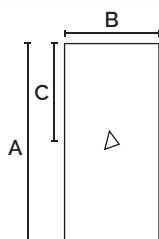

A (cm)	B (cm)	C (cm)
90	90	45
100	70/80/90/100	50
120	70/80/90/100	60
140	70/80/90/100	70
160	70/80/90/100	80
180	70/80/90/100	90
200	70/80/90/100	100

Ensayos

Textura	Ensayo	Resultado
QUIZ	UNE-EN 16165:2022 Anexo A	CLASE B
	Normativa francesa XP P 05-010	PN 18

Ficha técnica de producto



Manual de instalación





Tempo Arabba

Tempo Arabba representa una vuelta a los orígenes, marcados por el diseño y la artesanía. De aspecto textil, simula fibras naturales tejidas a mano con el mismo cuidado con el que realizamos nuestros productos. Su dibujo juega con nuestra percepción visual, fundiéndose con un acabado de piedra. Una textura que se muestra fiel a nuestra voluntad de ser diferentes.



Dimensiones estándar (cm)

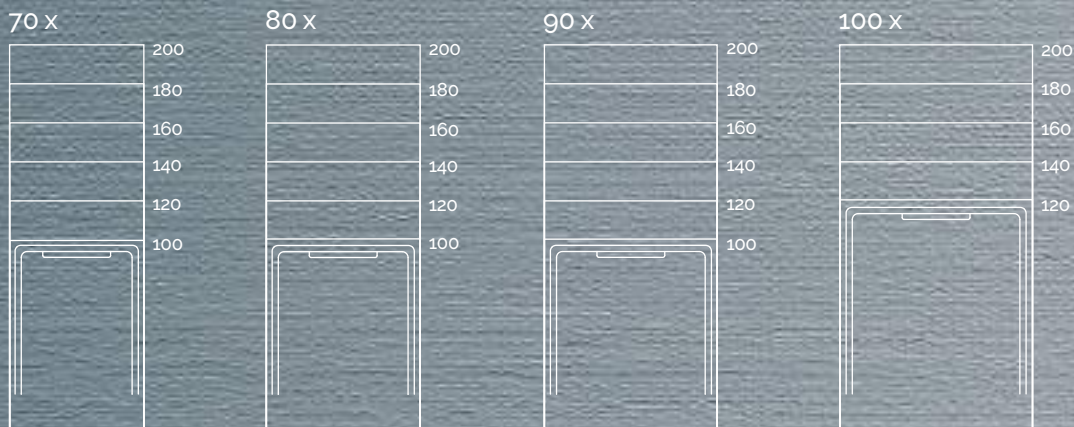







Tempo Arabba



Tempo Arabba blanco 200x100 cm



Colores

Standard

blanco nacar beige marfil crema

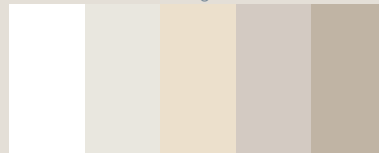

grey cemento moka lava negro

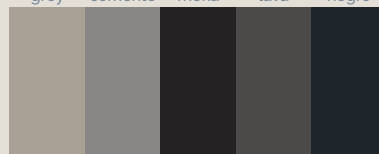

Naturally Made

sand capuccino fango platinum acier ink



Season

burgundy petal ocean sky forest mint

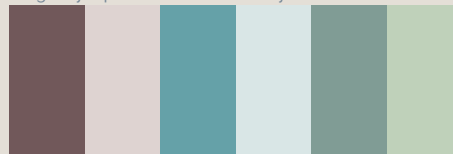





Ra/NCS



TEMPO ARABBA COMPLEMENTOS



Tapa

	Textura	Medidas (cm)	Standard	Nat. Made	Season	Ra/NCS
 Tapa Akron	Arabba	34,6 x 2,8				





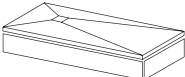

Desagüe (mm)

 Desagüe line estándar						
---	--	--	--	--	--	---

Zócalo de elevación

	Textura	Medidas (cm)	
 Zócalo	Arabba	60 - 200 x 9 x 1,6	

Materiales para la instalación

 Set básico de impermeabilización	Kerdi-TS Schlüter Systems	
 Cola de pegado	Ultrabond MS Rapid	
 Silicona sellado juntas	Mapesil AC	

Corte a medida

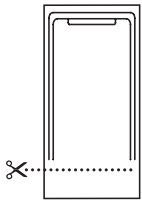

Dimensiones

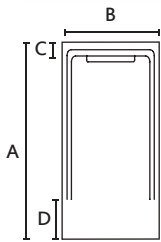
	A (cm)	B (cm)	C (cm)	D (cm)
	100	70/80/90	7,4	20
	120	70/80/90/100	7,4	20
	140	70/80/90/100	7,4	20
	160	70/80/90/100	7,4	20
	180	70/80/90/100	7,4	20
	200	70/80/90/100	7,4	20

Ensayos

Textura	Ensayo	Resultado
ARABBA	UNE-EN 16165:2022 Anexo A	CLASE C
	Normativa francesa XP P 05-010	PN 24

Ficha técnica de producto



Manual de instalación





Flow Zero

El plato de ducha Flow Zero ha sido concebido para fundirse con el agua. Su diseño nos sumerge en un universo de calma y relajación gracias a un depurado estilo minimalista. Sus suaves pendientes, en consonancia con la textura Zero, dirigen el agua hacia una rejilla integrada en el marco, capaz de asumir el gran caudal que fluye por su superficie.



Dimensiones estándar (cm)

70 x



80 x

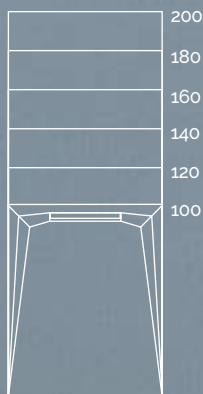

90 x

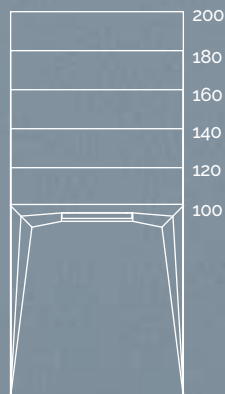

100 x

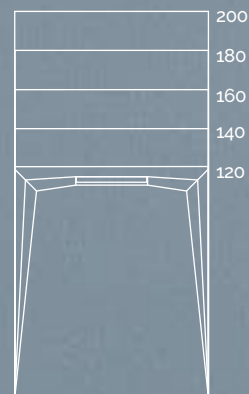







Flow Zero



Flow Zero NCS S 4020-RgOB 200x100 cm



Colores

Standard

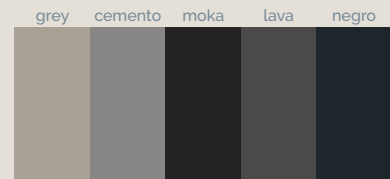
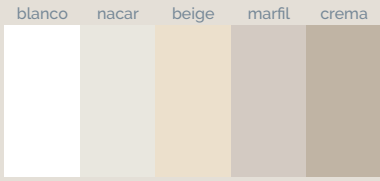

Naturally Made

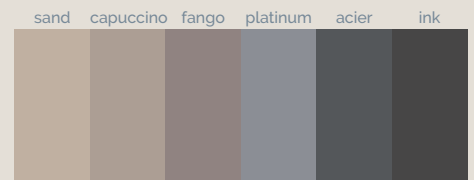

Season

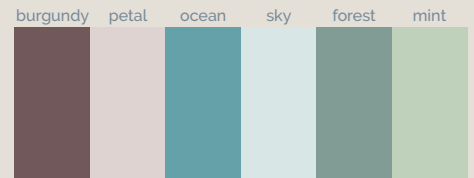





Ra/NCS



FLOW ZERO COMPLEMENTOS



Tapa

	Textura	Medidas (cm)	Standard	Nat. Made	Season	RaL/NCS
 Tapa Akron	Zero	36,1 x 3				

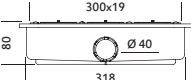



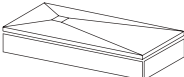

Desagüe (mm)

 Desagüe line estándar						
---	--	--	--	--	--	---

Zócalo de elevación

	Textura	Medidas (cm)	
 Zócalo	Zero	60 - 200 x 9 x 1,6	

Materiales para la instalación

 Set básico de impermeabilización	Kerdi-TS Schlüter Systems	
 Cola de pegado	Ultrabond MS Rapid	
 Silicona sellado juntas	Mapesil AC	

Dimensiones



Diagrama de un plato de ducha con dimensiones A, B y C indicadas. A es la altura total, B es el ancho superior y C es el espesor.

	A (cm)	B (cm)	C (cm)
	100	70/80/90	5,6
	120	70/80/90/100	5,6
	140	70/80/90/100	5,6
	160	70/80/90/100	5,6
	180	70/80/90/100	5,6
	200	70/80/90/100	5,6

Ensayos

Textura	Ensayo	Resultado
ZERO	UNE-EN 16165:2022 Anexo A	CLASE C
	Normativa francesa XP P 05-010	PN 24

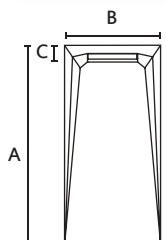
Ficha técnica de producto



Manual de instalación





Focus Beton

Las tendencias son cíclicas pero las formas geométricas siempre están presentes en el diseño. Acquabella quiere transmitir esa sensación de unidad y perfección a través del plato de ducha Focus. Combina la textura de aspecto cemento Beton con el aro metálico que más te guste en la zona del desagüe, consiguiendo armonía matérica.

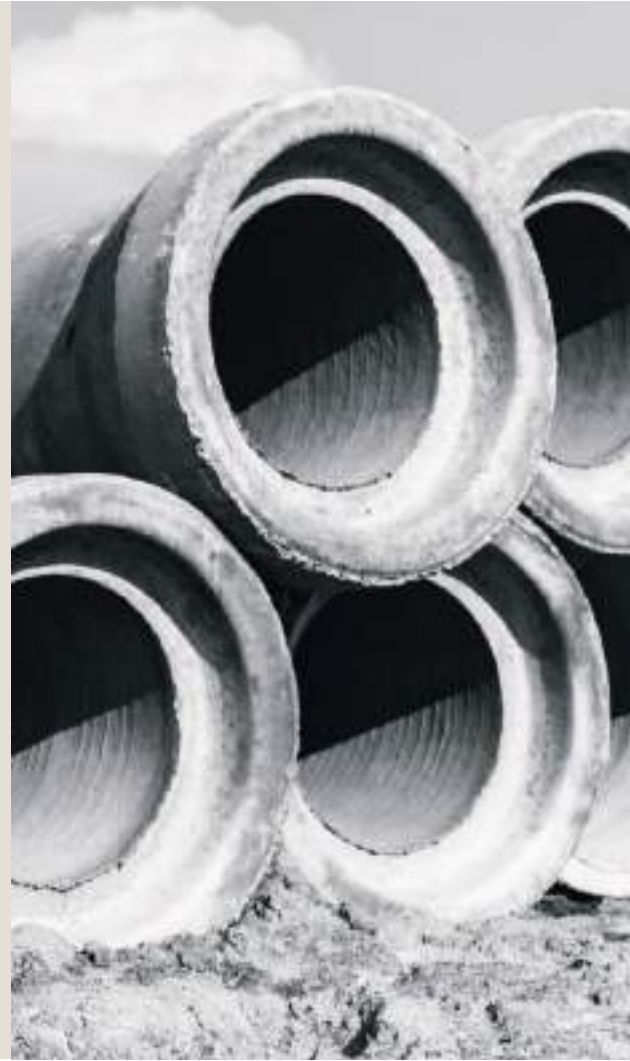

Dimensiones estándar (cm)

80 x

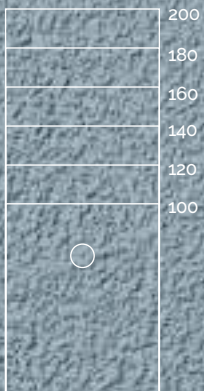

90 x

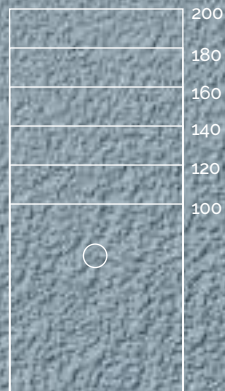

100 x

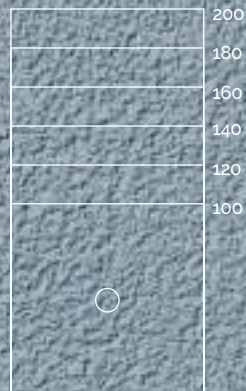

Embelledores disponibles

Inox



Cobre



Negro



Blanco







Focus Beton



Focus cobre Beton blanco 200x100 cm

Colores

Standard

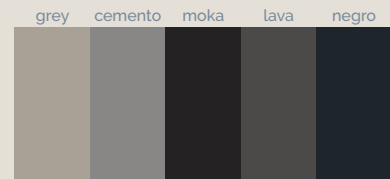
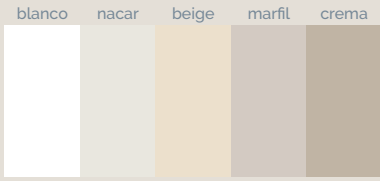

Naturally Made

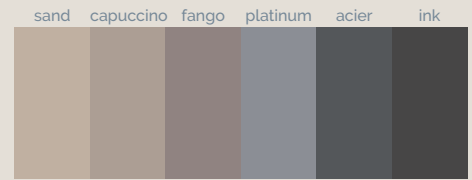

Season

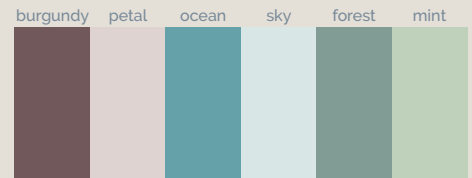

Ra/NCS







FOCUS BETON COMPLEMENTOS

Rejilla

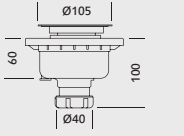
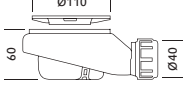

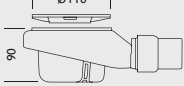
		Textura	Medidas (cm)	Standard	Nat. Made	Season	RaL/NCS
	Rejilla Akron	Beton	Ø 10,6				
	Embellecedor	Inox / Cobre / Negro / Blanco	Ø 12,9				

Desagües (mm)

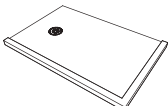

	Desagüe estándar						
	Desagüe vertical						
	Desagüe extraplano						
	Desagüe gran caudal						

NOTA: incluido un solo modelo de desagüe por plato de ducha.







Moldura

		Textura	Medidas (cm)	
	Moldura	Beton	4,1 x 5	

Zócalo de elevación

		Textura	Medidas (cm)	
	Zócalo	Beton	60 - 200 x 9 x 1,6	

Materiales para la instalación

	Set básico de impermeabilización	Kerdi-TS Schlüter Systems	
	Cola de pegado	Ultrabond MS Rapid	
	Silicona sellado juntas	Mapesil AC	

Corte a medida

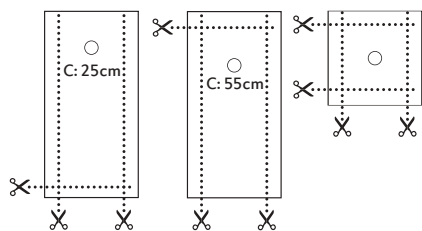

Dimensiones

		A (cm)	B (cm)	C (cm)			A (cm)	B (cm)	C (cm)	
		100	80/90	25			100	100	50	
		120	80/90/100	25						
		140	80/90/100	55						
		160	80/90/100	55						
		180	80/90/100	55						
		200	80/90/100	55						

Ensayos

Textura	Ensayo	Resultado
BETON	UNE-EN 16165:2022 Anexo A	CLASE C
	Normativa francesa XP P 05-010	PN 24

Ficha técnica de producto



Manual de instalación





Prisma Slate

Elegantes ángulos forman parte del plato de ducha Prisma Slate, creando un juego de luces y sombras que aporta valor añadido al diseño del mismo. La textura pizarra toma protagonismo en este plato de ducha a medida, que se corona con una alargada rejilla en formato inoxidable, integrada en sus suaves pendientes.



Dimensiones estándar (cm)

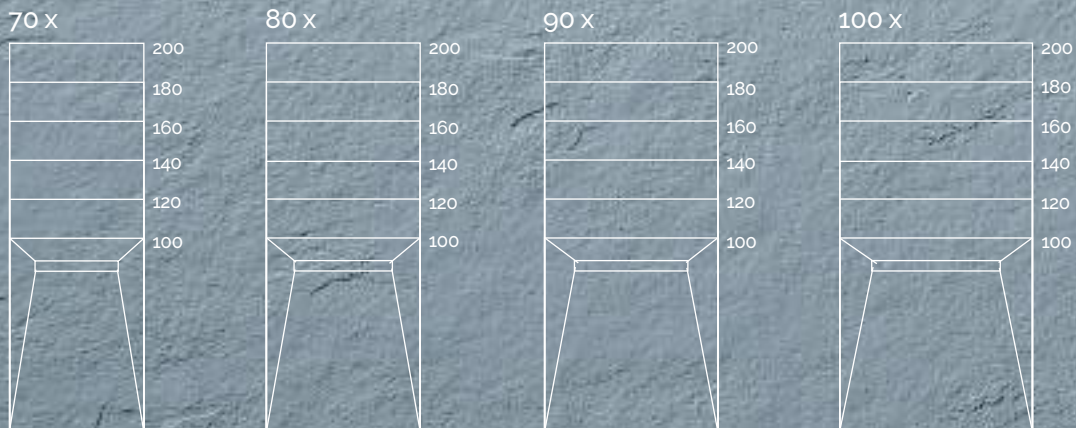



Prisma Slate



Prisma Slate blanco 200x100 cm



Colores

Standard

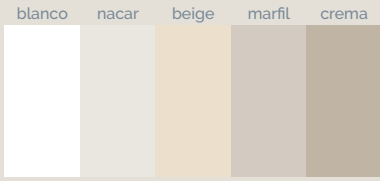

Naturally Made

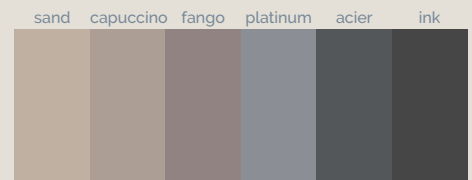

Season

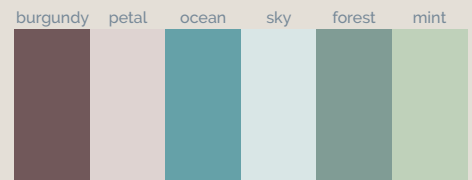

Ra/NCS



PRISMA SLATE COMPLEMENTOS

Rejilla

		Medidas (cm)	Standard	Nat. Made	Season	RaL/NCS
	Rejilla inox	7 x L	<input checked="" type="checkbox"/>	<input checked="" type="checkbox"/>	<input checked="" type="checkbox"/>	<input checked="" type="checkbox"/>

Desagües (mm)

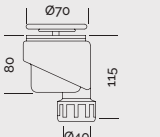
	Desagüe estándar Ø70					<input checked="" type="checkbox"/>
	Desagüe vertical Ø70					<input checked="" type="checkbox"/>

NOTA: incluido un solo modelo de desagüe por plato de ducha.

Moldura

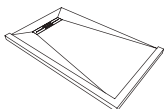
		Textura	Medidas (cm)		
	Moldura	Slate	4,1 x 5	<input type="checkbox"/>	<input type="checkbox"/>

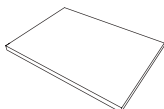

Zona de secado

		Textura	Medidas (cm)	
	Zona de secado	Slate	100 x 100 x 2,3	<input type="checkbox"/>

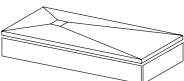
Zócalo de elevación

		Textura	Medidas (cm)	
	Zócalo	Slate	60 - 200 x 9 x 1,6	<input type="checkbox"/>

Materiales para la instalación

	Set básico de impermeabilización	Kerdi-TS Schlüter Systems	<input type="checkbox"/>
	Cola de pegado	Ultrabond MS Rapid	<input type="checkbox"/>
	Silicona sellado juntas	Mapesil AC	<input type="checkbox"/>

Corte a medida

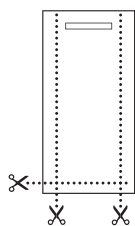

Dimensiones

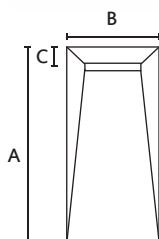
	A (cm)	B (cm)	C (cm)
	100	70/80/90/100	15
	120	70/80/90/100	15
	140	70/80/90/100	25
	160	70/80/90/100	25
	180	70/80/90/100	25
	200	70/80/90/100	25

Ensayos

Textura	Ensayo	Resultado
SLATE	UNE-EN 16165:2022 Anexo A	CLASE C
	Normativa francesa XP P 05-010	PN 24

Ficha técnica de producto



Manual de instalación







Bañeras

Opal Quiz 144-149

Lech 150-153

Nevis 154-157

Dewa 158-161

Voss 162-165

Chrea 166-171

Levi 172-175

Vars 176-179

Venet 180-183

Boreal 184-187

Opal Quiz



Bañera Opal Quiz negro

Colores

Standard



Naturally Made

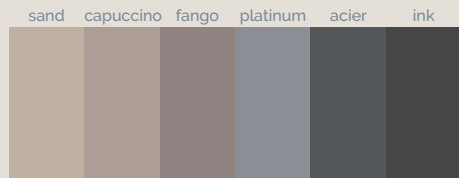

Season

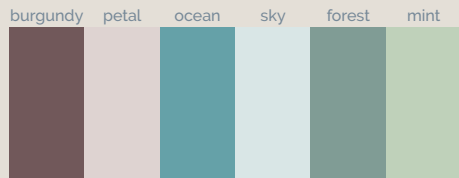

RaI/NCS



Dimensiones estándar (cm)

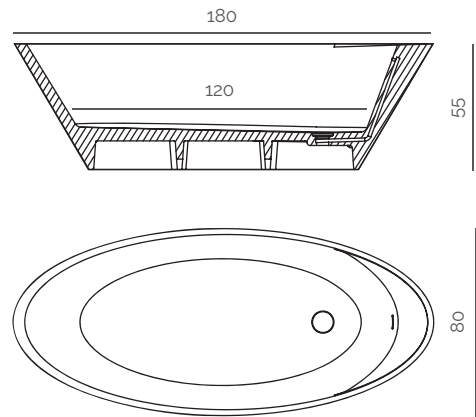

Premios



reddot winner 2021





OPAL QUIZCOMPLEMENTOS

Válvula



Válvula clic-clac Akron

Acabado

Cromo

Acabado tapa

Standard / Nat. Made /
Season / RaI/NCS



Desagüe (mm)

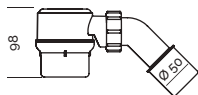

Desagüe estándar H98



Materiales para la instalación



Silicona sellado juntas

Mapesil AC



OPAL QUIZINFORMACIÓN TÉCNICA



Peso de la bañera (Kg)

158



Volumen de agua hasta rebosadero (L)

222

Ficha técnica
de producto



Manual de
instalación









Colores

Standard

blanco mate





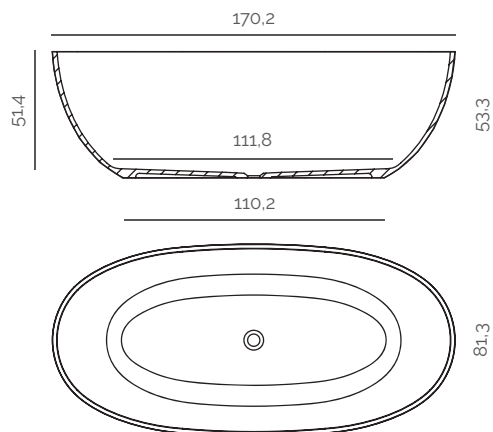

Dimensiones estándar (cm)



LECHCOMPLEMENTOS

Válvula

		Acabado	Acabado tapa	
	Válvula clic-clac	Cromo	Blanco mate	
	Válvula clic-clac	Cromo	Cromo	

Desagüe (mm)

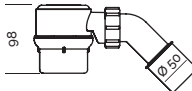
	Desagüe estándar H98			
---	----------------------	--	--	---

Materiales para la instalación

	Silicona sellado juntas	Mapesil AC	
---	-------------------------	------------	---

LECHINFORMACIÓN TÉCNICA

	Peso de la bañera (Kg)	86,54
	Volumen de agua (L)	427

Ficha técnica de producto



Manual de instalación





Nevis



Bañera Nevis

Colores

Standard

blanco mate



Dimensiones estándar (cm)

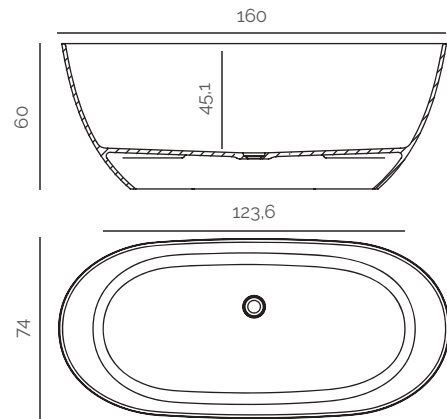

NEVISCOMPLEMENTOS

Válvula



Válvula clic-clac Dolotek

Acabado

Acabado tapa

Cromo

Blanco mate



Desagüe (mm)

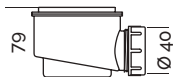

Desagüe estándar H79



Materiales para la instalación



Silicona sellado juntas

Mapesil AC



LECHINFORMACIÓN TÉCNICA



Peso de la bañera (Kg)

94,40



Volumen de agua (L)

375

Ficha técnica
de producto

Manual de
instalación





Dewa



Bañera Dewa



Colores

Standard

blanco mate



Dimensiones estándar (cm)

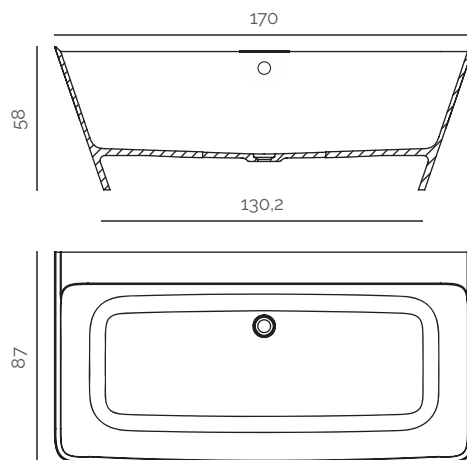

DEWACOMPLEMENTOS

Válvula



Válvula clic-clac Dolotek

Acabado

Acabado tapa

Cromo

Blanco mate



Desagüe (mm)

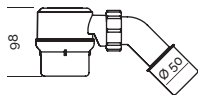

Desagüe estándar H98



Materiales para la instalación



Silicona sellado juntas

Mapesil AC



DEWAINFORMACIÓN TÉCNICA



Peso de la bañera (Kg)

133,11



Volumen de agua hasta rebosadero (L)

263

Ficha técnica
de producto



Manual de
instalación







Colores

Standard

blanco mate



Dimensiones estándar (cm)

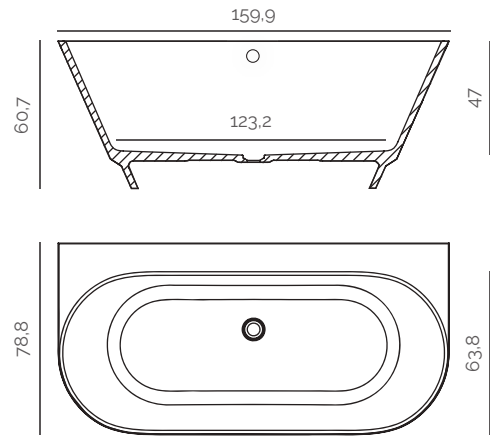

VOSSCOMPLEMENTOS

Válvula



Válvula clic-clac Dolotek

Acabado

Acabado tapa

Cromo

Blanco mate



Desagüe (mm)

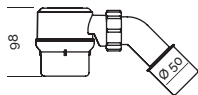

Desagüe estándar H98



Materiales para la instalación



Silicona sellado juntas

Mapesil AC



VOSSINFORMACIÓN TÉCNICA



Peso de la bañera (Kg)

129,45



Volumen de agua hasta rebosadero (L)

246

Ficha técnica
de producto



Manual de
instalación







Colores

Standard

blanco mate



Dimensiones estándar (cm)

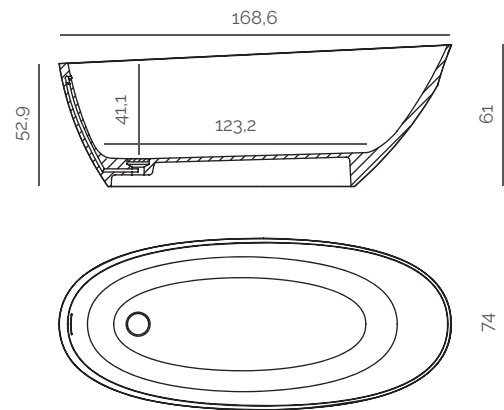





CHREACOMPLEMENTOS

Válvula



Válvula clic-clac Dolotek

Acabado

Acabado tapa

Cromo

Blanco mate



Desagüe (mm)

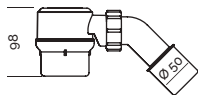

Desagüe estándar H98



Materiales para la instalación



Silicona sellado juntas

Mapesil AC



CHREAINFORMACIÓN TÉCNICA



Peso de la bañera (Kg)

121,40



Volumen de agua hasta rebosadero (L)

226

Ficha técnica
de producto



Manual de
instalación









Colores

Standard

blanco mate





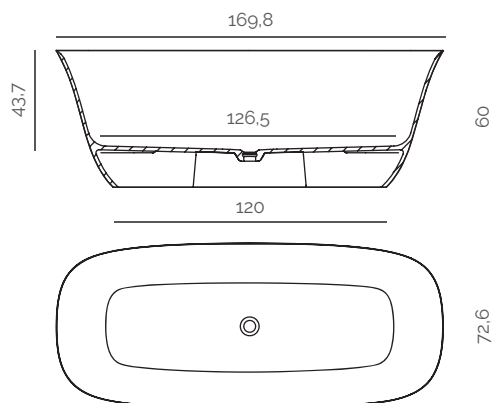

Dimensiones estándar (cm)





LEVICOMPLEMENTOS

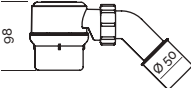

Válvula

		Acabado	Acabado tapa	
	Válvula clic-clac	Cromo	Blanco mate	
	Válvula clic-clac	Cromo	Cromo	

Desagüe (mm)

	Desagüe estándar H98			
---	----------------------	--	--	---

Materiales para la instalación

	Silicona sellado juntas	Mapesil AC	
---	-------------------------	------------	---

LEVIINFORMACIÓN TÉCNICA

	Peso de la bañera (Kg)	121,72
	Volumen de agua (L)	350

Ficha técnica
de producto



Manual de
instalación





Vars



Bañera Vars · Paneles Hera Slate NCS S 0530-Y80R 100x90 cm · Paneles Basic Slate NCS S 0530-Y80R 100x70 cm

Colores

Standard

blanco mate



Dimensiones estándar (cm)

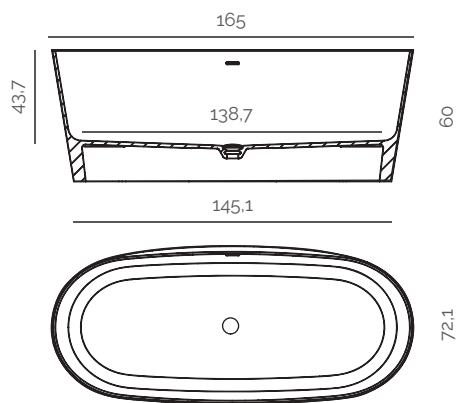

VARSCOMPLEMENTOS

Válvula



Válvula clic-clac Dolotek

Acabado

Acabado tapa

Cromo

Blanco mate



Desagüe (mm)

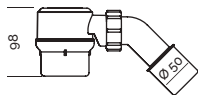

Desagüe estándar H98



Materiales para la instalación



Silicona sellado juntas

Mapesil AC



VARSinFORMACIÓN TÉCNICA



Peso de la bañera (Kg)

110,60



Volumen de agua hasta rebosadero (L)

300

Ficha técnica
de producto



Manual de
instalación





Venet



Bañera Venet



Colores

Standard

blanco mate



Dimensiones estándar (cm)

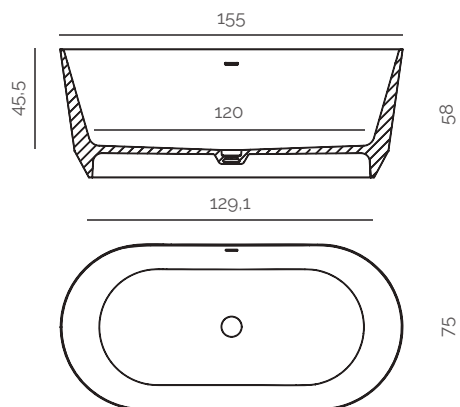

VENETCOMPLEMENTOS

Válvula



Válvula clic-clac Dolotek

Acabado

Acabado tapa

Cromo

Blanco mate



Desagüe (mm)

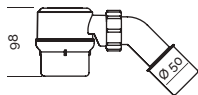

Desagüe estándar H98



Materiales para la instalación



Silicona sellado juntas

Mapesil AC



VENETINFORMACIÓN TÉCNICA



Peso de la bañera (Kg)

192,84



Volumen de agua hasta rebosadero (L)

298

Ficha técnica
de producto



Manual de
instalación





Boreal



Bañera Boreal

Colores

Standard

blanco mate



Dimensiones estándar (cm)

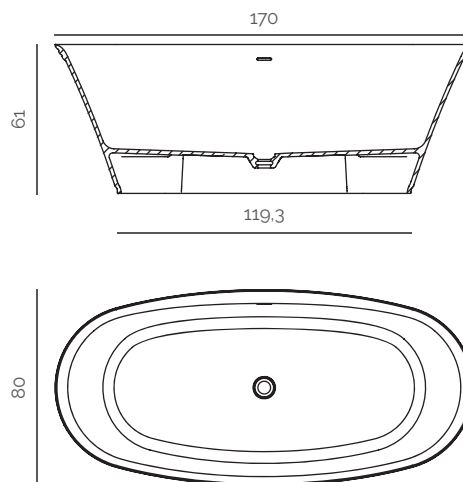

BOREALCOMPLEMENTOS

Válvula



Válvula clic-clac Dolotek

Acabado

Acabado tapa

Cromo

Blanco mate



Desagüe (mm)

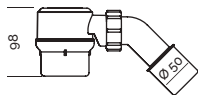

Desagüe estándar H98



Materiales para la instalación



Silicona sellado juntas

Mapesil AC



BOREALINFORMACIÓN TÉCNICA



Peso de la bañera (Kg)

110,50



Volumen de agua hasta rebosadero (L)

290

Ficha técnica
de producto



Manual de
instalación









Paneles

Basic 190-193

Quiz 194-197

Hera 198-201

Muretto Vintage 202-205

Muretto Loft 206-209

Basic



Texturas

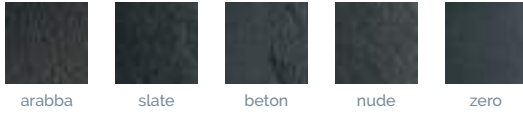

Colores

Standard

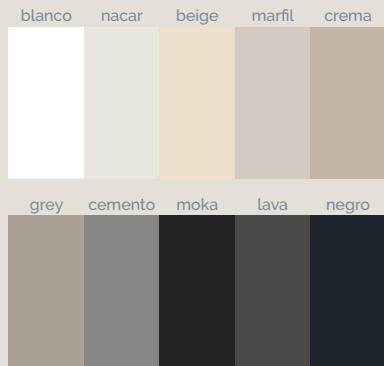

Naturally Made

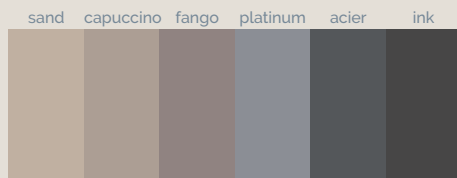

Season

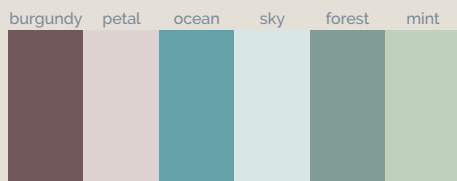

RaL/NCS



Dimensiones estándar (cm)

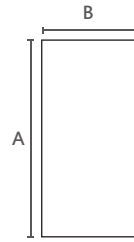





A	B
200	70/80/90/100/120
220	70/80/90/100/120
250	70/80/90/100/120

BASICCOMPLEMENTOS

Perfiles

		Acabado	
	Perfil final	Cromo	
	Perfil de esquina	Cromo	
	Perfil intermedio entre paneles	Cromo	

Materiales para la instalación

	Cola de pegado	Ultrabond MS Rapid	
	Silicona sellado juntas	Mapesil AC	

Ficha técnica
de producto



Manual de
instalación





Quiz



Paneles Quiz blanco 250x120 cm · Encimera One CF Beton crema 240x50 cm · Lavabos On-Top Colors Circle XL Beton NCS S 3050-Y80R · Espejos Moon Beton NCS S 3050-Y80R · Muebles Show 90 Quiz NCS S 3050-Y80R · Armario Show Quiz NCS S 3050-Y80R

Textura



quiz

Colores

Standard

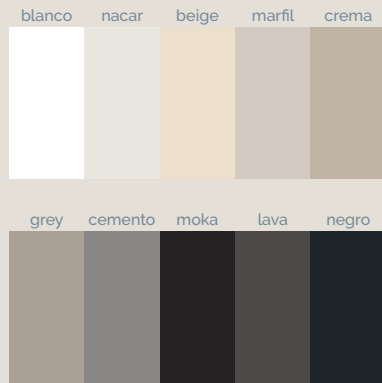

Naturally Made

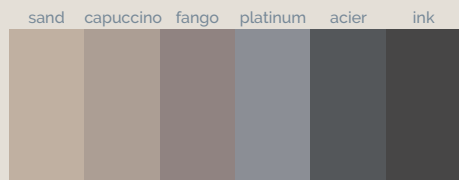

Season

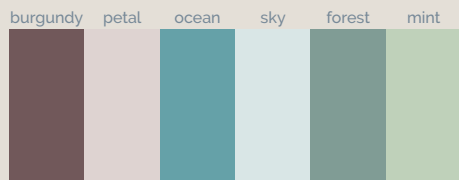

RaI/NCS



Dimensiones estándar (cm)

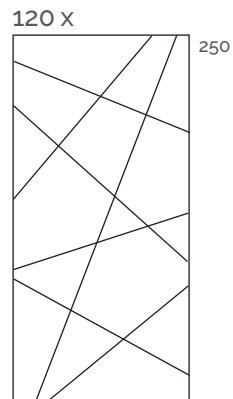





QUIZCOMPLEMENTOS

Perfiles

		Acabado	
	Perfil final	Cromo	
	Perfil de esquina	Cromo	
	Perfil intermedio entre paneles	Cromo	

Materiales para la instalación

	Cola de pegado	Ultrabond MS Rapid	
	Silicona sellado juntas	Mapesil AC	

QUIZINFORMACIÓN TÉCNICA

Instalación

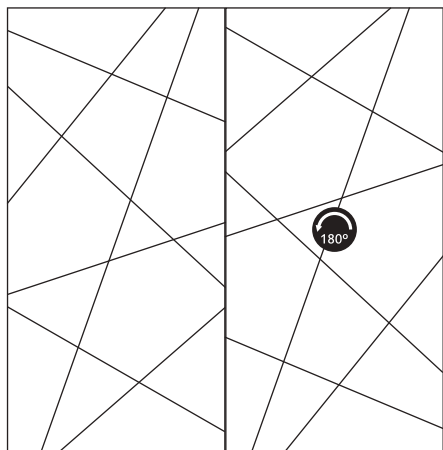

Ficha técnica de producto



Manual de instalación





Hera



Paneles Hera Zero capuccino 250x100 cm

Textura



zero

Colores

Standard

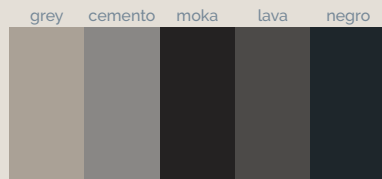
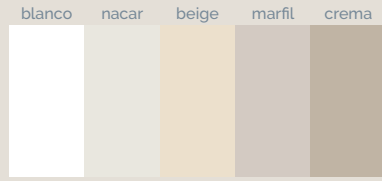

Naturally Made

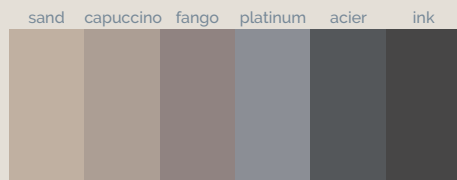

Season

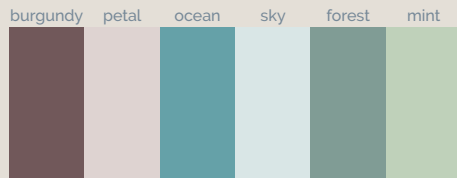

RaI/NCS



Dimensiones estándar (cm)

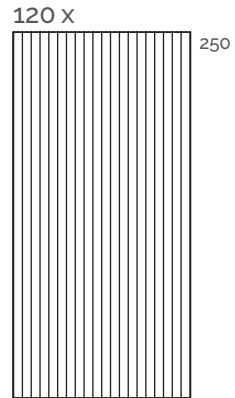

HERACOMPLEMENTOS

Materiales para la instalación



Cola de pegado

Ultrabond MS Rapid

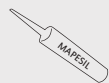

Silicona sellado juntas

Mapesil AC



HERAINFORMACIÓN TÉCNICA

Instalación

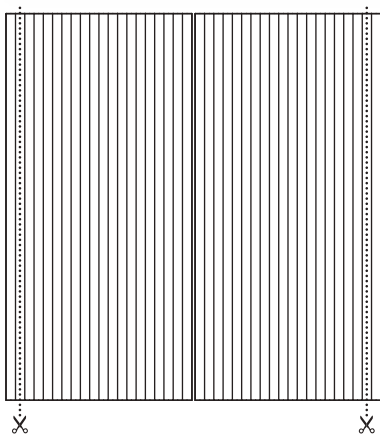

Ficha técnica
de producto



Manual de
instalación





Muretto Vintage





Colores

Standard



Naturally Made

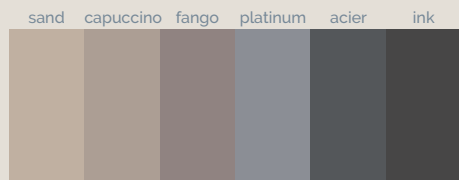

Season

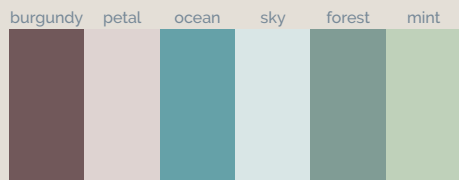

RaI/NCS



Dimensiones estándar (cm)

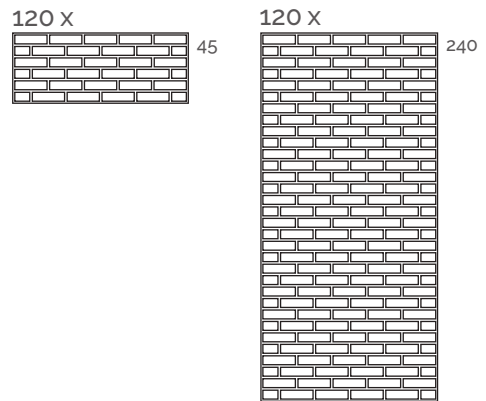

MURETTO VINTAGE COMPLEMENTOS

Materiales para la instalación



Cola de pegado

Ultrabond MS Rapid



Silicona sellado juntas

Mapesil AC



MURETTO VINTAGE INFORMACIÓN TÉCNICA

Instalación

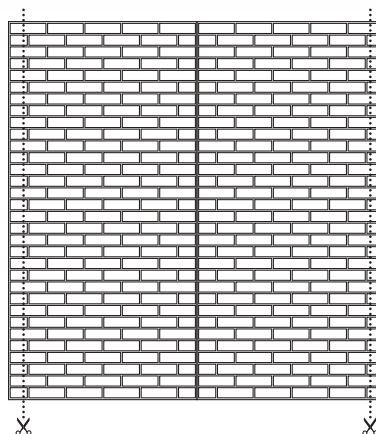
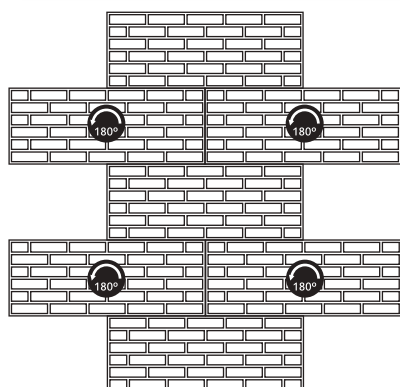

Ficha técnica
de producto

Manual de
instalación





Muretto Loft



Muretto Loft XL NCS S 4030-Y80R 250x120 cm

Textura



beton

Colores

Standard

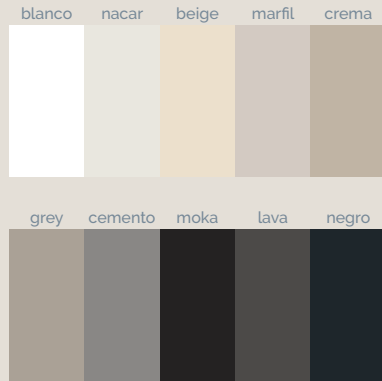

Naturally Made

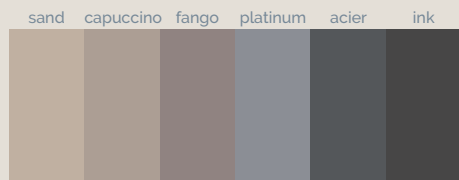

Season

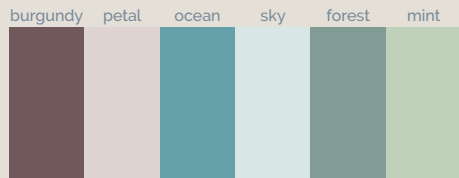

RaL/NCS



Dimensiones estándar (cm)

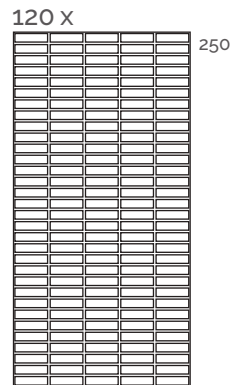

MURETTO LOFTCOMPLEMENTOS

Materiales para la instalación



Cola de pegado

Ultrabond MS Rapid

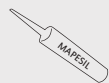

Silicona sellado juntas

Mapesil AC



MURETTO LOFTINFORMACIÓN TÉCNICA

Instalación

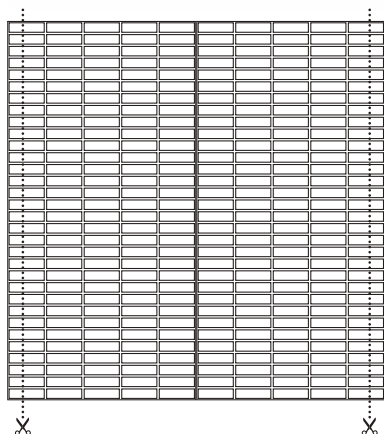

Ficha técnica
de producto



Manual de
instalación









Encimeras

Integra 212-217

Integra 2 218-221

Mini 222-225

Infinity 226-229

Infinity 2 230-235

One 236-239

Moiwa 240-243

Integra



Encimera Integra CF 120 DX Slate NCS S 3030-Y80R



slate

Colores

Standard

blanco nacar beige marfil crema

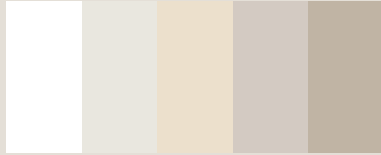

grey cemento moka lava negro

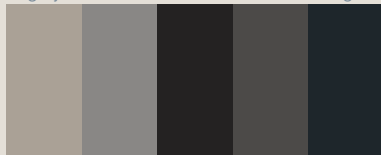

Naturally Made

sand capuccino fango platinum acier ink



Season

burgundy petal ocean sky forest mint

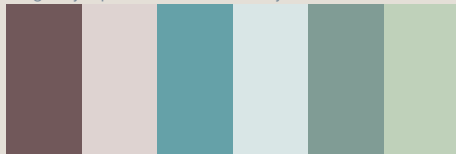

Ral/NCS



Dimensiones estándar (cm)

Integra 60

SF: 60,3 / CF: 60

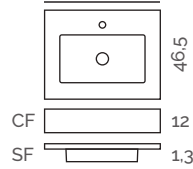

Integra 80

SF: 80,3 / CF: 80

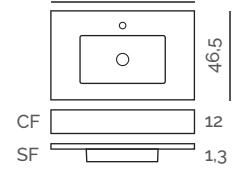

Integra 90

SF: 90,3 / CF: 90

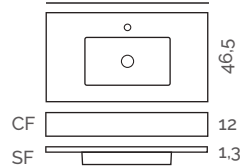

Integra 100

SF: 100,3 / CF: 100

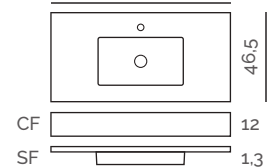

Integra 100 Sx

SF: 100,3 / CF: 100

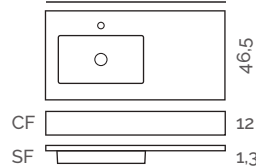

Integra 100 Dx

SF: 100,3 / CF: 100

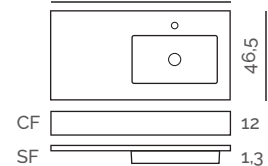

Integra 120

SF: 120,3 / CF: 120

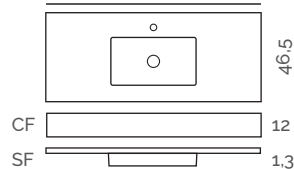

Integra 120 Sx

SF: 120,3 / CF: 120

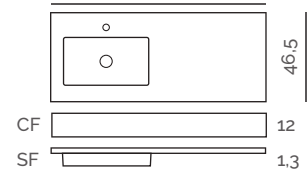

Integra 120 Dx

SF: 120,3 / CF: 120

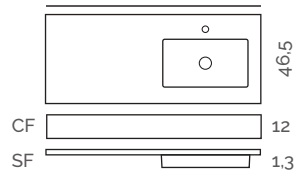

Integra 120 XL

SF: 120,3 / CF: 120

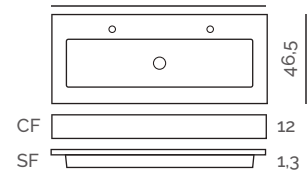











INTEGRACOMPLEMENTOS



Lavabos

	Medidas (cm)	Integra 60	Integra 80	Integra 90	Integra 100	Integra 120	Integra 120 XL
	26,7 x 50 x 9	✓	✓	✓	✓	✓	
	26,7 x 104 x 9						✓



Válvulas

		Acabado	
	Válvula clic-clac Akron	Cromo / Negro	
	Válvula de salida libre Akron	Cromo / Negro	

Copete

		Textura	Medidas (cm)	
	Copete	Slate	60 - 120 x 3 x 1,6	

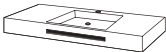



Toalleros

		Medidas (cm)	Integra CF
	Toallero Show frontal	40 x 4	

Sistema de fijación

		Integra SF	Integra CF
	Sistema de fijación		✓

Materiales para la instalación

	Cola de pegado	Ultrabond MS Rapid	
	Silicona sellado juntas	Mapesil AC	

Ficha técnica de producto



Manual de instalación





Integra 2



Encimera Integra 2 CF 140 Slate capuccino · Paneles Basic Slate blanco 250x100 cm · Espejo Urban

Textura



slate

Colores

Standard

blanco nacar beige marfil crema



grey cemento moka lava negro



Naturally Made

sand capuccino fango platinum acier ink



Season

burgundy petal ocean sky forest mint

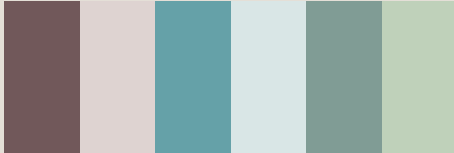

RaI/NCS



Dimensiones estándar (cm)

Integra-2 120

SF: 120,3 / CF: 120

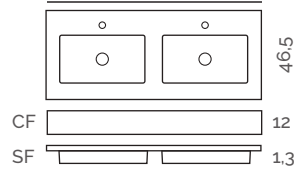

Integra-2 140

SF: 140,3 / CF: 140

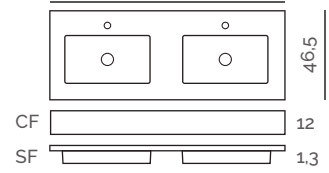

INTEGRA 2 COMPLEMENTOS

Lavabos

	Medidas (cm)	Integra-2 120	Integra-2 140
	26,7 x 50 x 9	<input checked="" type="checkbox"/>	<input checked="" type="checkbox"/>

Válvulas

		Acabado	
	Válvula clic-clac Akron	Cromo / Negro	<input type="checkbox"/>
	Válvula de salida libre Akron	Cromo / Negro	<input type="checkbox"/>

Copete

		Textura	Medidas (cm)	
	Copete	Slate	120 - 140 x 3 x 1,6	<input type="checkbox"/>

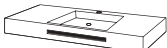

Toalleros

		Medidas (cm)	Integra-2 CF
	Toallero Show frontal	40 x 4	<input type="checkbox"/>

Sistema de fijación

		Integra-2 SF	Integra-2 CF
	Sistema de fijación		<input checked="" type="checkbox"/>

Materiales para la instalación

	Cola de pegado	Ultrabond MS Rapid	<input type="checkbox"/>
	Silicona sellado juntas	Mapesil AC	<input type="checkbox"/>

Ficha técnica de producto



Manual de instalación





Mini



Encimeras Mini Slate blanco · Panel Basic Slate NCS S 4020-R90B 250x120 cm · Espejo Urban

Textura



slate

Colores

Standard

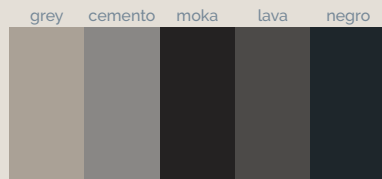
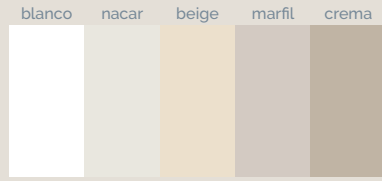

Naturally Made

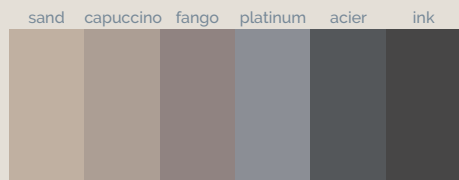

Season

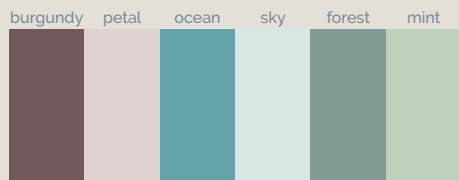

RaI/NCS



Dimensiones estándar (cm)

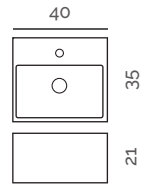

MINICOMPLEMENTOS



Lavabos

	Medidas (cm)		
	23,4 x 38 x 12,1		



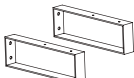

Válvulas

		Acabado	
	Válvula clic-clac Akron	Cromo / Negro	
	Válvula de salida libre Akron	Cromo / Negro	

Sistema de fijación

		Acabado	
	Sistema de fijación	Acero pulido / Negro	

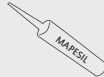
Materiales para la instalación

	Cola de pegado	Ultrabond MS Rapid	
	Silicona sellado juntas	Mapesil AC	

Ficha técnica de producto



Manual de instalación





Infinity



Encimera Infinity 52 CF Arabba capuccino 200x50 cm

Texturas

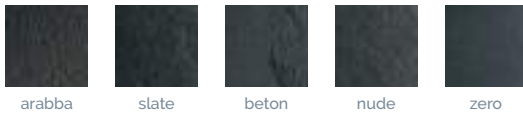

Colores

Standard

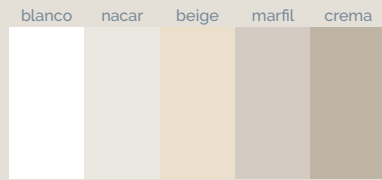

Naturally Made

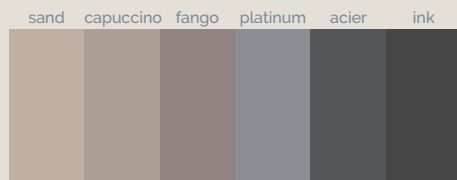

Season

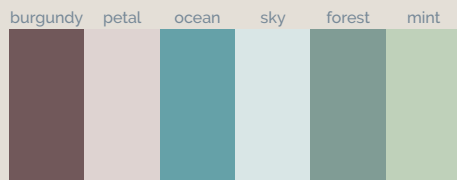

RaI/NCS



Dimensiones estándar (cm)

Infinity 42

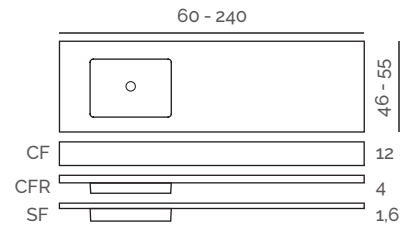

Infinity 52

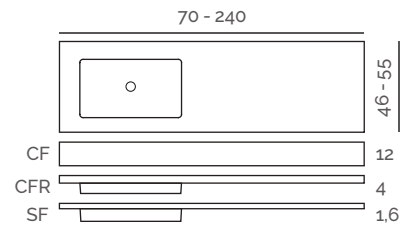

Infinity Round 52

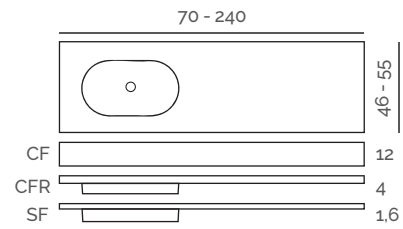

Infinity 62

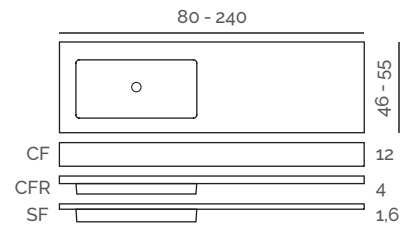





NOTA: es necesario añadir el diseño de la encimera con todas las medidas en cada pedido.

Ficha solicitud
pedido







INFINITYCOMPLEMENTOS



Lavabos

		Medidas (cm)	Tamaño encimera	Infinity 42	Infinity 52	Infinity 62
	Lavabo 42	30 x 42 x 10	Infinity 60 - 240	✓		
	Lavabo 52	30 x 52 x 10	Infinity 70 - 240		✓	
	Lavabo 52 Round	30 x 52 x 10	Infinity 70 - 240		✓	
	Lavabo 62	30 x 62 x 10	Infinity 80 - 240			✓







Válvulas

		Acabado	
	Válvula clic-clac Akron	Cromo / Negro	
	Válvula de salida libre Akron	Cromo / Negro	

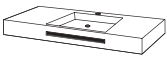
Copete

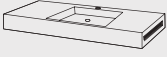
		Textura	Medidas (cm)	
	Copete	Arabba / Slate / Beton / Nude / Zero	60 - 240 x 3 x 1,6	

Toalleros

		Medidas (cm)	Infinity CF
	Toallero Show frontal	40 x 4	
	Toallero Show derecho	40 x 4	
	Toallero Show izquierdo	40 x 4	

Sistema de fijación

		Infinity CF	Infinity CFR	Infinity SF
	Sistema de fijación	✓	✓	

Ficha técnica de producto



Manual de instalación



Materiales para la instalación



Cola de pegado

Ultrabond MS Rapid



Silicona sellado juntas

Mapesil AC



Encimeras

Infinity 2



Encimera Infinity 2 Round 52 CF Beton platinum 220x46 cm

Texturas



Colores

Standard

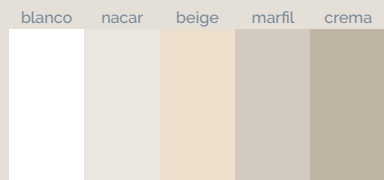

Naturally Made

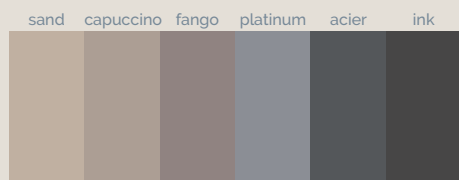

Season

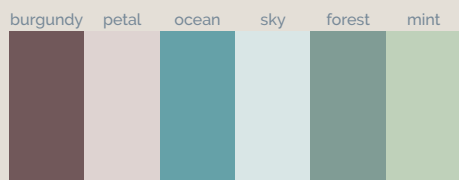

RaL/NCS



Dimensiones estándar (cm)

Infinity-2 42

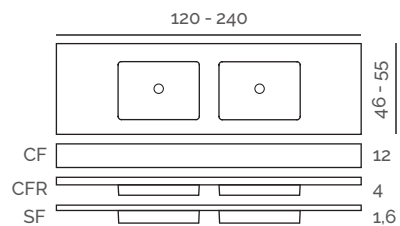

Infinity-2 52

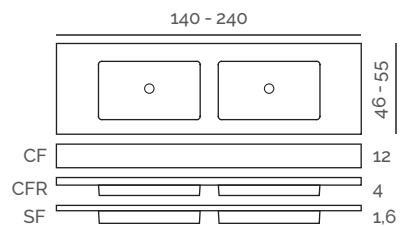

Infinity-2 Round 52

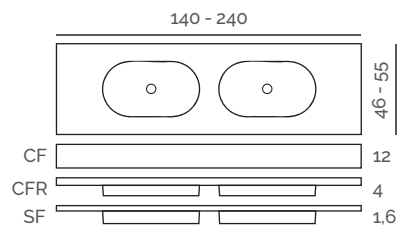

Infinity-2 62

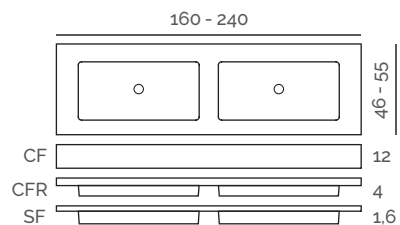

NOTA: es necesario añadir el diseño de la encimera con todas las medidas en cada pedido.

Ficha solicitud
pedido











INFINITY 2 COMPLEMENTOS



Lavabos

		Medidas (cm)	Tamaño encimera	Infinity-2 42	Infinity-2 52	Infinity-2 62
	Lavabo 42	30 x 42 x 10	Infinity-2 120 - 240	✓		
	Lavabo 52	30 x 52 x 10	Infinity-2 140 - 240		✓	
	Lavabo 52 Round	30 x 52 x 10	Infinity-2 140 - 240		✓	
	Lavabo 62	30 x 62 x 10	Infinity-2 160 - 240			✓







Válvulas

		Acabado	
	Válvula clic-clac Akron	Cromo / Negro	
	Válvula de salida libre Akron	Cromo / Negro	

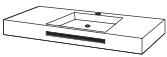
Copete

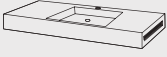
		Textura	Medidas (cm)	
	Copete	Arabba / Slate / Beton / Nude / Zero	120 - 240 x 3 x 1,6	

Toalleros

		Medidas (cm)	Infinity-2 CF
	Toallero Show frontal	40 x 4	
	Toallero Show derecho	40 x 4	
	Toallero Show izquierdo	40 x 4	

Sistema de fijación

		Infinity-2 CF	Infinity-2 CFR	Infinity-2 SF
	Sistema de fijación	✓	✓	

Ficha técnica de producto



Manual de instalación



Materiales para la instalación



Cola de pegado

Ultrabond MS Rapid



Silicona sellado juntas

Mapesil AC



Encimeras

One



Encimera One CF Beton sky 180x50 cm

Texturas

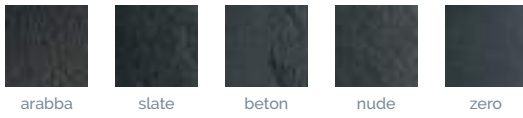

Colores

Standard

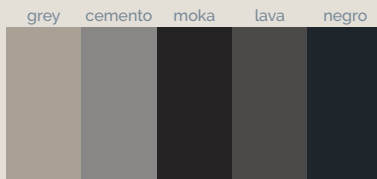
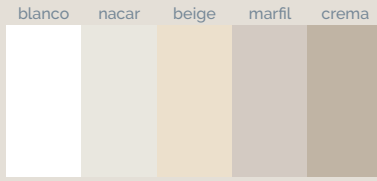

Naturally Made

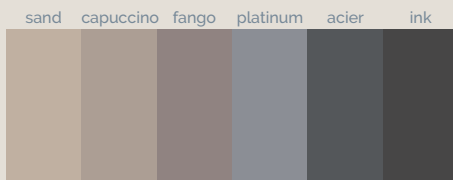

Season

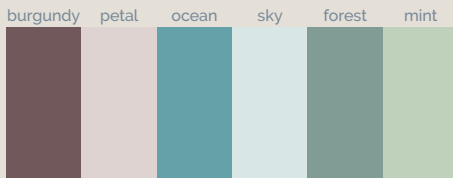

RaL/NCS



Dimensiones estándar (cm)

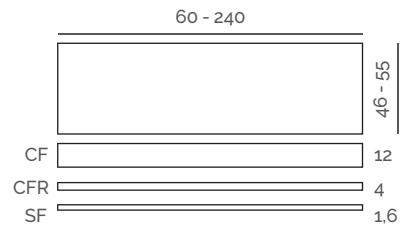



NOTA: es necesario añadir el diseño de la encimera con todas las medidas en cada pedido.

Ficha solicitud
pedido







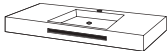

ONECOMPLEMENTOS

Copete

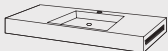
	Textura	Medidas (cm)	
 Copete	Arabba / Slate / Beton / Nude / Zero	60 - 240 x 3 x 1,6	

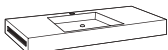



Toalleros

	Medidas (cm)	
 Toallero Show frontal	40 x 4	One CF 
 Toallero Show derecho	40 x 4	
 Toallero Show izquierdo	40 x 4	

Sistema de fijación

 Sistema de fijación	One CF 	One CFR 	One SF
---	--	---	--------

Materiales para la instalación

 Cola de pegado	Ultrabond MS Rapid	
 Silicona sellado juntas	Mapesil AC	

Ficha técnica
de producto



Manual de
instalación





Encimeras



Colores

Standard

blanco mate



Dimensiones estándar (cm)

Moiwa 81

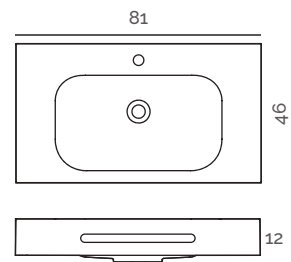

Moiwa 91

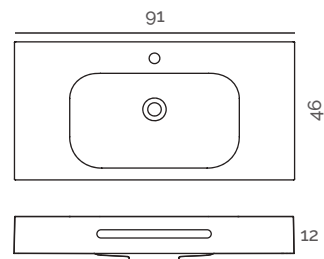

Moiwa 101

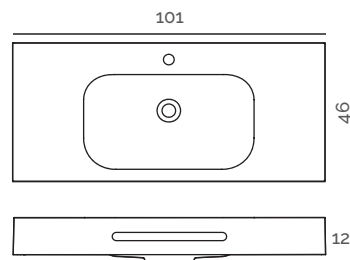

Moiwa 121

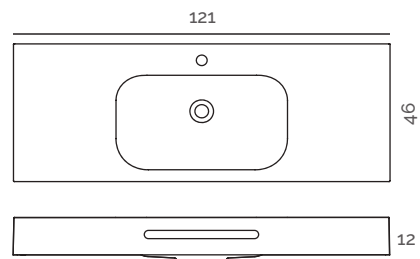



MOIWA COMPLEMENTOS

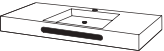

Válvulas

		Acabado	Acabado tapa	
	Válvula clic-clac	Cromo	Cromo	
	Válvula de salida libre	Cromo	Cromo	
	Válvula Pop Down	Cromo	Cromo	
	Válvula Plana	Cromo	Cromo	

Toalleros

		Medidas (cm)	
	Toallero Moiwa	50 x 5	

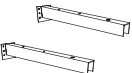
Sistema de fijación

	Sistema de fijación		
---	---------------------	--	---

Materiales para la instalación

	Silicona sellado juntas	Mapesil AC	
---	-------------------------	------------	---

Ficha técnica
de producto



Manual de
instalación









Lavabos

Delia 246-249

On-Top 250-255

Chrea 256-259

Levi 260-263

Vars 264-267

Venet 268-271

Delia



Lavabo Delia Zero forest

Textura



zero

Colores

Standard

blanco nacar beige marfil crema

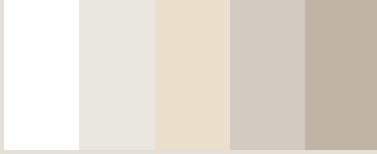

grey cemento moka lava negro

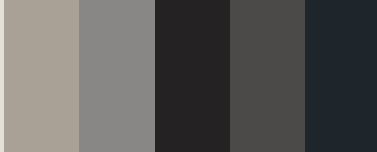

Naturally Made

sand capuccino fango platinum acier ink



Season

burgundy petal ocean sky forest mint

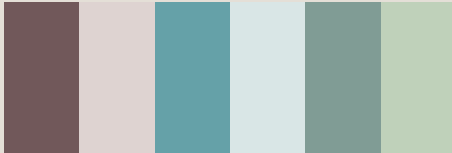

RaI/NCS



Dimensiones estándar (cm)

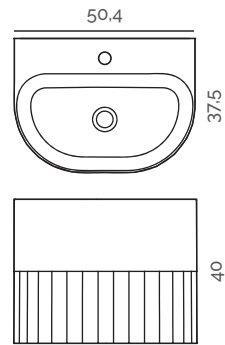

Lavabos

Premio



archiproducts
DESIGN AWARDS
2022

WINNER

DELIACOMPLEMENTOS

Válvulas

		Acabado	
	Válvula clic-clac Akron	Cromo / Negro	
	Válvula de salida libre Akron	Cromo / Negro	

Sistema de fijación

	Sistema de fijación		
---	---------------------	--	---

Materiales para la instalación

	Silicona sellado juntas	Mapesil AC	
---	-------------------------	------------	---

Ficha técnica de producto



Manual de instalación





On-Top



Lavabos On-top Rectangle XL Beton NCS S 3040-Y60R

Texturas

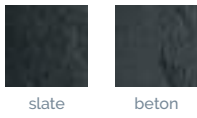

Colores

Standard

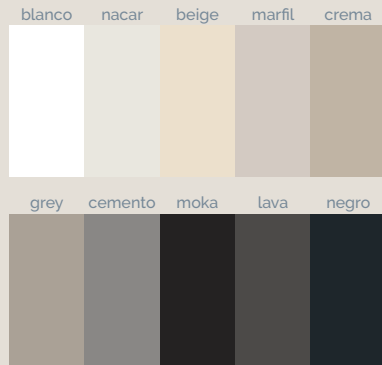

Naturally Made

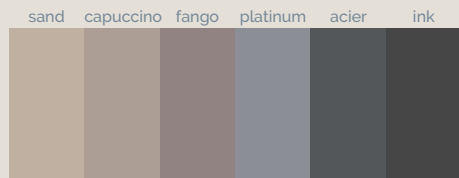

Season

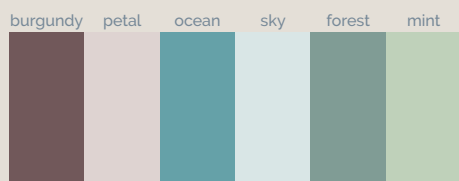

RaL/NCS



Dimensiones estándar (cm)

On-Top Circle

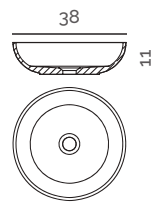

On-Top Circle XL

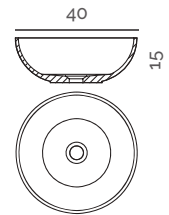

On-Top Square

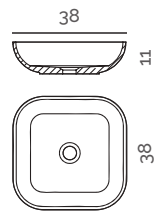

On-Top Square XL

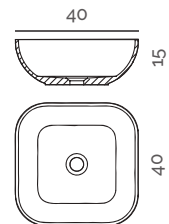

On-Top Oval

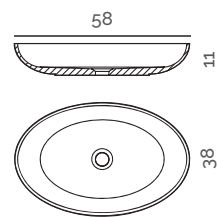

On-Top Oval XL

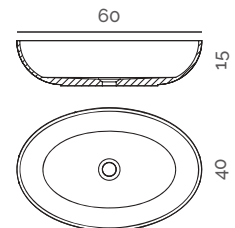

On-Top Rectangle

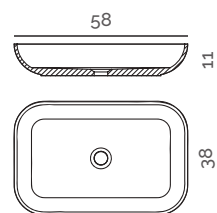

On-Top Rectangle XL

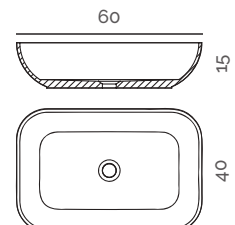

NOTA: desagüe de 5 cm de diámetro.





ON-TOP COMPLEMENTOS

Válvulas

		Acabado	
	Válvula clic-clac Akron	Cromo / Negro	
	Válvula de salida libre Akron	Cromo / Negro	

Materiales para la instalación



Silicona sellado juntas

Mapesil AC



Ficha técnica de producto



Manual de instalación





Chrea



Lavabo Chrea



Colores

Standard

blanco mate



Dimensiones estándar (cm)

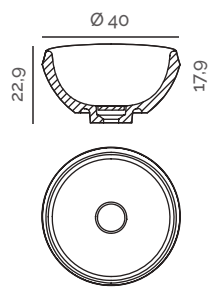

CHREACOMPLEMENTOS

Válvula



Válvula clic-clac Dolotek

Acabado

Acabado tapa

Cromo

Blanco mate



Materiales para la instalación



Silicona sellado juntas

Mapesil AC



Ficha técnica
de producto



Manual de
instalación







Lavabo Levi Rectangle

Colores

Standard

blanco mate



Dimensiones estándar (cm)

Levi Circle XL

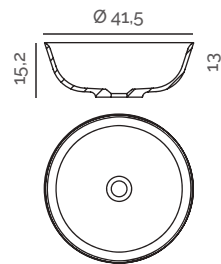

Levi Rectangle

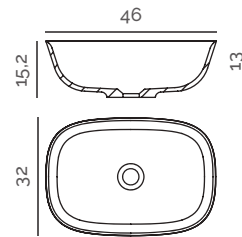

Levi Rectangle XL

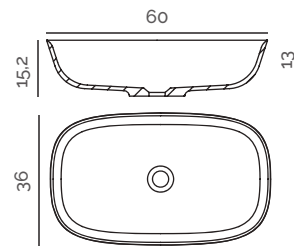

LEVICOMPLEMENTOS

Válvulas

		Acabado	Acabado tapa	
	Válvula clic-clac	Cromo	Cromo	
	Válvula de salida libre	Cromo	Cromo	
	Válvula Pop Down	Cromo	Cromo	
	Válvula Plana	Cromo	Cromo	

Materiales para la instalación



Silicona sellado juntas

Mapesil AC



Ficha técnica
de producto



Manual de
instalación





Lavabos

Vars



Lavabo Vars Rectangle XL

Colores

Standard

blanco mate



Dimensiones estándar (cm)

Vars Circle

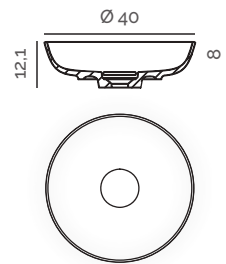

Vars Circle XL

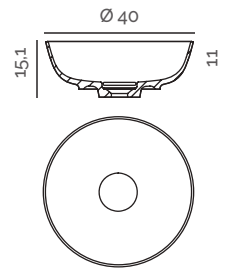

Vars Square XL

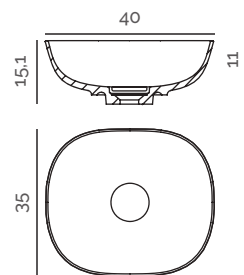

Vars Rectangle XL

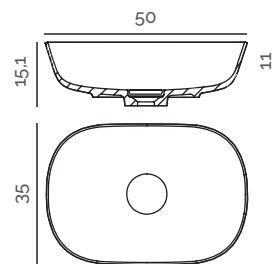

VARSCOMPLEMENTOS

Tapa



Tapa Dolotek

Material

Dolotek

Acabado

Blanco mate



Válvulas



Válvula Pop Down

Acabado

Cromo

Acabado tapa

Cromo



Válvula Plana

Cromo

Cromo



Materiales para la instalación



Silicona sellado juntas

Mapesil AC



Ficha técnica
de producto



Manual de
instalación







Colores

Standard

blanco mate



Dimensiones estándar (cm)

Venet Circle

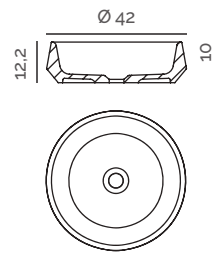

Venet Circle XL

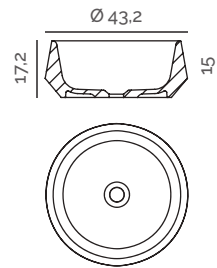

Venet Square

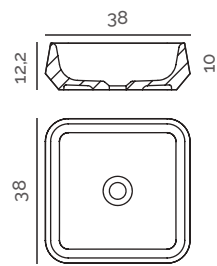

Venet Rectangle

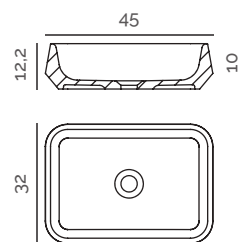

VENETCOMPLEMENTOS

Válvulas

		Acabado	Acabado tapa	
	Válvula clic-clac	Cromo	Cromo	
	Válvula de salida libre	Cromo	Cromo	
	Válvula Pop Down	Cromo	Cromo	
	Válvula Plana	Cromo	Cromo	

Materiales para la instalación



Silicona sellado juntas

Mapesil AC



Ficha técnica de producto



Manual de instalación









Tótems

Icon 274-277

Levi 278-281

Vars 282-285



Textura



slate

Colores

Standard

blanco nacar beige marfil crema

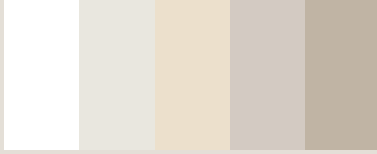

grey cemento moka lava negro



Naturally Made

sand capuccino fango platinum acier ink



Season

burgundy petal ocean sky forest mint

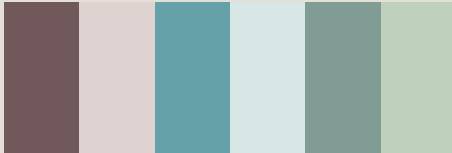

RaI/NCS



Dimensiones estándar (cm)

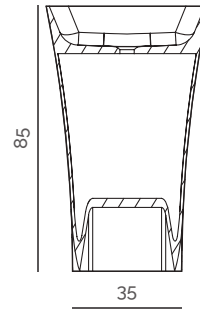
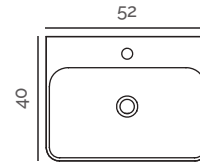

ICONCOMPLEMENTOS

Válvulas

		Acabado	
	Válvula clic-clac Akron	Cromo / Negro	
	Válvula de salida libre Akron	Cromo / Negro	

Sistema de fijación

	Sistema de fijación	
---	---------------------	---

Materiales para la instalación

	Silicona sellado juntas	Mapesil AC	
---	-------------------------	------------	---

Ficha técnica de producto



Manual de instalación









Colores

Standard

blanco mate



Dimensiones estándar (cm)

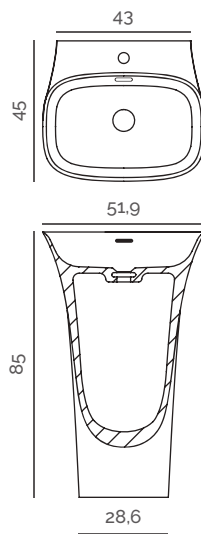

LEVICOMPLEMENTOS

Válvulas



Válvula clic-clac con rebosadero

Acabado

Cromo

Acabado tapa

Cromo



Sistema de fijación



Sistema de fijación



Materiales para la instalación



Silicona sellado juntas

Mapesil AC



Ficha técnica
de producto



Manual de
instalación







Colores

Standard

blanco mate



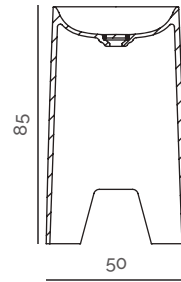
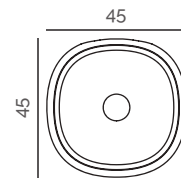

Dimensiones estándar (cm)







VARSCOMPLEMENTOS

Tapa

		Material	Acabado	
	Tapa Dolotek	Dolotek	Blanco mate	

Válvulas

		Acabado	Acabado tapa	
	Válvula Pop Down	Cromo	Cromo	
	Válvula Plana	Cromo	Cromo	

Materiales para la instalación

	Silicona sellado juntas	Mapesil AC	
---	-------------------------	------------	---

Ficha técnica de producto



Manual de instalación







Muebles y accesorios

<i>Mueble Artic</i>	288-291
<i>Mueble Delia</i>	292-293
<i>Mueble Integra</i>	294-295
<i>Mueble Integra a suelo</i>	296-297
<i>Mueble Urban</i>	298-299
<i>Mueble Show</i>	300-301
<i>Armario Show</i>	302-303
<i>Taburete Show</i>	304-305
<i>Asiento a pared Show</i>	306-307
<i>Estante Box</i>	308-309
<i>Estante Show</i>	310-311
<i>Estante Corner Show</i>	312-313
<i>Mueble Bastidor WC</i>	314-315
<i>Espejo Moon</i>	316-317
<i>Espejo Urban</i>	318-319
<i>Espejo Show</i>	320-321
<i>Columna de ducha Kendo</i>	322-323

Mueble Artic



Acabados

madera blanco

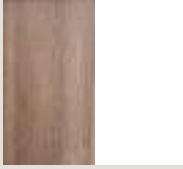

Dimensiones estándar (cm)

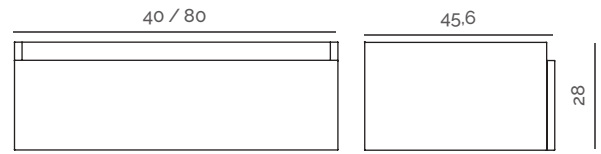

NOTA: el Mueble Artic no incluye encimera.

NOTA: el Mueble Artic puede ir acompañado de cualquiera de nuestras encimeras con posición de desagüe centrado. Las encimeras Infinity e Infinity 2 deben ir sin agujero de grifería.

Ficha técnica
de producto



Manual de
instalación







Mueble Delia



Muebles Delia Slate capuccino · Lavabos Delia Zero capuccino

Texturas

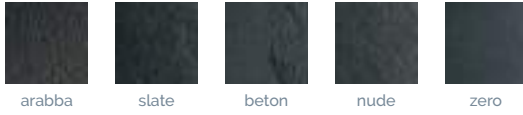

Colores

Standard

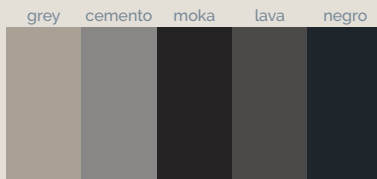
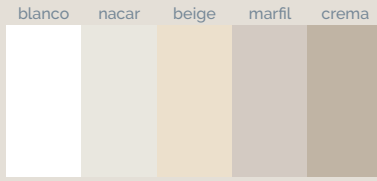

Naturally Made

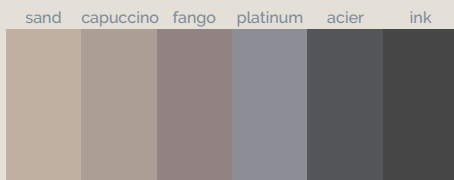

Season

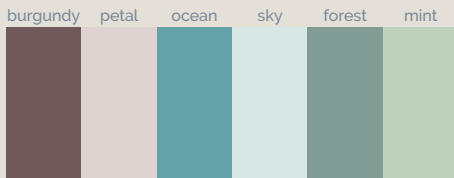

RaI/NCS



Dimensiones estándar (cm)

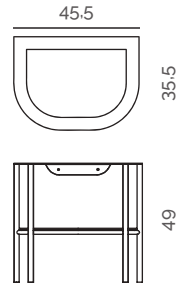

NOTA: lavabo Delia no incluido con el Mueble Delia.

Ficha técnica
de producto



Manual de
instalación



Mueble Integra



Texturas

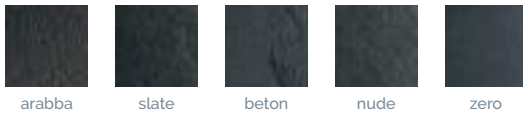

Colores

Standard

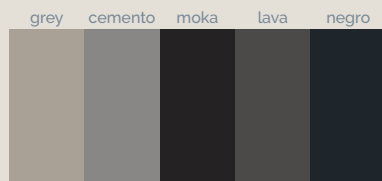
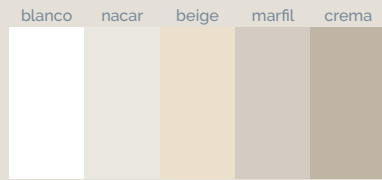

Naturally Made

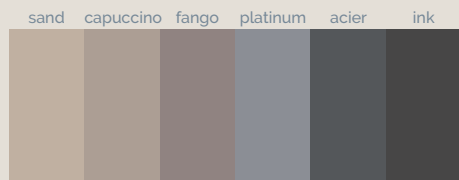

Season

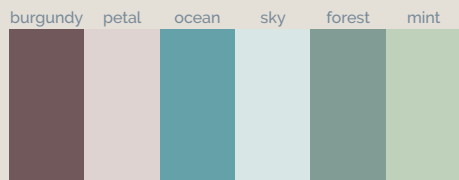

RaI/NCS



Dimensiones estándar (cm)

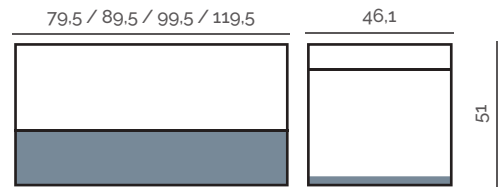

NOTA: el Mueble Integra no incluye encimera.

Ficha técnica
de producto



Manual de
instalación



Mueble Integra a suelo



Mueble Integra a suelo 120 Slate lava · Encimera Integra SF 120 SX Slate lava · Espejo Urban

Texturas

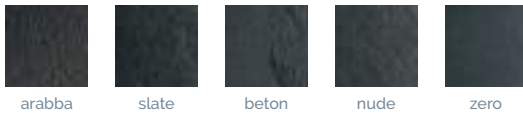

Colores

Standard

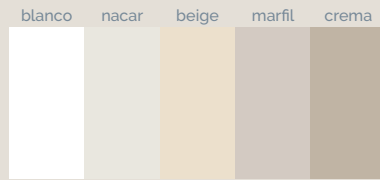

Naturally Made

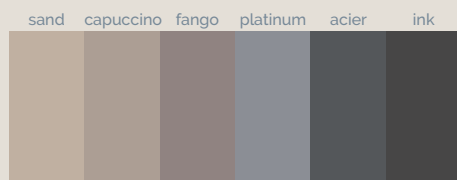

Season

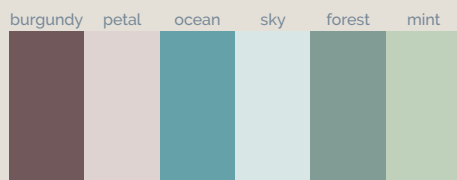

RaI/NCS



Dimensiones estándar (cm)

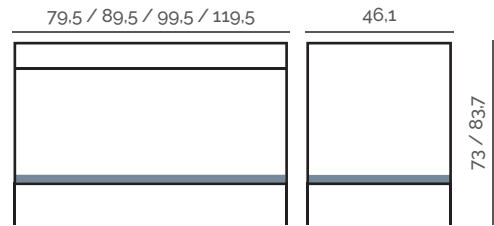

NOTA: el Mueble Integra a suelo no incluye encimera.

Altura (cm)

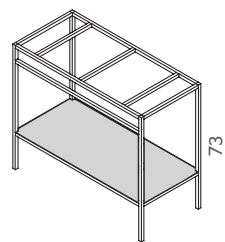

Integra CF

Integra 2 CF

Infinity CF

Infinity 2 CF

One CF

One CFR

One SF

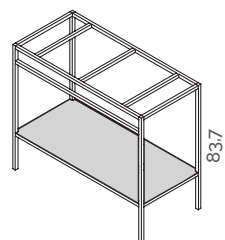

Integra SF

Integra 2 SF

Infinity CFR

Infinity SF

Infinity 2 CFR

Infinity 2 SF

Ficha técnica
de producto



Manual de
instalación



Mueble Urban



Mueble Urban madera 100 cm · Encimera One SF Beton NCS S 3020-G10Y · Lavabo On-Top Circle XL Beton crema · Paneles Quiz NCS S 5020-B90G 240X120 cm · Espejo Urban

Acabados

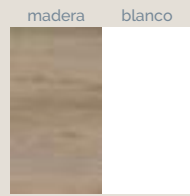

Dimensiones estándar (cm)

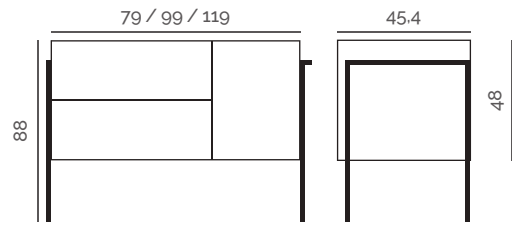

NOTA: el Mueble Urban no incluye encimera.

NOTA: el Mueble Urban puede ir acompañado de cualquiera de nuestras encimeras siempre que se ajuste a los siguientes parámetros: largo 80, 100 ó 120 cm - ancho 46 cm - posición del desagüe centrado.

Ficha técnica
de producto



Manual de
instalación





Texturas

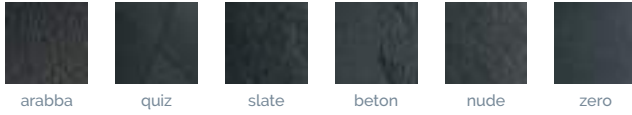

Colores

Standard



Naturally Made

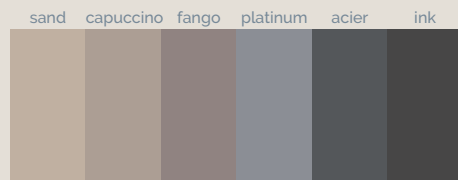

Season

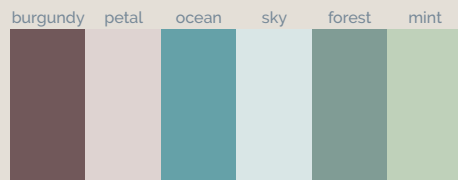

RaL/NCS



Dimensiones estándar (cm)

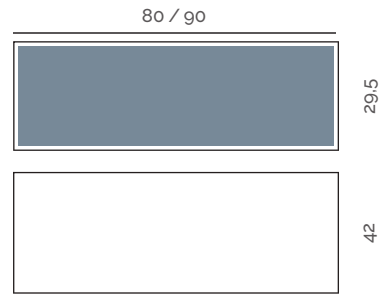

Ficha técnica
de producto



Manual de
instalación



Armario Show



Armario Show Quiz NCS S 3050-Y80R

Texturas

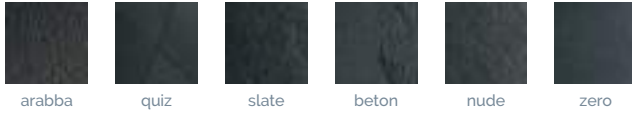

Colores

Standard

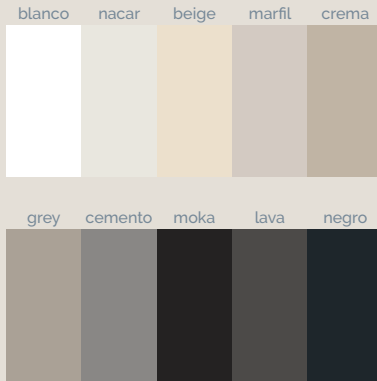

Naturally Made

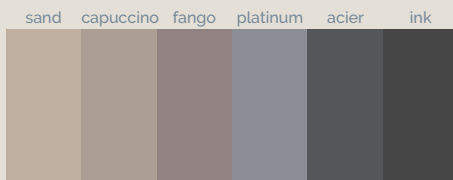

Season

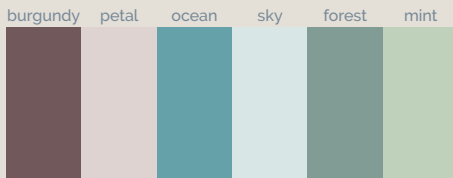

RaL/NCS



Dimensiones estándar (cm)

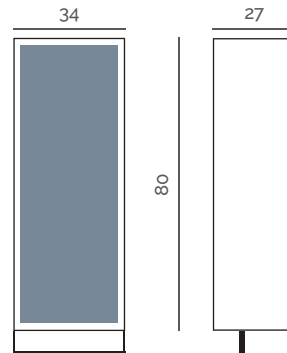

Ficha técnica de producto



Manual de instalación



Taburete Show



Taburete Show blanco Slate NCS S 5540-Rg0B · Bañera Chrea · Panel Hera Zero NCS S 2050-Y 220x100 cm

Texturas

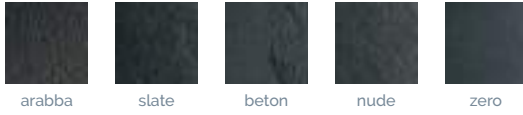

Colores

Standard

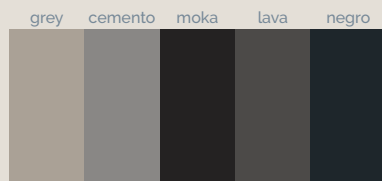
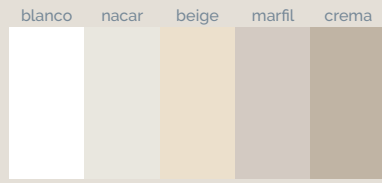

Naturally Made

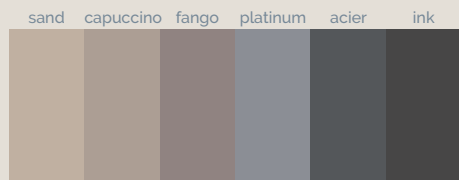

Season

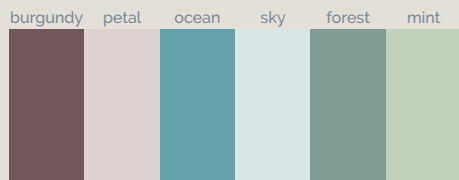

RaI/NCS



Dimensiones estándar (cm)

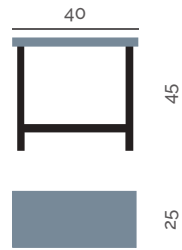

Ficha técnica de producto



Asiento a pared Show



Texturas

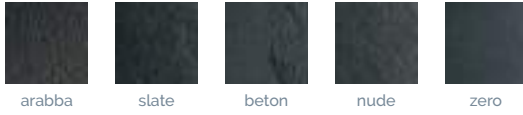

Colores

Standard



Naturally Made



Season

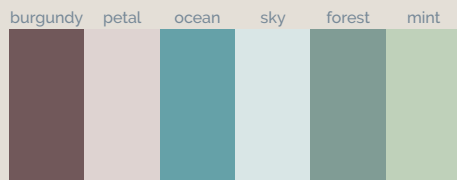

RaI/NCS



Dimensiones estándar (cm)

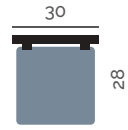

Ficha técnica
de producto



Manual de
instalación



Estante Box



Texturas

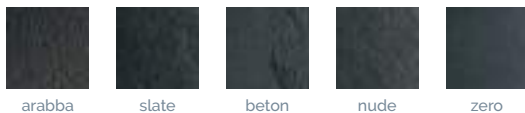

Colores

Standard

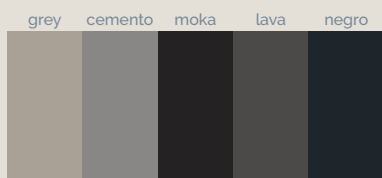
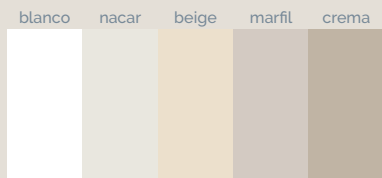

Naturally Made

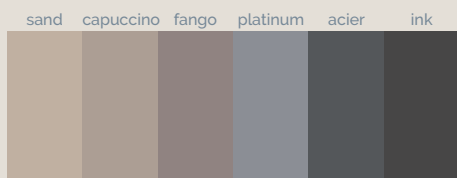

Season

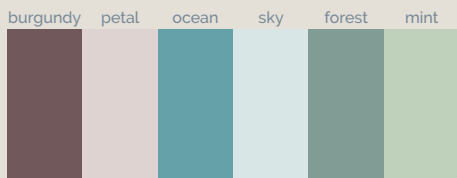

RaI/NCS



Dimensiones estándar (cm)

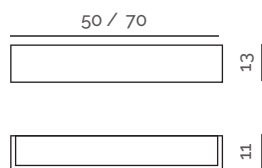

Ficha técnica
de producto



Manual de
instalación



Estante Show



Estante Show blanco Beton blanco · Panel Basic Beton crema 250x100 cm

Texturas

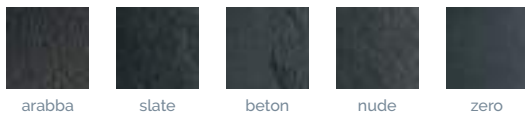

Colores

Standard

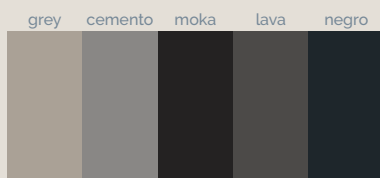
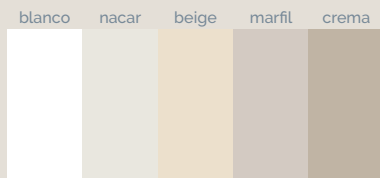

Naturally Made

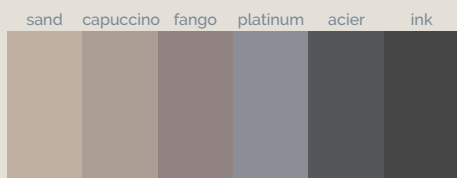

Season

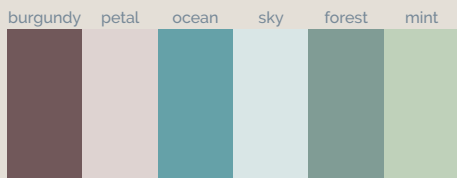

RaI/NCS



Dimensiones estándar (cm)

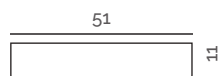

Ficha técnica
de producto



Manual de
instalación



Estante Corner Show



Estante Corner Show negro Slate lava - Panel Basic Slate marfil

Texturas

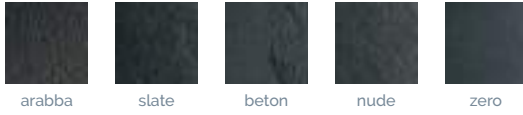

Colores

Standard

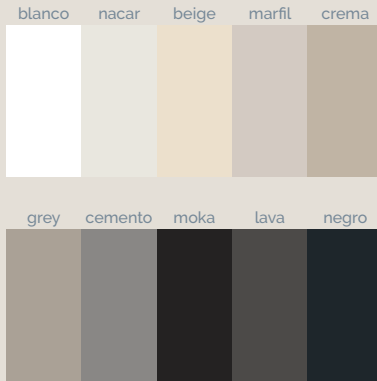

Naturally Made

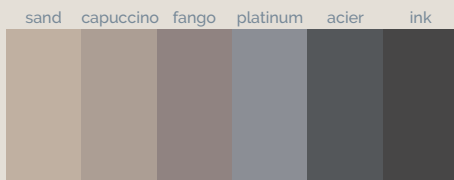

Season

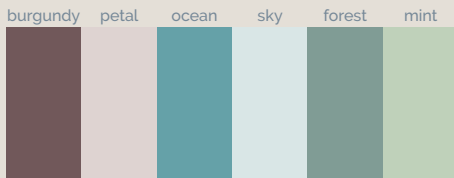

RaI/NCS



Dimensiones estándar (cm)

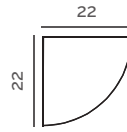

Ficha técnica
de producto



Manual de
instalación



Mueble Bastidor WC



Mueble bastidor WC Zero negro

Texturas

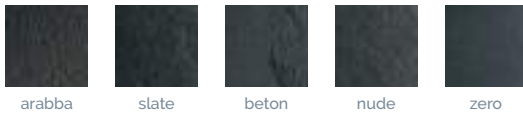

Colores

Standard



Naturally Made



Season

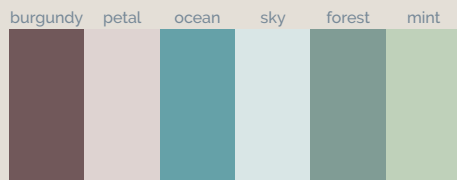

RaI/NCS



Dimensiones estándar (cm)

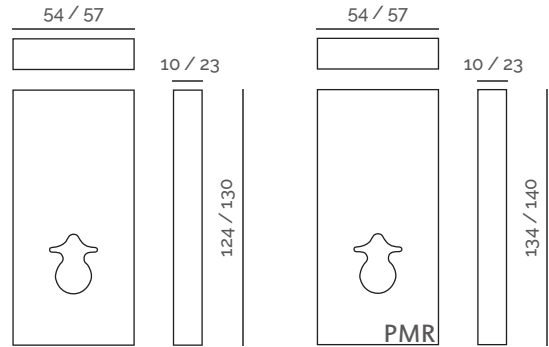

Ficha técnica
de producto



Manual de
instalación



Espejo Moon



Espejo Moon Slate crema · Lavabos Chrea · Encimera One CF Slate crema 200x50 cm · Paneles Basic Slate blanco 250x120 cm

Texturas

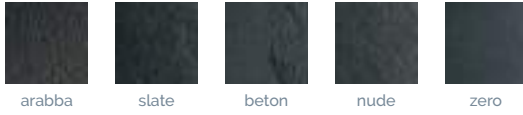

Colores

Standard

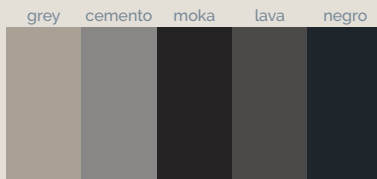
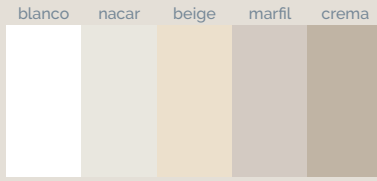

Naturally Made

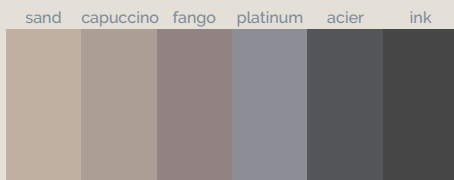

Season

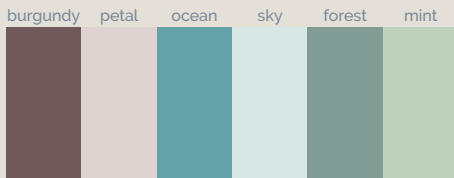

RaI/NCS



Dimensiones estándar (cm)

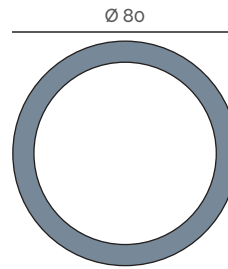

Ficha técnica
de producto



Manual de
instalación



Espejo Urban





Dimensiones estándar (cm)

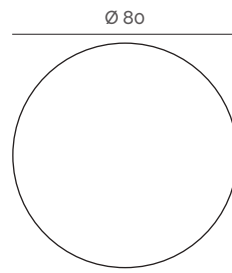

Ficha técnica
de producto



Manual de
instalación



Espejo Show



Espejos Show Slate cemento · Paneles Basic Slate crema 250x100 cm · Lavabos On-Top Square XL Slate cemento

Texturas

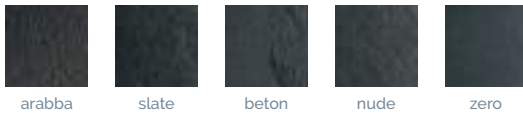

Colores

Standard

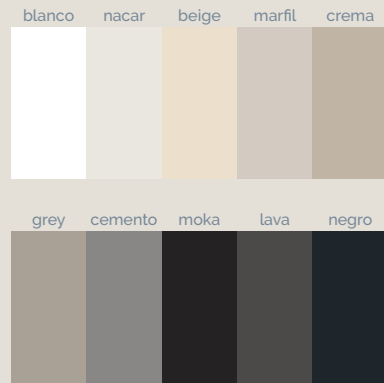

Naturally Made

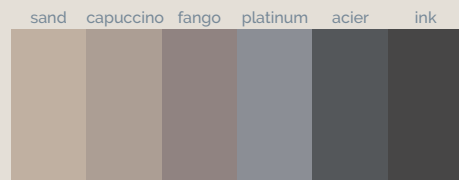

Season

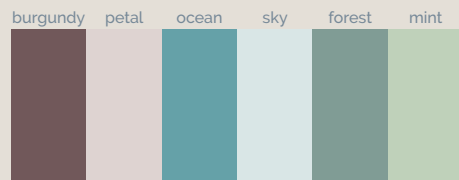

RaI/NCS



Dimensiones estándar (cm)

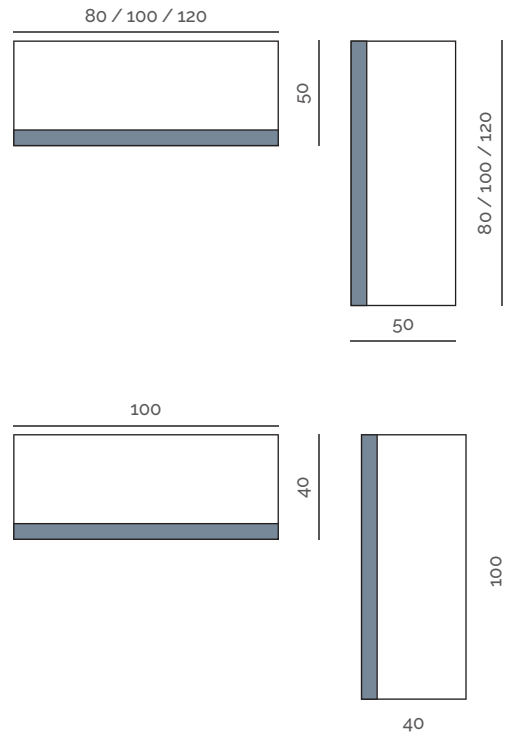

Ficha técnica
de producto



Manual de
instalación



Columna de ducha Kendo



Columna de ducha Kendo Slate NCS S 6010-B30G · Paneles Basic Slate blanco 240x100 cm · Estantes Show inox Slate NCS S 6010-B30G

Texturas

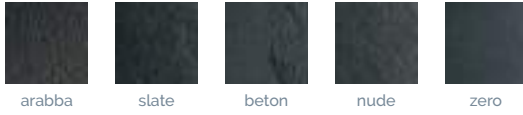

Colores

Standard



Naturally Made



Season

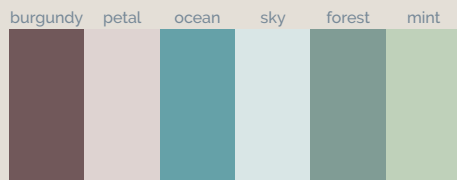

RaL/NCS



Dimensiones estándar (cm)

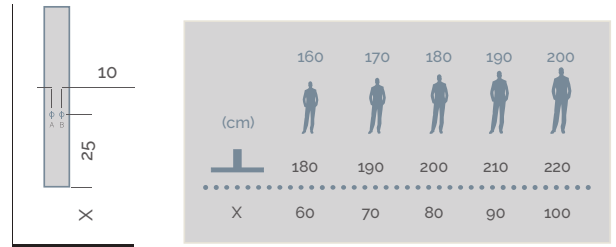
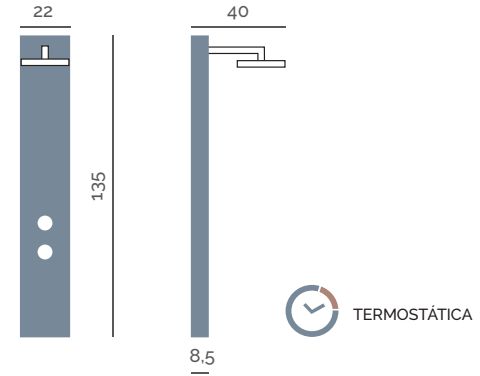

Ficha técnica de producto



Manual de instalación







Información técnica

<i>Desagües (mm) disponibles</i>	326
<i>Válvulas disponibles</i>	327
<i>Complementos platos de ducha</i>	328-329
<i>Complementos bañeras</i>	330-331
<i>Complementos tótems</i>	330-331
<i>Complementos encimeras</i>	332-333
<i>Complementos lavabos</i>	334-335
<i>Certificados Akron</i>	336-337
<i>Certificados Dolotek</i>	338
<i>Uso y mantenimiento</i>	339
<i>Características de productos Akron</i>	339-340
<i>Reparación</i>	341-342
<i>Condiciones generales de venta</i>	343-344

Desagües disponibles

PLATOS DE DUCHA

Estándar

Desagüe line estándar (mm)

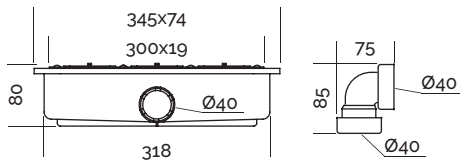

Desagüe estándar (mm)

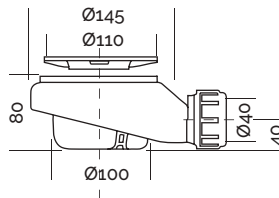

Desagüe estándar Ø 70 (mm)

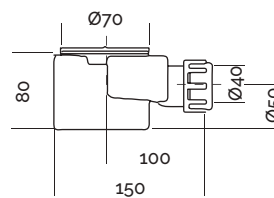

Opcional

Desagüe vertical (mm)

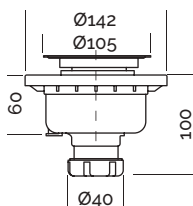

Desagüe vertical Ø 70 (mm)

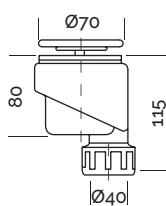

Desagüe extraplano (mm)

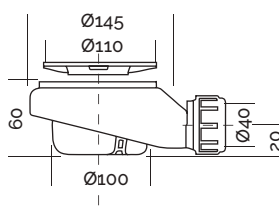

Desagüe de gran caudal (mm)

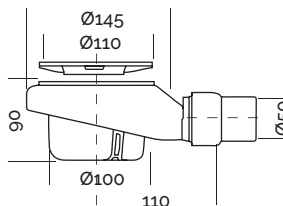

EN 274

NF

Desagüe line estándar

Desagüe estándar



Desagüe estándar Ø70



Desagüe vertical

Desagüe vertical Ø70

Desagüe extraplano

Desagüe gran caudal



BAÑERAS

Estándar

Desagüe estándar H98 (mm)

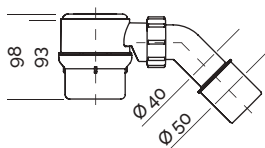

Desagüe estándar H79 (mm)

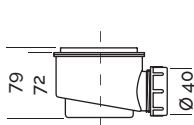

EN 274

NF

Desagüe estándar H98



Desagüe estándar H79



Válvulas disponibles

BAÑERAS

Válvula clic-clac Akron (mm)

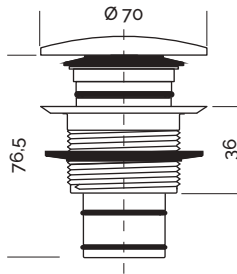

Válvula clic-clac cromo (mm)

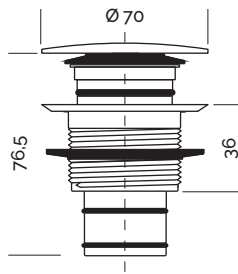

Válvula clic-clac Dolotek (mm)

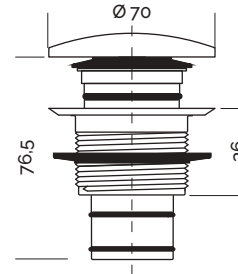

ENCIMERAS, LAVABOS Y TÓTEMOS

Válvula clic-clac Akron (mm)

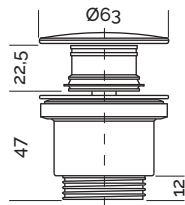

Válvula de salida libre Akron (mm)

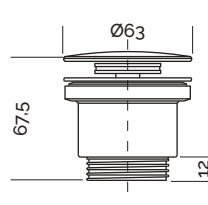

Válvula clic-clac cromo (mm)

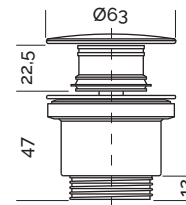

Válvula de salida libre cromo (mm)

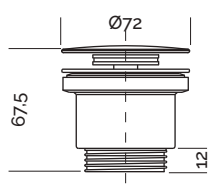

Válvula Pop Down cromo (mm)

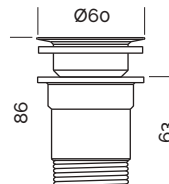

Válvula plana cromo (mm)

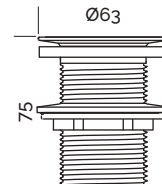

Válvula clic-clac con rebosadero cromo (mm)

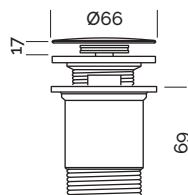

PLATOS DE DUCHA COMPLEMENTOS



	Standard	Nat. Made	Season	RaI/NCS	Base Slate	Base Beton	Base Zero	Base Nude
Desagüe line estándar								
Desagüe estándar					✓	✓	✓	✓
Desagüe estándar Ø70								
Desagüe vertical					✓	✓	✓	✓
Desagüe vertical Ø70								
Desagüe extraplano					🛒	🛒	🛒	🛒
Desagüe gran caudal					🛒	🛒	🛒	🛒
Moldura (5x4,1 cm)	📦	📦	📦	📦	🛒	🛒	🛒	🛒
Zona de secado	📦	📦	📦	📦	🛒			
Zócalo de elevación	📦	📦	📦	📦	🛒	🛒	🛒	🛒
Rejilla inox Base / Arq					✓	✓	✓	✓
Rejilla Akron Base / Arq (Mia, Geo, Lux)	📦	📦	📦	📦	✓	✓	✓	✓
Rejilla Akron Unic Slate (Deco, Dune, Drop)	📦	📦	📦	📦				
Tapa Akron Halo Slate	📦	📦	📦	📦				
Tapa Akron Areia Slate Evo	📦	📦	📦	📦				
Rejilla Akron Natur Wave	📦	📦	📦	📦				
Rejilla Akron Smart Quiz	📦	📦	📦	📦				
Tapa Akron Tempo Arabba	📦	📦	📦	📦				
Tapa Akron Flow Zero	📦	📦	📦	📦				
Rejilla Akron Focus Beton	📦	📦	📦	📦				
Embellecedor Focus Beton								
Rejilla inox Prisma Slate								

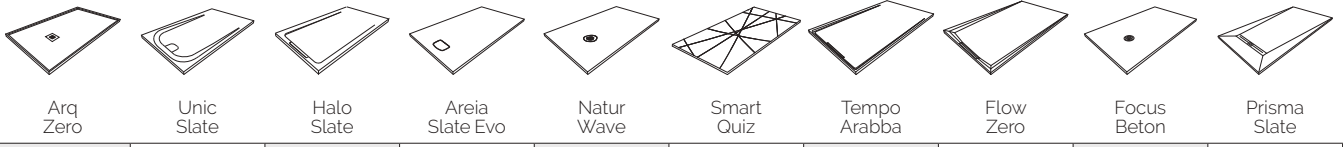

Arq Zero	Unic Slate	Halo Slate	Areia Slate Evo	Natur Wave	Smart Quiz	Tempo Arabba	Flow Zero	Focus Beton	Prisma Slate
		✓				✓	✓		
✓	✓		✓	✓	✓			✓	
									✓
✓	✓		✓	✓	✓			✓	
									✓
🛒	🛒		🛒	🛒	🛒			🛒	
🛒	🛒		🛒	🛒	🛒			🛒	
								🛒	🛒
	🛒	🛒	🛒						🛒
🛒	🛒	🛒				🛒	🛒	🛒	🛒
✓									
✓									
	✓								
		✓							
			✓						
				✓					
					✓				
						✓			
							✓		
								✓	
								✓	
									✓

BAÑERASCOMPLEMENTOS

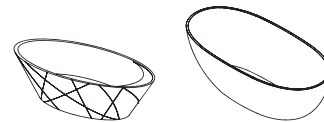

		Standard	Nat. Made	Season	Ral/NCS	Blanco mate	Opal Quiz	Lech
	Akron	☒	☒	☒	☒		✓	
	Dolotek					☒		✓
	Válvula clic-clac Akron	☒	☒	☒	☒		✓	
	Válvula clic-clac blanco					☒		✓
	Válvula clic-clac cromo							🛒
	Válvula clic-clac Dolotek					☒		
	Desagüe estándar H98						✓	✓
	Desagüe estándar H79							
	Rebosadero integrado						✓	
	Rebosadero cromo							
	Patas regulables							

TÓTEMSCOMPLEMENTOS



		Standard	Nat. Made	Season	Ral/NCS	Blanco mate	Icon	Levi
	Akron	☒	☒	☒	☒		✓	
	Dolotek					☒		✓
	Válvula clic-clac Akron cromo / negro	☒	☒	☒	☒		🛒	
	Válvula de salida libre Akron cromo / negro	☒	☒	☒	☒		🛒	
	Válvula clic-clac cromo con rebosadero							🛒
	Válvula Pop Down cromo							
	Válvula plana cromo							
	Tapa Dolotek					☒		
	Sistema de fijación						✓	✓
	Rebosadero							✓



Nevis

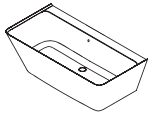

Dewa



Voss



Chrea

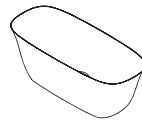

Levi

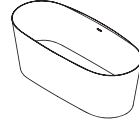

Vars



Venet



Boreal

✓	✓	✓	✓	✓	✓	✓	✓
				✓			
				🛒			
✓	✓	✓	✓		✓	✓	✓
	✓	✓	✓	✓	✓	✓	✓
✓							
			✓		✓	✓	✓
	✓	✓					
✓	✓			✓	✓		✓



Vars

✓
🛒
🛒
✓

ENCIMERAS COMPLEMENTOS

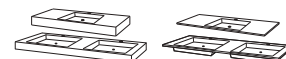

		Standard	Nat. Made	Season	Ral/NCS	Blanco mate	Integra CF Integra 2 CF	Integra SF Integra 2 SF
	Akron	☑	☑	☑	☑		☑	☑
	Dolotek					☑		
	Lavabo 42 (30 x 42 cm)	☑	☑	☑	☑			
	Lavabo 52 (30 x 52 cm)	☑	☑	☑	☑			
	Lavabo 52 Round (30 x 52 cm)	☑	☑	☑	☑			
	Lavabo 62 (30 x 62 cm)	☑	☑	☑	☑			
	Lavabo 50 (26,7 x 50 cm)	☑	☑	☑	☑		☑	☑
	Lavabo 104 (26,7 x 104 cm)	☑	☑	☑	☑			
	Lavabo 38 (23,4 x 38 cm)	☑	☑	☑	☑			
	Lavabo 55 (31,5 x 55,1 cm)					☑		
	Copete	☑	☑	☑	☑		☑	☑
	Sistema de fijación						☑	
	Toallero / Sistema de fijación							
	Toallero Show frontal (40 x 4 cm)						🛒	
	Toallero Show derecho (40 x 4 cm)							
	Toallero Show izquierdo (40 x 4 cm)							
	Toallero Moiwa (50 x 5 cm)							
	Válvula clic-clac Akron cromo / negro	☑	☑	☑	☑		🛒	🛒
	Válvula de salida libre Akron cromo / negro	☑	☑	☑	☑		🛒	🛒
	Válvula clic-clac cromo							
	Válvula de salida libre cromo							
	Válvula Pop Down cromo							
	Válvula plana cromo							



Integra CF
120XL

Integra SF
120XL

Infinity CF
Infinity 2 CF

Infinity CFR
Infinity 2 CFR

Infinity SF
Infinity 2 SF

One CF

One CFR

One SF

Mini

Moiwa

✓	✓	✓	✓	✓	✓	✓	✓	✓	
									✓
		✓	✓	✓					
		✓	✓	✓					
		✓	✓	✓					
		✓	✓	✓					
✓	✓								
								✓	
									✓
✓	✓	✓	✓	✓	✓	✓	✓		
✓		✓	✓		✓	✓		✓	✓
								✓	
🛒		🛒			🛒				
		🛒			🛒				
		🛒			🛒				
									✓
🛒	🛒	🛒	🛒	🛒				🛒	
🛒	🛒	🛒	🛒	🛒				🛒	
									🛒
									🛒
									🛒
									🛒

LAVABOS COMPLEMENTOS

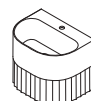

		Standard	Nat. Made	Season	RaI/NCS	Blanco mate	Delia	On-Top Circle
	Akron	Disponible	Disponible	Disponible	Disponible		Incluido	Incluido
	Dolotek					Disponible		
	Válvula clic-clac Akron cromo / negro	Disponible	Disponible	Disponible	Disponible		Opcional	Opcional
	Válvula de salida libre Akron cromo / negro	Disponible	Disponible	Disponible	Disponible		Opcional	Opcional
	Válvula clic-clac cromo							
	Válvula de salida libre cromo							
	Válvula clic-clac Dolotek cromo					Disponible		
	Válvula Pop Down cromo							
	Válvula plana cromo							
	Tapa Dolotek					Disponible		



		Standard	Nat. Made	Season	RaI/NCS	Blanco mate	Levi Circle XL	Levi Rectangle
	Akron	Disponible	Disponible	Disponible	Disponible			
	Dolotek					Disponible	Incluido	Incluido
	Válvula clic-clac Akron cromo / negro	Disponible	Disponible	Disponible	Disponible			
	Válvula de salida libre Akron cromo / negro	Disponible	Disponible	Disponible	Disponible			
	Válvula clic-clac cromo						Opcional	Opcional
	Válvula de salida libre cromo						Opcional	Opcional
	Válvula clic-clac Dolotek cromo					Disponible		
	Válvula Pop Down cromo						Opcional	Opcional
	Válvula plana cromo						Opcional	Opcional
	Tapa Dolotek					Disponible		



On-Top Circle XL



On-Top Square



On-Top Square XL



On-Top Oval



On-Top Oval XL



On-Top Rectangle



On-Top Rectangle XL



Chrea

✓	✓	✓	✓	✓	✓	✓	
							✓
🛒	🛒	🛒	🛒	🛒	🛒	🛒	
🛒	🛒	🛒	🛒	🛒	🛒	🛒	
							✓



Levi Rectangle XL



Vars Circle



Vars Circle XL



Vars Square XL



Vars Rectangle XL



Venet Circle



Venet Circle XL



Venet Square



Venet Rectangle

✓	✓	✓	✓	✓	✓	✓	✓	✓
🛒					🛒	🛒	🛒	🛒
🛒					🛒	🛒	🛒	🛒
🛒	🛒	🛒	🛒	🛒	🛒	🛒	🛒	🛒
🛒	🛒	🛒	🛒	🛒	🛒	🛒	🛒	🛒
	✓	✓	✓	✓				

Certificados Akron

CERTIFICADO SISTEMA DE GESTIÓN

Sistema de gestión de	Actividades	Resultado	Norma
Construplas, S.L.U.	Diseño, fabricación y venta de platos de ducha y accesorios de baño	✓	ISO 9001:2015
	Diseño, fabricación y venta de platos de ducha	✓	ISO 14001:2015
	Diseño, fabricación y venta de platos de ducha. Diseño y venta de accesorios de baño	✓	ISO 45001:2018

EVALUACIÓN DE LA CONFORMIDAD DE LOS PLATOS DE DUCHA DE USO DOMÉSTICO *

Producto	Ensayo	Resultado	Norma
Plato de ducha	Aptitud para la limpieza	✓	UNE EN 14527:2016 + A1:2019
	Estabilidad del fondo	✓	
	Resistencia química	✓	
	Resistencia a las variaciones de temperatura	✓	

* Para los fines de la norma UNE-EN 14527:2016 + A1:2019, el término "uso doméstico" incluye la utilización en hoteles, residencias de estudiantes, hospitales y edificios similares.

DETERMINACIÓN DE LAS PROPIEDADES ANTIDESLIZANTES

Producto	Ensayo	Realizado	Norma
Plato de ducha	Ángulo crítico de deslizamiento. Zonas húmedas de andar descalzo	✓	UNE EN 16165:2022 Anexo A

REQUISITOS FUNCIONALES APARATOS SANITARIOS

Producto	Ensayo	Resultado	Norma
Encimera	Resistencia a la carga	✓	UNE EN 14688:2016 + A1:2019
	Evacuación de agua	✓	
	Resistencia a los cambios de temperatura	✓	
	Resistencia a los agentes químicos y colorantes	✓	
	Aptitud para la limpieza	✓	

EVALUACIÓN DE LA CONFORMIDAD DE LAS BAÑERAS DE USO DOMÉSTICO

Producto	Ensayo	Resultado	Norma
Bañera	Aptitud para la limpieza	✓	UNE EN 14516:2017 + A1:2019
	Estabilidad del fondo de la bañera	✓	
	Resistencia a los agentes químicos y colorantes	✓	

ENSAYOS DE RESISTENCIA

Tipo	Reactivo	Resultado	Norma
Ácidos	Ácido acético (CH ₃ COOH) 10% v/v	✓	UNE EN 14527:2016 + A1:2019
Álcalis	Hidróxido sódico (NaOH) 5% v/v	✓	
Alcoholes	Etanol (C ₂ H ₅ OH) 70% v/v	✓	
Decolorantes	Hipoclorito sódico (NaOCl) con 5% de cloro libre (Cl ₂)*	✓	
Agentes colorantes	Azul de metileno 1% m/m	✓	

* El decolorante anteriormente especificado puede sustituirse por percarbonato sódico (2Na₂CO₃ · 3H₂O₂) preparado como sigue: Se disuelve 1g de un decolorante en polvo disponible comercialmente a base de percarbonato sódico que contenga del 15% al 30% del componente activo en 100ml de agua desionizada a temperatura ambiente.

Certificados Dolotek

NÚMEROS DE DECLARACIONES DE PRESTACIONES - REGLAMENTO (UE) N° 305/2011 ANEXO III *

Producto	Características esenciales	Resultado	Norma
Lavabo / Tótem / Encimera	Facilidad de limpieza	✓	EN 14688:2006 DoP: 400/04/13
	Resistencia de carga		
	Desagüe		
	Durabilidad		
Producto	Características esenciales	Resultado	Norma
Bañera	Facilidad de limpieza	✓	EN 14527:2006+A1:2010 DoP 402/02/13
	Durabilidad		

* Los ensayos se realizaron en el Instituto de Técnicas de la Construcción, miembro de la Organización Europea para la Evaluación Técnica (EOTA, European Organisation of Technical Assessment, en inglés).

RESISTENCIA AL FUEGO *

Propiedad	Clasificación	Criterios de clasificación	Método de ensayo	Norma
Clasificación europea de reacción al fuego	E	$F_s \leq 150\text{mm}$ en 20 s	EN ISO 11925-2L 15 s de exposición	EN 13501-1:2007 A1:2009

* Los ensayos se realizaron en el Instituto de Técnicas de la Construcción, miembro de la Organización Europea para la Evaluación Técnica (EOTA, European Organisation of Technical Assessment, en inglés).

RESISTENCIA A CAMBIOS DE TEMPERATURA *

Producto	Aprobación del documento	Resultado	Norma
Lavabo / Tótem / Encimera	LZE03-01224/17/R31NZE	✓	Norma europea EN 14688
Bañera	LZE03-01224/17/R31NZE	✓	Norma europea EN 14516

* Los ensayos se realizaron en el Instituto de Técnicas de la Construcción, miembro de la Organización Europea para la Evaluación Técnica (EOTA, European Organisation of Technical Assessment, en inglés).

RESISTENCIA A REACTIVOS QUÍMICOS Y COLORANTES *

Tipo	Reactivo	Método de eliminación	Efecto	Resultado	Norma
Ácidos	Ácido acético (CH ₃ COOH) 10% v/v	Agua desionizada	No se han detectado despigmentación (manchas) ni deterioro de la superficie útil	✓	EN 14688:2066
Álcalis	Hidróxido sódico (NaOH) 5% v/v			✓	
Alcoholes	Etanol (C ₂ H ₅ OH) 70% v/v			✓	
Preparaciones para blanquear	Hipoclorito de sodio (NaOCl) 5% de cloro activo (Cl ₂)			✓	
Agentes decolorantes	Azul de metileno 1% m/m			✓	
Sales	Cloruro de sodio (NaCl) 170 g/l, diluido en agua al 50%			✓	

* Esta prueba se ha realizado según lo especializado en el párrafo 5,5 de la norma europea EN 14688:2006, utilizando todos los reactivos químicos indicados en la Tabla 2 del presente documento.

Uso y mantenimiento

AKRON

Para disfrutar de su plato de ducha durante muchos años siga estos sencillos consejos:

Para la limpieza rutinaria basta con enjuagar con un paño suave de algodón (no abrasivo) el plato con agua. **NUNCA UTILIZAR ESTROPAJOS (SCOTCH BRITE, ni de FIBRAS NATURALES), ni DISOLVENTES, ÁCIDOS, ÁLCALIS O CON ABRASIVOS.** Después de utilizar cualquier producto de limpieza es necesario enjuagar de forma abundante con agua y jabón el plato con la finalidad de eliminar los posibles restos de productos de

limpieza y asegurar una ventilación suficiente del cuarto de baño.

Evitar todo contacto con lacas, quitaesmaltes de uña, disolventes orgánicos, alcoholes, ácidos, alcalis, etc.

Si utiliza tintes de pelo, enjuague el plato de ducha con agua y jabón una vez terminada la ducha.

Para eliminar los posibles restos de cal que pueda quedarse en el plato, podemos utilizar un antical doméstico (VIKAL) rebajando con agua 1:3 (1 L de Viakal por 3 L de agua) del siguiente modo:

- Retirar la rejilla inox del desagüe y aplicar con un paño húmedo por toda la superficie.

- Dejar actuar 15 minutos y transcurrido ese tiempo enjuagar con abundante agua.

- Volver a colocar la rejilla y enjuagar de nuevo el plato con agua.

No es recomendable para el uso de exteriores.

DOLOTEK

Para disfrutar de su producto durante muchos años siga estos sencillos consejos:

1. Para una limpieza regular se recomiendan productos de limpieza universales sin propiedades abrasivas.

2. Después de cada uso, enjuagar la superficie interior con agua y secar con un paño de algodón. No usar trapos sintéticos o de microfibra porque pueden rayar la superficie.

3. Para eliminar la cal use vinagre diluido con agua.

4. Limpiar manchas persistentes con agua tibia y detergentes suaves o agua con jabón. Para casos concretos (como tinte de pelo o laca de uñas) utilizar quitaesmalte o acetona. Finalmente, aclarar abundantemente con agua.

ATENCIÓN: Solamente en caso de arañazos superficiales o manchas persistentes, se recomienda usar un estropajo verde (Scotch Brite o similar) o una esponja abrasiva. Nunca utilizar sobre el logotipo.

Características de productos Akron

CONDICIONES DE ENTREGA

Todos los platos son embalados individualmente acorde con las dimensiones del plato. El embalaje contiene además del plato y sus protecciones:

1/ Instrucciones de montaje en varios idiomas, 2 / Rejilla de acero inoxidable AISI-304 pulido y cortado a láser de alta precisión, diseño exclusivo de Acquabella, para su colocación en el alojamiento del sifón. 3 / Todos nuestros platos son suministrados con una válvula sifónica de desagüe de altísima calidad que cumple con todas las normativas europeas. No se aceptan reclamaciones por daño una vez firmado el POD.

CONDICIONES DE USO Y MANTENIMIENTO

Siguiendo estas sencillas instrucciones podrá disfrutar de su plato de ducha Akron de Acquabella durante muchos años. Para la limpieza rutinaria basta con enjuagar el plato con agua y asegurar una ventilación suficiente del cuarto de baño.

Para una limpieza más cuidadosa, se debe enjuagar el plato con agua y jabón comercial PH neutro y una esponja no abrasiva (no usar estropajos ásperos). **EVITAR EL USO DE PRODUCTOS DE LIMPIEZA DESINFECTANTES QUE CONTENGAN DISOLVENTES O ÁCIDOS ASÍ COMO ESTROPAJOS O TRAJOS ABRASIVOS.**

Es importante proteger el plato de ducha durante la instalación del mismo contra posibles golpes y arañazos. Esta protección también evitará que sobre la superficie del plato caigan restos de mortero, cemento o cualquier otra sustancia utilizada para la colocación del alicatado o del plato.

Por favor, sea especialmente cuidadoso con la pasta especial para el rejuntado de los azulejos, ya que esta contiene resinas y cales que al impregnarse sobre el plato y resecarse en él, pueden dejar incrustaciones difíciles de limpiar. Para evitar este problema recomendamos enjuagar con **ABUNDANTE** agua, evitando que estos se queden sobre la superficie del plato.

Si aun así aparecieran manchas causadas por incrustaciones de cemento o pasta de rejuntado sobre el plato, al finalizar la obra se debe utilizar DETERDEK de la casa FILA.

PEDIDOS DE PLATOS ESPECIALES

Los platos Akron, a excepción de los modelos Arq y Flow, pueden suministrarse a medida.

No es posible realizar curvas, arcos o formas similares, ya que los cortes deben ser siempre rectos.

Al realizar un pedido es importante tener en cuenta: 1/ Indicar el largo final del plato en cm.(si se desea cortar la longitud). 2/ Indicar la anchura final del plato en cm. (si se desea cortar la anchura). 3/ Dibujar el croquis con las medidas y forma del plato.

Los cortes pueden servirse pintados del mismo color que el plato a petición expresa del cliente, pero la zona cortada pierde, como es lógico la textura.

COLOCACIÓN DE PANELES DE SUSTITUCIÓN Y ZÓCALOS DE ELEVACIÓN

Esta colocación se completa con paneles de pared para alicatar y zócalos de sobreelevación que pueden ser fabricados bajo pedido. Los elementos AKRON pueden ser cortados utilizando amoladoras o sierras circulares de disco de diamante o similares a las usadas en albañilería.

El pegado y sellado de los distintos elementos debe realizarse utilizando ULTRABOND o similares y el sellado con silicona no ácida.

INSTRUCCIONES PARA LA REPARACIÓN DE UN PLATO AKRON

Es posible reparar el color de un plato Akron si por algún motivo la superficie de este se hubiera deteriorado por un uso indebido del mismo. En estos casos, se puede pedir un Kit de Reparación que debe ser requerido especificando el color del plato a reparar.

Para aplicar la laca poliuretánica reparadora, previamente desengrasar la zona afectada con alcohol de limpieza. Aplicar la pintura con un rodillo de lacar y dejar secar al menos 48/72h sin utilizar el plato ni tocar la zona afectada.

FAQ'S (PREGUNTAS FRECUENTES)

-¿Qué herramientas usar para el corte de platos y paneles?

Disco de diamante, similar al usado en corte de piedra, azulejos, ladrillos, etc.

-¿Qué productos he de usar para limpiar mis platos y encimeras AKRON de Acquabella?

Para la limpiar los posibles restos de cemento cola y mortero utilizaremos un desincrustante para juntas llamado DETERDEK de la casa FILA, Fuga-Soap ECO(KERAKOLL), ya que es específico para la eliminación de restos de obra, también se utiliza para la eliminación de otros componentes como el salitre, óxido y cal, leer las instrucciones de uso. NO FROTAR, dejar actuar el producto; NUNCA UTILIZAR ESTROPAJOS (SCOTCH BRITE, ni de FIBRAS NATURALES), ni DISOLVENTES, ÁCIDOS, ÁLCALIS O CON ABRASIVOS. Después de limpiar, aclarar con abundante agua y asegurar una ventilación suficiente del cuarto de baño. No es peligroso para el usuario ni para el medio ambiente.

-¿Cuáles son las características y dimensiones del sifón?

La válvula es de tipo sifónico y dispone de una unidad de extracción propia para la limpieza, a la cual se accede quitando la rejilla ACQUABELLA. Esta pieza es la encargada de realizar el efecto sifón, motivo por el cual debe ser retirada cuando exista un segundo sifón o bote sifónico, ya que de lo contrario el agua NO EVACUARÁ.

-¿Qué material he de usar para pegar o sellar paneles y platos AKRON de Acquabella?

El pegado de los distintos elementos debe realizarse utilizando ULTRABOND o SIKABOND T2 (Sika), SUPERFLEX (Kerakoll) y el sellado con silicona no ácida.

-¿Que espesor tienen los paneles de pared que pueden acompañar a los platos AKRON de acquabella?

Los paneles tienen un espesor de 6mm. Los paneles 3D tienen un espesor mínimo de 6mm y uno máximo de 10mm.

-¿Qué dimensiones tienen los zócalos para sobre elevación de los platos AKRON de Acquabella?

Los zócalos de elevación tienen una altura de 9 cm. Que es la altura del desagüe sifónico de los platos AKRON.

¿A quién solicitar recambios-componentes de los platos AKRON de Acquabella?

Para solicitar recambios o repuestos deberá solicitar respuesta a nuestro departamento comercial.

¿Existe material promocional de los platos Acquabella?

Para la exposición de los platos Akron de Acquabella, existe un expositor especial para la exposición de 2 platos de ducha a medida.

Reparación

KIT DE REPARACIÓN AKRON

Para una correcta aplicación del kit de reparación Akron, debe de seguir las siguientes recomendaciones:

ADECUACIÓN ZONA A REPARAR:

1. Limpiar muy bien la superficie del plato. Puede aplicarse para este proceso alcohol de quemar o acetona diluida en agua con un trapo que no deje ningún tipo de pelusa.
2. La superficie debe estar totalmente limpia y seca.
3. Proteger con cinta de carroceros o similar, las zonas susceptibles de mancharse (azulejos, mamparas, etc)

MODO DE APLICACIÓN:

4. Abrir los recipientes.
5. Verter la laca coloreada y el catalizador sobre una cubeta plástica pequeña de pintor y mezclar.
6. Utilizar un rodillo de lana para pintar de 8 o 10 cm. de buena calidad, ejerciendo trazos largos y siempre en el mismo sentido, reiterando lo necesario. Es importante que no suelte restos de pelusas.
7. En función del estado a restaurar, es posible que necesite aplicar varias manos de pintura. Para ello deje secar entre una y otra al menos 40 minutos antes de aplicar la siguiente mano.
8. Finalmente dejar secar 48 horas antes de retirar la cinta de carroceros de protección.



Kit de reparación Akron



NOTA: un kit cubre una superficie máxima de 140x100 cm.

MINI KIT DE REPARACIÓN AKRON

Es posible reparar pequeños defectos ocasionados en un plato AKRON de Acquabella. Si por algún motivo la superficie de éste se hubiera deteriorado por una mala instalación o un uso indebido del mismo, se puede solicitar un MINI Kit de reparación que debe ser requerido especificando la textura y el color del plato a reparar. EL KIT CONSTA DE UN RECIPIENTE Y ESTÁ PENSADO PARA PEQUEÑAS REPARACIONES SUPERFICIALES. ATENCIÓN: PUEDEN HABER PEQUEÑAS VARIACIONES DE TONALIDAD RESPECTO AL COLOR ORIGINAL.

Procedimiento para la reparación de un plato:

1. Limpiar muy bien la superficie del plato. Puede aplicarse para este proceso alcohol de quemar o acetona diluida en agua con un trapo que no deje ningún tipo de pelusa.
2. La superficie debe estar totalmente limpia y seca.
3. Abrir el recipiente.
4. Remover con el pincel.
5. Utilizar el pincel para pintar la superficie a reparar.
6. Finalmente dejar secar 48 horas.



Mini kit de reparación Akron



KIT DE REPARACIÓN DE MASILLA

INSTRUCCIONES PARA LA REPARACIÓN SUPERFICIAL DE UN PLATO DE DUCHA AKRON DE ACQUABELLA

Es posible reparar la superficie de un plato AKRON de Acquabella si por algún motivo la superficie de éste se hubiera deteriorado por un uso indebido del mismo. En estos casos se puede solicitar un Kit de reparación de masilla. El kit consta de dos recipientes, A y B. Procedimiento para la reparación de un plato:

ADECUACIÓN ZONA A REPARAR:

1. Limpiar muy bien la superficie del plato. Puede aplicarse para este proceso alcohol de quemar o acetona diluida en agua con un trapo que no deje ningún tipo de pelusa.
2. La superficie debe estar totalmente limpia y seca.
3. Acotar con cinta de carroceros o similar la zona a reparar.

MODO DE APLICACIÓN:

4. Abrir los recipientes.
5. Mezclar los componentes de los recipientes A y B sobre una paleta.
6. Extender la masilla sobre la superficie a reparar.
7. Dejar secar 30 minutos, aproximadamente a 20°C. Una vez seco retirar la cinta de carroceros.
8. Simular la textura del plato con una lija. Retirar la suciedad y limpiar la zona.
9. Pintar el plato con un Kit de reparación. A partir de este punto seguir las instrucciones del manual del Kit de reparación.



Kit de reparación de masilla



KIT DE REPARACIÓN DOLOTEK

El presente kit sirve para la reparación de daños y arañazos. Es recomendable que sea aplicado por un profesional. El kit contiene todos los componentes necesarios para realizar la reparación, y garantizar una calidad y acabado profesional.

Adecuación de la zona a reparar:

1. Retirar los restos sueltos de la superficie dañada con la ayuda de un cúter o herramienta afilada. Aplicar alcohol de quemar para retirar los restos de polvo suelto, con un trapo de algodón que no deje ningún tipo de pelusa.
2. La superficie debe quedar totalmente limpia y seca.
3. Proteger con cinta de carroceros la zona perimetral de la parte dañada.

Modo de aplicación:

1. Protegerse las manos con guantes y usar mascarilla.
2. Verter el bote B (Pipeta) en el bote A y remover con la espátula durante unos 30 segundos hasta que quede todo bien mezclado.
3. Utilizar inmediatamente la masa en la superficie dañada, con ayuda de la espátula. Debe aplicar material en exceso, dejando relieve. Dejar secar durante al menos 6 horas.
4. Retirar la cinta de carroceros y humedecer las lijas antes de emplearlas. Primero, usar la lija roja con ayuda del bloque blanco como soporte y lijar insistentemente la superficie dañada con pequeños círculos. Luego, repetir el mismo proceso con la lija de color gris.
5. Para un mejor acabado final dar una mano ligera con un estropajo verde (Scotch Brite o similar) a toda la superficie.

*El Kit de reparación tiene una fecha de caducidad de 3 meses desde la fecha que aparece en el envase.

ATENCIÓN: Puede haber pequeñas variaciones de tonalidad respecto al color original. Los kits de reparación se deben almacenar en un lugar fresco y seco, y también fuera del alcance de los niños.



Kit de reparación Dolotek



Condiciones generales de venta

Las condiciones que se expresan a continuación son aplicables a todos los pedidos/contratos y por tanto se consideran que éstas son conocidas y aceptadas por el comprador a transmitir el pedido.

Todos los pedidos efectuados por nuestros Agentes, Representantes, Vendedores u otros se considerarán válidos sólo cuando esto sean enviados a Construplas S.L.U. en soporte papel o electrónico imprimible independientemente del formato.

PRECIOS

Nuestros precios públicos pueden variar tras la notificación al comprador. Los nuevos precios se aplicarán a todos los pedidos realizados a partir de la fecha de modificación. Se aplicará en la factura y en los precios netos el impuesto actualmente en vigor, el I.V.A., y cualquier otro impuesto por la ley.

En el caso de que la mercancía sea entregada por nosotros de acuerdo con las condiciones de compra acordadas con el cliente, será para pedidos de 250 euros netos de compra mínima. Por debajo de esta cantidad, cobraremos un mínimo de 50 euros por el envío.

PERIODO DE VIGENCIA

Esta tarifa entra en vigor a partir de septiembre 2023 y hasta nuevo aviso, momento en el cual la nueva tarifa anula las anteriores y está sujeta a modificación sin previo aviso por Construplas S.L.U.

CATÁLOGOS, OFERTAS Y PEDIDOS

Los términos y condiciones de nuestros catálogos se proporcionan sólo a título informativo.

Los pedidos se consideran firmes desde el momento de su recepción, los cambios, modificaciones y cancelaciones no se consideran perjudiciales. Al realizar un pedido a Construplas S.L.U., se aceptan todas y cada una de las condiciones generales de venta relacionadas con esta lista de precios. Los descuentos que se aplicarán a las ventas de nuestros productos se harán de acuerdo con las condiciones establecidas con cada cliente. Las ofertas están siempre, y a todos los efectos, sujetas a nuestra posterior aceptación de la correspondiente orden escrita.

ANULACIONES/MODIFICACIONES DE PEDIDO

No se admitirán anulaciones ni variaciones de los pedidos una vez estos hayan entrado en fabricación, y en cualquier caso, en un periodo superior a 24 horas desde la recepción del pedido. En cualquier caso, estas modificaciones/anulaciones deberán ser remitidos a Construplas S.L.U. por escrito.

DEVOLUCIONES

No se admiten sin previa autorización por escrito de Construplas S.L.U. Solo se admitirán devoluciones de género cuando éstas hayan sido comunicadas y aceptadas por nuestro Dep. Comercial y siempre y cuando la mercancía sea recepcionada en perfecto estado de conservación. De su importe facturado se deducirá un porcentaje no inferior al 30 % en concepto de gastos de recepción, prueba e inspección y demérito.

Se enviarán franco portes a nuestra fábrica. Cuando se acepte una devolución de material, el abono correspondiente se efectuará después de la recepción, comprobación y evaluación del mismo por Construplas S.L.U.

ARTÍCULOS ESPECIALES – NO ESTÁNDAR

Los artículos con características o medidas especiales, diferentes a las marcadas en tarifa, serán consultados siempre a nuestro Dep. Comercial, el cual se encuentra a su disposición para realizar cualquier duda o aclaración.

CARACTERÍSTICAS Y DATOS TÉCNICOS DEL PRODUCTO

Toda la información técnica que aparece en esta tarifa es orientativa. Construplas S.L.U. se reserva el derecho a modificar todo aquello que considere oportuno siempre que no afecte a las características esenciales del producto recogido en esta tarifa.

TOLERANCIAS DIMENSIONALES

Debido a los materiales utilizados y al proceso de fabricación utilizado para todos nuestros productos Akron, estos podrían tener una tolerancia de $\pm 0,5\%$ con respecto a las dimensiones reales solicitadas. Para todos nuestros productos Dolotek, estos podrían tener una tolerancia de $\pm 1\%$ con respecto a las dimensiones reales solicitadas.

PLAZO DE ENTREGA

Todos los pedidos cursados son confirmados vía email o fax indicando el plazo orientativo de entrega. No se reconocerá ninguna indemnización de daños o intereses por los retrasos eventuales.

INSTALACIÓN Y MONTAJE

Es muy importante que tanto la instalación, como el montaje de los productos de Construplas S.L.U. sea realizados por personal cualificado y siguiendo las instrucciones que se suministran con los artículos.

ACEPTACIÓN DE PEDIDOS

La aceptación de los pedidos y de las condiciones de pago acordadas se encuentra supeditada al resultado de la información comercial que Construplas S.L.U. se reserva el derecho a obtener. El incumplimiento de los pagos, incluso tratándose de un solo plazo, dará el derecho a Construplas S.L.U. a suspender las entregas del resto de los pedidos en curso.

CONDICIONES DE PAGO

A negociar

IMPAGOS

En caso de impago o devolución de un giro bancario o similar, se retendrán los pedidos en curso hasta que se resuelva el problema.

GARANTÍA

Ver el apartado de CONDICIONES GENERALES DE NUESTRA GARANTÍA.

LITIGIOS/CONTROVERSIAS

Es voluntad de Construplas S.L.U. resolver por la vía amistosa las posibles divergencias que pudieran surgir con nuestros clientes. No obstante, para cualquier litigio o controversia que pudiera plantearse entre las partes en relación con la interpretación y cumplimiento

del presente contrato, ambas partes acuerdan someterse a un arbitraje de equidad en la Ley establecida en la Ley de arbitraje del 5 de diciembre de 1988 del Reino de España.

CONDICIONES GENERALES DE NUESTRA GARANTÍA

La garantía comercial, en adelante GC, ofrecida por Construplas S.L.U., será válida solo en el caso de haberse adquirido este artículo en países en países miembros de la UE. Las ventas efectuadas fuera de la UE no están bajo el amparo de esta garantía, salvo pacto expreso con Construplas S.L.U.

Esta GC no afecta a los derechos del consumidor respecto de las obligaciones del vendedor, de acuerdo con lo dispuesto en las respectivas leyes nacionales de trasposición de normativas Europeas.

Construplas S.L.U. garantiza sus artículos y componentes contra cualquier falta de conformidad, siempre y cuando los mismos hayan sido objeto de una correcta instalación (conforme a la normativa en vigor y observando las instrucciones), y se haya hecho el uso debido y para el que fueron concebidos. Siempre que la falta de conformidad se notifique a Construplas S.L.U. dentro de los 2 meses siguientes a su descubrimiento, el periodo de validez de esta GC para los consumidores finales será de 3 años desde el momento de la compra. Como excepción al párrafo anterior, el periodo de GC para todos los artículos que hayan sido expuestos en locales del distribuidor, vendedor, promotor o constructor, es de 1 año, sin perjuicio del periodo de garantía legal que otorga el vendedor.

El poseedor de esta GC deberá acreditar la vigencia de la misma, mediante la factura de la compra del artículo o la escritura de adquisición del inmueble donde se encuentre dicho artículo.

Esta garantía comercial no comprende:

- Los daños que se deriven del transporte (si este no ha sido realizado por Construplas S.L.U.) de una incorrecta instalación o montaje, de manipulaciones o reparaciones por personal no autorizado por Construplas S.L.U., así como los daños que se deban al desgaste natural, malos tratos, uso y mantenimiento incorrecto, impropio, anormal o diferente al usual y/o a lo indicado en las correspondientes instrucciones.
- Aquellos daños ocasionados por suciedad, incrustaciones, calcinación y otros defectos físicos, químicos o electroquímicos.
- Los daños que objetivamente no sean susceptibles de imputar al fabricante.

NOTA IMPORTANTE SOBRE LA GARANTÍA DE NUESTROS PLATOS DE DUCHA

Construplas S.L.U. garantiza el plato y se compromete a la reposición o reparación del mismo por cualquier defecto de fabricación.

Antes de terminar el alicatado y antes de colocar cualquier tipo de material sobre el mismo, el instalador deberá verificar la correcta instalación, y comprobar que el plato desagua perfectamente. En caso de no hacer correctamente esta verificación, Construplas S.L.U. no se hará cargo de los gastos de obra derivados de la sustitución del plato de ducha.

Los colores, datos, pesos y descripciones contenidas en este catálogo son orientativas. El aspecto del material podrá variar ligeramente del mostrado en las fotografías.
Construplas S.L.U. se reserva el derecho de añadir sin previo aviso y en cualquier momento o por cualquier motivo, todas las modificaciones que considere oportunas.
Queda totalmente prohibido cualquier reproducción, parcial o total no autorizada. Dicha violación será perseguida por la ley.

CONSTRUPLAS S.L.U. Pol. Ind. Belcaire Calle C Parcela 1201 · CP.12600 Vall d'Uixó (Castellón) España Tel. +34 964 66 19 19 Fax. +34 964 69 60 84 acquabella@construplas.com

